

Schema md-kh-standard_V07.00.xsd

schema location: I:\EDV-Projekte\VPS_XML\VPS-XML-08-18\A3-Systemanalyse\MD-KH\Schema\1.11 - 2\md-kh-standard_V07.00.xsd
attributeFormDefault: unqualified
elementFormDefault: qualified
targetNamespace: http://www.aok-systems.de/xml-schema/mdk-kh-standard_V07.00

Elements

[Beauftragung](#)
[Begutachtung](#)

schema location: I:\EDV-Projekte\VPS_XML\VPS-XML-08-18\A3-Systemanalyse\MD-KH\Schema\1.11 - 2\MD-basis-3.5.0.xsd
attributeFormDefault: unqualified
elementFormDefault: qualified
targetNamespace: MD:/xml-schema/MD-basis/3.5

Complex types

[Adressat Oder Adresse Ctp](#)
[Adresse Ctp](#)
[Aktenzeichen anderer Begutachtungsfall Ctp](#)
[Aktenzeichen Ctp](#)
[Arzt Ctp](#)
[Beratungsstelle MD Ctp](#)
[Dokument Ctp](#)
[Identifikationsmerkmal Ctp](#)
[Kasse Ctp](#)
[Kontaktdaten Ctp](#)
[Leistungserbringer Ctp](#)
[MD Ctp](#)
[Nebestelle Kasse Ctp](#)
[Person Ctp](#)
[SFB Standort Ctp](#)
[Versicherter Ctp](#)
[Vorherige SFB Ctp](#)

Simple types

[Abteilungstyp Stp](#)
[Abw Anschrift Stp](#)
[Aktenzeichen Stp](#)
[Anderer Adressat Stp](#)
[Anrede Stp](#)
[Anschriftenzusatz Stp](#)
[Anzahl2 Stp](#)
[Anzahl_0_14 Stp](#)
[Anzahl_1_13 Stp](#)
[Anzahl_1_99 Stp](#)
[Bes schutz Person Stp](#)
[BSNR Stp](#)
[Char10 Stp](#)
[Char20 Stp](#)
[Char25 Stp](#)
[Char28 Stp](#)
[Char30 Stp](#)
[Char50 Stp](#)
[Char80 Stp](#)
[Datum Stp](#)
[Decimal_7_2 Stp](#)
[Decimal_8_2 Stp](#)
[Decimal_8_3 Stp](#)
[Decimal_8_4 Stp](#)
[Diagnosensicherheit Stp](#)
[Dok Typ Stp](#)

Attr. groups

[vkz Grp](#)

[Email_Stp](#)
[Entgeltart_Stp](#)
[Entlassungsgrund_Stp](#)
[Fachabteilung_Stp](#)
[Facharztbezeichnung_Stp](#)
[Fallnummer_Stp](#)
[Freitext_Mit_Buchstaben_Stp](#)
[Freitext_Mit_Zeichen_Stp](#)
[Freitext_Mit_Zeilenum_10000_Stp](#)
[Freitext_Mit_Zeilenum_1000_Stp](#)
[Freitext_Mit_Zeilenumbrueche_Stp](#)
[Freitext_Ohne_Zeilenumbrueche_Stp](#)
[Gen_Geburtsdatum_Stp](#)
[Geschlecht_Stp](#)
[ICD_Schluesssel_Stp](#)
[ICD_Version_Stp](#)
[IK_Stp](#)
[Int10_Stp](#)
[Int1_Stp](#)
[Int2_Stp](#)
[Int3_Stp](#)
[Int4_Stp](#)
[Int5_Stp](#)
[Int7_Stp](#)
[Int8_Stp](#)
[Ja_Nein_Stp](#)
[Ja_Unbekannt_Stp](#)
[KV_PV_Nummer_Stp](#)
[KZV_Bereich_Stp](#)
[LANR_Stp](#)
[LKZ_Stp](#)
[Lokalisation_Stp](#)
[Mobiltelefon_Stp](#)
[Name_Stp](#)
[Namenszusatz_Stp](#)
[Nebenstellennummer_Stp](#)
[Ort_Stp](#)
[PLZ_Stp](#)
[Posnr_Stp](#)
[Postfach_Stp](#)
[Sachbearbeiter_Orga_Stp](#)
[Strasse_Hausnummer_Stp](#)
[TA_Version_Stp](#)
[Telefax_Stp](#)
[Telefon_Stp](#)
[Titel_Stp](#)

[Verfahrensart_Stp](#)
[Vorsatzwort_Stp](#)
[Zahnarzt_NR_Stp](#)
[Zeitbedarf_Stp](#)
[Zeitpunkt_kurz_Stp](#)
[Zeitpunkt_Stp](#)

schema location: I:\EDV-Projekte\VPS_XML\VPS-XML-08-18\A3-Systemanalyse\MD-KH\Schema\1.11 - 2\EMDK0-basis-3.0.0.xsd
attributeFormDefault: unqualified
elementFormDefault: qualified
targetNamespace: <http://www.aok-systems.de/xml-schema/EMDK0-basis-3.0.0>

Complex types

[CT_Antworten](#)
[CT_Fragestellung](#)
[CT_Neuer_Pruefanlass](#)
[CT_Pruefgegenstand](#)

Simple types

[Abrechnungsart](#)
[Antwortzeichen](#)
[Anzahl_Tage3](#)
[Art_Begutachtung](#)
[Arztnummer](#)
[Aufnahmearbeit](#)
[Aufnahmegrund](#)
[Auftragsart](#)
[Behandlungsart](#)
[Ber_Erw_Fragestellung](#)
[Berechtigung_Erweiterung_Pruefgegenstand](#)
[Bereitstellung_Unterlagen](#)
[Bezeichnung_Entgelt](#)
[Diagnosetyp](#)
[DRG](#)
[Entgeltart](#)
[Entlassungsgrund](#)
[Fachabteilung](#)
[Fall_ID](#)
[Frage_ID](#)
[Freitext_1024](#)
[Freitext_255](#)
[Freitext_512](#)
[Gutachtenart](#)
[IK_Stelle](#)
[Name_Stelle_Notfall](#)
[OPS_Schluesel](#)
[Pruefgegenstand](#)
[Rechnungsnummer](#)
[Rueckgabegrund](#)
[Schluesel_V_Stp](#)

[Verfahrenskennzeichen_Stp](#)

[Vorverf_Ergebnis](#)

[Wechsel_Auftragsart](#)

schema location: I:\EDV-Projekte\VPS_XML\VPS-XML-08-18\A3-Systemanalyse\MD-KH\Schema\1.11 - 2\GI4X-basis-2.0.0.xsd
attributeFormDefault: unqualified
elementFormDefault: qualified
targetNamespace: GI4X:/xml-schema/GI4X-basis/2.0

Complex types

[Anschrift_Ctp](#)

[Name_Ctp](#)

[Person_Ctp](#)

[UngenauesDatum_Ctp](#)

[Wurzel_Ctp](#)

Simple types

[BNR_Stp](#)

[BSNR_Stp](#)

[CentBetrag_Stp](#)

[Datum_Stp](#)

[Datum_Uhrzeit_Stp](#)

[EmailAdresse_Stp](#)

[EuroBetrag_Stp](#)

[Hausnummer_Stp](#)

[IK_Stp](#)

[ISO88591_Stp](#)

[ISO88591_Text_Stp](#)

[KVNR_Allgemein_Stp](#)

[KVNR_Alt_Stp](#)

[KVNR_Stp](#)

[Laenderkennzeichen_Stp](#)

[LANR_Stp](#)

[Logische_Version_Stp](#)

[Nachname_Stp](#)

[Namenstitel_Stp](#)

[Namensvorsatz_Stp](#)

[Namenszusatz_Stp](#)

[Ort_Stp](#)

[Postleitzahl_DE_Stp](#)

[Postleitzahl_Stp](#)

[Rufnummer_Stp](#)

[RVNR_Stp](#)

[StaatSchluessel_Stp](#)

[Strasse_Stp](#)

[Versichertenstatus_Stp](#)

[Vorname_Stp](#)

[Waehrung_Stp](#)

[Zahnarztnummer_Stp](#)

Attributes

[logische_version](#)

element Beauftragung

diagram

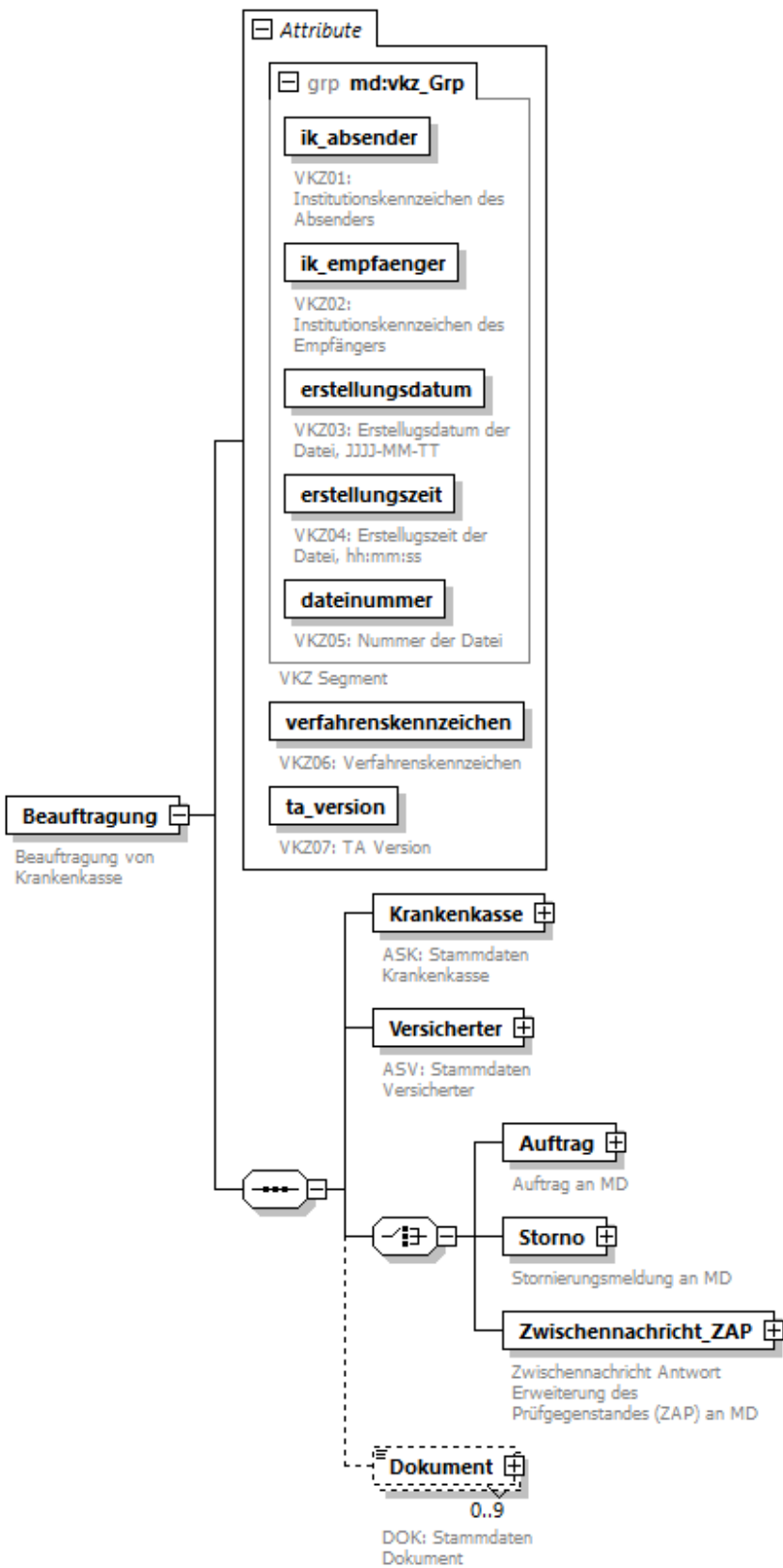

namespace	http://www.aok-systems.de/xml-schema/mdk-kh-standard_V07.00					
properties	content complex					
children	Krankenkasse Versicherter Auftrag Storno Zwischennachricht ZAP Dokument					
attributes	Name	Type	Use	Default	Fixed	Annotation
	ik_absender	IK_Stp	required			documentation VKZ01: Institutionskennzeichen des Absenders
	ik_empfaenger	IK_Stp	required			documentation VKZ02: Institutionskennzeichen des Empfängers
	erstellungdatum	Datum_Stp	required			documentation VKZ03: Erstellungsdatum der Datei, JJJJ-MM-TT
	erstellungzeit	Zeitpunkt_Stp	required			documentation VKZ04: Erstellungszeit der Datei, hh:mm:ss
	dateinummer	derived by: xs:positiveInteger	required			documentation VKZ05: Nummer der Datei
	verfahrenskennzeichen	Verfahrenskennzeichen_Stp	required			documentation VKZ06: Verfahrenskennzeichen
	ta_version	Schluessel_V_Stp	required			documentation VKZ07: TA Version
annotation	documentation Beauftragung von Krankenkasse					
source	<pre> <xs:element name="Beauftragung"> <xs:annotation> <xs:documentation>Beauftragung von Krankenkasse </xs:documentation> </xs:annotation> <xs:complexType> <xs:sequence> <xs:element name="Krankenkasse" type="md:Kasse_Ctp"> <xs:annotation> <xs:documentation>ASK: Stammdaten Krankenkasse</xs:documentation> </xs:annotation> </xs:element> <xs:element name="Versicherter" type="md:Versicherter_Ctp"> <xs:annotation> <xs:documentation>ASV: Stammdaten Versicherter</xs:documentation> </xs:annotation> </xs:element> <xs:choice> <xs:element name="Auftrag"> <xs:annotation> <xs:documentation>Auftrag an MD</xs:documentation> </xs:annotation> <xs:complexType> <xs:sequence> <xs:element name="Fragen" type="kh:CT_Fragestellung" minOccurs="0"> <xs:annotation> <xs:documentation>Fragestellungen der </pre>					

```

Krankenkasse</xs:documentati on>
  </xs:annotati on>
  <xs:uni que name="key_frage">
    <xs:sel ector xpath="kh: frage"/>
    <xs:fi el d xpath="@frage_ID"/>
  </xs:uni que>
</xs:el ement>
<xs:el ement name="Infos">
  <xs:annotati on>
    <xs:documentati on>Notwendige Informati onen</xs:documentati on>
  </xs:annotati on>
  <xs:compl exType>
    <xs:sequence>
      <xs:el ement name="Lei stungserbri nger"
type="md: Lei stungserbri nger_Ctp">
        <xs:annotati on>
          <xs:documentati on>SDL: Stammdaten
Lei stungserbri nger</xs:documentati on>
        </xs:annotati on>
      </xs:el ement>
      <xs:el ement name="Pruefgegenstaende"
type="kh: CT_Pruefgegenstand" mi nOccurs="0">
        <xs:annotati on>
          <xs:documentati on>PGS-Sätze:
Prüfgegenstand</xs:documentati on>
        </xs:annotati on>
        <xs:uni que name="key_preufgegenstand">
          <xs:sel ector xpath="kh: Pruefgegenstand"/>
          <xs:fi el d xpath="@pruefgegenstand"/>
        </xs:uni que>
      </xs:el ement>
      <xs:el ement name="Fal l daten">
        <xs:annotati on>
          <xs:documentati on>FKH-Satz</xs:documentati on>
        </xs:annotati on>
        <xs:compl exType>
          <xs:sequence>
            <xs:el ement name="Aufnahme">
              <xs:annotati on>
                <xs:documentati on>FKH01-05</xs:documentati on>
              </xs:annotati on>
              <xs:compl exType>
                <xs:attri bute name="tag" type="md: Datum_Stp"
use="requi red">
                  <xs:annotati on>
                    <xs:documentati on>FKH01: Datum
Krankenhaus-Aufnahme im Format (JJJJ-MM-TT)</xs:documentati on>
                  </xs:annotati on>
                </xs:attri bute>
                <xs:attri bute name="uhrzei t" type="xs: ti me"
use="requi red">
                  <xs:annotati on>
                    <xs:documentati on>FKH02: Uhrzei t
Krankenhaus-Aufnahme im Format (HH: MM: SS)</xs:documentati on>
                  </xs:annotati on>
                </xs:attri bute>
              </xs:el ement>
            </xs:sequence>
          </xs:el ement>
        </xs:compl exType>
      </xs:sequence>
    </xs:el ement>
  </xs:compl exType>
</xs:el ement>

```

```

</xs: attribute>
<xs: attribute name="aufnahmegrund" use="required">
  <xs: annotation>
    <xs: documentati on>FKH03: Aufnahmegrund
</xs: documentati on>
  </xs: annotation>
  <xs: simpleType>
    <xs: restricti on base="kh: Aufnahmegrund"/>
  </xs: simpleType>
</xs: attribute>
<xs: attribute name="aufnahmeanl ass"
type="kh: Aufnahmeanl ass" use="required">
  <xs: annotation>
    <xs: documentati on>FKH04: Aufnahmeanl ass
</xs: documentati on>
  </xs: annotation>
</xs: attribute>
<xs: attribute name="fachabtei lung"
type="kh: Fachabtei lung" use="required">
  <xs: annotation>
    <xs: documentati on>FKH05:
Fachabtei lung</xs: documentati on>
  </xs: annotation>
</xs: attribute>
</xs: complexType>
</xs: element>
<xs: element name="Entl assung" type="md: Datum_Stp"
mi nOccurs="0">
  <xs: annotation>
    <xs: documentati on>FKH06: Voraussi chtli ches
Entl assungsdatum im Format (JJJJ-MM-TT)</xs: documentati on>
  </xs: annotation>
</xs: element>
<xs: element name="Arztnummer" mi nOccurs="0">
  <xs: annotation>
    <xs: documentati on>FKH07: Arzt-Nummer des
ei nwei senden Arztes</xs: documentati on>
  </xs: annotation>
  <xs: simpleType>
    <xs: restricti on base="kh: Arztnummer"/>
  </xs: simpleType>
</xs: element>
<xs: element name="IK_Stel le" type="kh: IK_Stel le"
mi nOccurs="0">
  <xs: annotation>
    <xs: documentati on>FKH08: IK der veranl assenden
Stel le</xs: documentati on>
  </xs: annotation>
</xs: element>
<xs: element name="Stel le_Notfall "
type="kh: Name_Stel le_Notfall " mi nOccurs="0">
  <xs: annotation>
    <xs: documentati on>FKH09: Veranl assende Stel le bei
Notfall aufnahme</xs: documentati on>
  </xs: annotation>

```

```

</xs:element>
<xs:element name="Zahnarztnummer" minOccurs="0">
  <xs:annotation>
    <xs:documentation>FKH10: Arzt-Nummer des
ei nwei senden Zahnarztes</xs:documentation>
  </xs:annotation>
  <xs:simpleType>
    <xs:restriction base="kh:Arztnummer"/>
  </xs:simpleType>
</xs:element>
<xs:element name="Gewicht" minOccurs="0">
  <xs:annotation>
    <xs:documentation>FKH11: Aufnahmegewicht in
Gramm</xs:documentation>
  </xs:annotation>
  <xs:simpleType>
    <xs:restriction base="xs:int">
      <xs:minInclusive value="0"/>
      <xs:maxInclusive value="99999"/>
    </xs:restriction>
  </xs:simpleType>
</xs:element>
<xs:element name="Behandlungsart"
type="kh:Behandlungsart" minOccurs="0">
  <xs:annotation>
    <xs:documentation>FKH14:
Behandlungsart</xs:documentation>
  </xs:annotation>
  </xs:element>
</xs:sequence>
</xs:complexType>
</xs:element>
<xs:element name="Verlaengerungen" minOccurs="0"
maxOccurs="99">
  <xs:annotation>
    <xs:documentation>VKH-Sätze</xs:documentation>
  </xs:annotation>
  <xs:complexType>
    <xs:attribute name="aufnahme" type="md:Datum_Stp"
use="required">
      <xs:annotation>
        <xs:documentation>VKH01: Datum der Aufnahme in
Fachabteilung im Format (JJJJ-MM-TT)</xs:documentation>
      </xs:annotation>
      </xs:attribute>
      <xs:attribute name="entlassung" type="md:Datum_Stp"
use="required">
        <xs:annotation>
          <xs:documentation>VKH02: Voraussichtliches
Entlassungsdatum im Format (JJJJ-MM-TT)</xs:documentation>
        </xs:annotation>
        </xs:attribute>
      </xs:complexType>
    </xs:element>
  <xs:element name="Diagnosen">

```

```

<xs: annotation>
  <xs: documentati on>DIA-Satz und FKH12</xs: documentati on>
</xs: annotation>
<xs: compl exType>
  <xs: sequence>
    <xs: el ement name="Di agnose" maxOccurs="999">
      <xs: annotati on>
        <xs: documentati on>DIA-Sätze </xs: documentati on>
      </xs: annotati on>
    <xs: compl exType>
      <xs: attri bute name="di agnosetyp"
type="kh: Di agnosetyp" use="requi red">
        <xs: annotati on>
          <xs: documentati on>DIA01:
Di agnosetyp</xs: documentati on>
        </xs: annotati on>
      </xs: attri bute>
    <xs: attri bute name="i cd" use="requi red">
      <xs: annotati on>
        <xs: documentati on>DIA02:
I CD-Schl üssel </xs: documentati on>
      </xs: annotati on>
    <xs: si mpl eType>
      <xs: restri cti on base="md: I CD_Schl uessel _Stp">
        <xs: mi nLength val ue="3"/>
      </xs: restri cti on>
    </xs: si mpl eType>
  </xs: attri bute>
  <xs: attri bute name="l okal i sati on"
type="md: Lokal i sati on_Stp" use="opti onal ">
    <xs: annotati on>
      <xs: documentati on>DIA03:
Lokal i sati on</xs: documentati on>
    </xs: annotati on>
  </xs: attri bute>
  <xs: attri bute name="kz_pruefung" use="opti onal ">
    <xs: annotati on>
      <xs: documentati on>DIA04: Kennzei chen -
Gesonderte Prüfung durch MD gewünscht</xs: documentati on>
    </xs: annotati on>
  <xs: si mpl eType>
    <xs: restri cti on base="xs: stri ng">
      <xs: l ength val ue="1"/>
      <xs: enumerati on val ue="1"/>
    </xs: restri cti on>
  </xs: si mpl eType>
</xs: attri bute>
</xs: compl exType>
</xs: el ement>
</xs: sequence>
<xs: attri bute name="i cd_versi on" use="requi red">
  <xs: annotati on>
    <xs: documentati on>FKH12:
I CD-Versi on</xs: documentati on>
  </xs: annotati on>

```

```

        <xs: simpleType>
          <xs: restriction base="xs:gYear">
            <xs: minOccurs value="2003"/>
            <xs: maxInclusive value="2099"/>
          </xs: restriction>
        </xs: simpleType>
      </xs: attribute>
    </xs: complexType>
  </xs: element>
  <xs: element name="Prozeduren" minOccurs="0">
    <xs: annotation>
      <xs: documentation>OPS-Satz und FKH13</xs: documentation>
    </xs: annotation>
    <xs: complexType>
      <xs: sequence>
        <xs: element name="Prozedur" minOccurs="0"
maxOccurs="999">
          <xs: annotation>
            <xs: documentation>OPS Datensätze
          </xs: annotation>
          <xs: complexType>
            <xs: attribute name="ops" use="required">
              <xs: annotation>
                <xs: documentation>OPS01:
OPS-Schlüssel </xs: documentation>
              </xs: annotation>
              <xs: simpleType>
                <xs: restriction base="kh:OPS_Schlüssel">
                  <xs: minLength value="1"/>
                </xs: restriction>
              </xs: simpleType>
            </xs: attribute>
            <xs: attribute name="Lokalisation"
type="md:Lokalisation_Stp" use="optional">
              <xs: annotation>
                <xs: documentation>OPS02:
Lokalisation </xs: documentation>
              </xs: annotation>
            </xs: attribute>
            <xs: attribute name="datum" type="md:Datum_Stp"
use="optional">
              <xs: annotation>
                <xs: documentation>OPS03: Datum OPS im Format
(JJJJ-MM-TT) </xs: documentation>
              </xs: annotation>
            </xs: attribute>
            <xs: attribute name="kz_pruefung" use="optional">
              <xs: annotation>
                <xs: documentation>OPS04: Kennzeichen -
Gesonderte Prüfung durch MD gewünscht </xs: documentation>
              </xs: annotation>
            </xs: simpleType>
            <xs: restriction base="xs:string">
              <xs: length value="1"/>
            </xs: restriction>
          </xs: complexType>
        </xs: sequence>
      </xs: complexType>
    </xs: element>
  </xs: element>

```

```

        <xs:enumeration value="1"/>
      </xs:restriction>
    </xs:simpleType>
  </xs:attribute>
</xs:complexType>
</xs:element>
</xs:sequence>
<xs:attribute name="ops_version" use="required">
  <xs:annotation>
    <xs:documentation>FKH13:
OPS-Version</xs:documentation>
  </xs:annotation>
  <xs:simpleType>
    <xs:restriction base="xs:gYear">
      <xs:minInclusive value="2003"/>
      <xs:maxInclusive value="2099"/>
    </xs:restriction>
  </xs:simpleType>
  </xs:attribute>
</xs:complexType>
</xs:element>
<xs:element name="Entlassung" minOccurs="0">
  <xs:annotation>
    <xs:documentation>EKH-Satz</xs:documentation>
  </xs:annotation>
  <xs:complexType>
    <xs:sequence>
      <xs:element name="Entgeltart" type="kh:Entgeltart"
minOccurs="0">
        <xs:annotation>
          <xs:documentation>EKH06:
Entgeltart</xs:documentation>
        </xs:annotation>
        </xs:element>
      <xs:element name="Beatmungsstunden" minOccurs="0">
        <xs:annotation>
          <xs:documentation>EKH11: Anzahl
Beatmungsstunden</xs:documentation>
        </xs:annotation>
        <xs:simpleType>
          <xs:restriction base="xs:int">
            <xs:minInclusive value="0"/>
            <xs:maxInclusive value="9999"/>
          </xs:restriction>
        </xs:simpleType>
        </xs:element>
      <xs:element name="Entbindung" type="md:Datum_Stp"
minOccurs="0" maxOccurs="2">
        <xs:annotation>
          <xs:documentation>EKH12-13: Tag der Entbindung im
Format (JJJJ-MM-TT)</xs:documentation>
        </xs:annotation>
        </xs:element>
      <xs:element name="TOB" type="kh:Anzahl_Tage3"
minOccurs="0">

```

```

</xs: element>
</xs: choice>
<xs: sequence>
  <xs: element name="KH_DRG" minOccurs="0">
    <xs: annotation>
      <xs: documentation>EKH14: Tage ohne Berechnung
    </xs: annotation>
  </xs: element>
  <xs: element name="EKH09">
    <xs: annotation>
      <xs: documentation>EKH09: Eff.
    </xs: annotation>
  </xs: element>
  <xs: element name="KH_DRG" use="optional">
    <xs: annotation>
      <xs: documentation>EKH07: Abgerechnete
    </xs: annotation>
    <xs: simpleType>
      <xs: restriction base="kh: DRG" />
    </xs: simpleType>
    <xs: attribute name="relativgewicht"
      use="optional">
      <xs: annotation>
        <xs: documentation>EKH09: Eff.
      </xs: annotation>
      <xs: simpleType>
        <xs: restriction base="xs: decimal">
          <xs: totalDigits value="8" />
          <xs: fractionDigits value="3" />
          <xs: maxExclusive value="100000" />
        </xs: restriction>
      </xs: simpleType>
    </xs: attribute>
  </xs: element>
  <xs: element name="GKV_DRG" type="kh: DRG"
    minOccurs="0">
    <xs: annotation>
      <xs: documentation>EKH08:
    </xs: annotation>
  </xs: element>
  <xs: element name="Basisfallwert" minOccurs="0">
    <xs: annotation>
      <xs: documentation>EKH10:
    </xs: annotation>
  </xs: element>
  <xs: element name="Basisfallwert">
    <xs: simpleType>
      <xs: restriction base="xs: decimal">
        <xs: totalDigits value="7" />
        <xs: fractionDigits value="2" />
        <xs: maxExclusive value="100000" />
      </xs: restriction>
    </xs: simpleType>
  </xs: element>
</xs: sequence>
</xs: choice>
</xs: element>
</xs: annotation>
</xs: documentation>
(TOB)</xs: documentation>

```

```

        </xs: restricti on>
        </xs: si mpl eType>
        </xs: el ement>
    </xs: sequence>
    <xs: sequence>
        <xs: el ement name="Abgerechnete_KH_PEPP"
            <xs: annotati on>
                <xs: documentati on>EKH15: Abgerechnete
            </xs: annotati on>
            <xs: si mpl eType>
                <xs: restricti on base="xs: string">
                    <xs: maxLength val ue="5"/>
                    <xs: mi nLength val ue="1"/>
                </xs: restricti on>
            </xs: si mpl eType>
        </xs: el ement>
        <xs: el ement name="GKV_PEPP" mi nOccurs="0">
            <xs: annotati on>
                <xs: documentati on>EKH16:
            </xs: annotati on>
            <xs: si mpl eType>
                <xs: restricti on base="xs: string">
                    <xs: maxLength val ue="5"/>
                    <xs: mi nLength val ue="1"/>
                </xs: restricti on>
            </xs: si mpl eType>
        </xs: el ement>
        <xs: el ement name="Bewertungsrel ati on"
            <xs: annotati on>
                <xs: documentati on>EKH17: Eff.
            </xs: annotati on>
            <xs: si mpl eType>
                <xs: restricti on base="xs: deci mal ">
                    <xs: total Di gi ts val ue="8"/>
                    <xs: fracti onDi gi ts val ue="4"/>
                    <xs: maxExcl usi ve val ue="10000"/>
                </xs: restricti on>
            </xs: si mpl eType>
        </xs: el ement>
        <xs: el ement name="Basi sentgel twert" mi nOccurs="0">
            <xs: annotati on>
                <xs: documentati on>EKH18: Basi sentgel twert am
            </xs: annotati on>
            <xs: si mpl eType>
                <xs: restricti on base="xs: deci mal ">
                    <xs: total Di gi ts val ue="7"/>
                    <xs: fracti onDi gi ts val ue="2"/>
                    <xs: maxExcl usi ve val ue="100000"/>
                </xs: restricti on>
        </xs: el ement>
    </xs: sequence>
</xs: documentati on>

```

mi nOccurs="0">

KH-PEPP</xs: documentati on>

GKV-PEPP</xs: documentati on>

mi nOccurs="0">

Bewertungsrel ati on der KH-PEPP</xs: documentati on>

Aufnahmetag</xs: documentati on>

```

        </xs: simpleType>
    </xs: element>
    <xs: element name="Basisentgeltwert_Entlass"
minOccurs="0">
        <xs: annotation>
            <xs: documentation>EKH19: Basisentgeltwert am
Entlassungstag</xs: documentation>
        </xs: annotation>
        <xs: simpleType>
            <xs: restriction base="xs:decimal">
                <xs: totalDigits value="7"/>
                <xs: fractionDigits value="2"/>
                <xs: maxValue="100000"/>
            </xs: restriction>
        </xs: simpleType>
    </xs: element>
    <xs: element name="Basisentgeltwert_Entlassgueltig"
type="md: Datum_Stp" minOccurs="0">
        <xs: annotation>
            <xs: documentation>EKH20: Basisentgeltwert am
Entlassungstag gültig ab</xs: documentation>
        </xs: annotation>
    </xs: element>
</xs: sequence>
</xs: choice>
</xs: sequence>
<xs: attribute name="entlassungsdatum" type="md: Datum_Stp"
use="required">
        <xs: annotation>
            <xs: documentation>EKH01: Datum Krankenhaus Entlassung
im Format (JJJJ-MM-TT)</xs: documentation>
        </xs: annotation>
    </xs: attribute>
<xs: attribute name="entlassungszeit" type="xs: time"
use="required">
        <xs: annotation>
            <xs: documentation>EKH02: Uhrzeit Krankenhaus
Entlassung im Format (HH:MM:SS)</xs: documentation>
        </xs: annotation>
    </xs: attribute>
<xs: attribute name="fachabteilung"
type="kh: Fachabteilung" use="required">
        <xs: annotation>
            <xs: documentation>EKH03: Fachabteilungs- schlüssel der
entlassenden Abteilung</xs: documentation>
        </xs: annotation>
    </xs: attribute>
<xs: attribute name="abteilungstyp"
type="md: Abteilungstyp_Stp" use="optional">
        <xs: annotation>
            <xs: documentation>EKH04: Zusatzschlüssel
Abteilungstyp</xs: documentation>
        </xs: annotation>
    </xs: attribute>
<xs: attribute name="entlassungsgrund"

```

```

type="kh: Entlassungsgrund" use="required">
  <xs: annotation>
    <xs: documentation>EKH05: Grund der
Entlassung/Verlegung</xs: documentation>
  </xs: annotation>
</xs: attribute>
</xs: complexType>
</xs: element>
<xs: element name="Verlegungen" minOccurs="0" maxOccurs="999">
  <xs: annotation>
    <xs: documentation>LKH-Sätze </xs: documentation>
  </xs: annotation>
  <xs: complexType>
    <xs: attribute name="von" type="md: Datum_Stp"
use="optional">
      <xs: annotation>
        <xs: documentation>LKH01: Datum Behandlung von im
Format (JJJJ-MM-TT)</xs: documentation>
      </xs: annotation>
      </xs: attribute>
      <xs: attribute name="bis" type="md: Datum_Stp"
use="required">
        <xs: annotation>
          <xs: documentation>LKH02: Datum Behandlung
bis/Verlegung am im Format (JJJJ-MM-TT)</xs: documentation>
        </xs: annotation>
        </xs: attribute>
        <xs: attribute name="fachabteilung"
type="kh: Fachabteilung" use="required">
          <xs: annotation>
            <xs: documentation>LKH03:
Fachabteilung</xs: documentation>
          </xs: annotation>
          </xs: attribute>
          <xs: attribute name="verlegungsgrund"
type="kh: Entlassungsgrund" use="required">
            <xs: annotation>
              <xs: documentation>LKH04: Entlassungs/
Verlegungsgrund</xs: documentation>
            </xs: annotation>
            </xs: attribute>
            <xs: attribute name="uhrzeit" type="xs: time"
use="required">
              <xs: annotation>
                <xs: documentation>LKH05:
Entlassungs-/Verlegungsuhrzeit im Format (HH: MM: SS)</xs: documentation>
              </xs: annotation>
              </xs: attribute>
            </xs: complexType>
          </xs: element>
          <xs: element name="Entgelte" minOccurs="0" maxOccurs="999">
            <xs: annotation>
              <xs: documentation>ETG-Sätze </xs: documentation>
            </xs: annotation>
            <xs: complexType>

```

```

<xs:attribute name="entgeltart" use="required">
  <xs:annotation>
    <xs:documentation>ETG01:
Entgeltart</xs:documentation>
  </xs:annotation>
  <xs:simpleType>
    <xs:restriction base="kh:Entgeltart">
      <xs:length value="8"/>
    </xs:restriction>
  </xs:simpleType>
</xs:attribute>
<xs:attribute name="bezeichnung" use="required">
  <xs:annotation>
    <xs:documentation>ETG02: Bezeichnung des Entgelts
</xs:documentation>
  </xs:annotation>
  <xs:simpleType>
    <xs:restriction base="kh:Bezeichnung_Entgelt"/>
  </xs:simpleType>
</xs:attribute>
<xs:attribute name="betrag" use="optional">
  <xs:annotation>
    <xs:documentation>ETG03: Entgeltbetrag
</xs:documentation>
  </xs:annotation>
  <xs:simpleType>
    <xs:restriction base="xs:decimal">
      <xs:fractionDigits value="2" fixed="false"/>
      <xs:totalDigits value="9"/>
      <xs:maxExclusive value="100000000"/>
    </xs:restriction>
  </xs:simpleType>
</xs:attribute>
<xs:attribute name="abrechnung_von" type="md:Datum_Stp"
use="optional">
  <xs:annotation>
    <xs:documentation>ETG04: Entgelt Abrechnung von im
Format(JJJJ-MM-TT)</xs:documentation>
  </xs:annotation>
  </xs:attribute>
<xs:attribute name="abrechnung_bis" type="md:Datum_Stp"
use="optional">
  <xs:annotation>
    <xs:documentation>ETG05: Entgelt Abrechnung bis im
Format(JJJJ-MM-TT)</xs:documentation>
  </xs:annotation>
  </xs:attribute>
<xs:attribute name="entgelt_anzahl"
type="kh:Anzahl_Tage3" use="required">
  <xs:annotation>
    <xs:documentation>ETG06: Anzahl des
Entgeltschlüssels</xs:documentation>
  </xs:annotation>
  </xs:attribute>
<xs:attribute name="TOB" type="kh:Anzahl_Tage3"

```

```

use="optional">
    <xs:annotation>
    <xs:documentation>ETG07: Tage ohne
Berechnung/Behandlung</xs:documentation>
    </xs:annotation>
</xs:attribute>
<xs:attribute name="kz_pruefung" use="optional">
    <xs:annotation>
    <xs:documentation>ETG08: Kennzeichen - Gesonderte
Prüfung durch MD gewünscht</xs:documentation>
    </xs:annotation>
    <xs:simpleType>
    <xs:restriction base="xs:string">
    <xs:length value="1"/>
    <xs:enumeration value="1"/>
    </xs:restriction>
    </xs:simpleType>
</xs:attribute>
</xs:complexType>
</xs:element>
<xs:element name="Aktenzeichen_anderer_Begutachtungsfall"
type="md:Aktenzeichen_anderer_Begutachtungsfall_Ctp" minOccurs="0" maxOccurs="9">
    <xs:annotation>
    <xs:documentation>AAB: Aktenzeichen anderer
Begutachtungsfall</xs:documentation>
    </xs:annotation>
</xs:element>
<xs:element name="Standorte" minOccurs="0" maxOccurs="99">
    <xs:annotation>
    <xs:documentation>STA-Sätze</xs:documentation>
    </xs:annotation>
    <xs:complexType>
    <xs:attribute name="standortnummer" use="required">
    <xs:annotation>
    <xs:documentation>STA01:
Standortnummer</xs:documentation>
    </xs:annotation>
    <xs:simpleType>
    <xs:restriction base="xs:string">
    <xs:length value="9"/>
    </xs:restriction>
    </xs:simpleType>
</xs:attribute>
<xs:attribute name="ende_datum" type="md:Datum_Stp"
use="required">
    <xs:annotation>
    <xs:documentation>STA02: Standort Ende im Format
(JJJJ-MM-TT)</xs:documentation>
    </xs:annotation>
</xs:attribute>
<xs:attribute name="ende_uhrzeit" type="xs:time"
use="required">
    <xs:annotation>
    <xs:documentation>STA03: Standort Ende Uhrzeit im
Format (HH:MM:SS)</xs:documentation>

```

```

        </xs: annotation>
        </xs: attribute>
        </xs: complexType>
        </xs: element>
        </xs: sequence>
        </xs: complexType>
        </xs: element>
        </xs: sequence>
        <xs: attribute name="geltungsbereich" type="kh: Abrechnungsart"
use="required">
        <xs: annotation>
        <xs: documentation>AKH01: Gesetzlicher Geltungsbereich der
Abrechnung</xs: documentation>
        </xs: annotation>
        </xs: attribute>
        <xs: attribute name="fall_ID" use="required">
        <xs: annotation>
        <xs: documentation>AKH02: Fall-ID KH
(Aufnahmenummer)</xs: documentation>
        </xs: annotation>
        <xs: simpleType>
        <xs: restriction base="kh: Fall_ID">
        <xs: minLength value="1"/>
        </xs: restriction>
        </xs: simpleType>
        </xs: attribute>
        <xs: attribute name="rechnungsnummer" type="kh: Rechnungsnummer"
use="optional">
        <xs: annotation>
        <xs: documentation>AKH03: Rechnungsnummer</xs: documentation>
        </xs: annotation>
        </xs: attribute>
        <xs: attribute name="rechnungsdatum" type="md: Datum_Stp"
use="optional">
        <xs: annotation>
        <xs: documentation>AKH04: Rechnungsdatum im Format
(JJJJ-MM-TT)</xs: documentation>
        </xs: annotation>
        </xs: attribute>
        <xs: attribute name="rechnungseingang" type="md: Datum_Stp"
use="optional">
        <xs: annotation>
        <xs: documentation>AKH05: Datum des Rechnungseingang im Format
(JJJJ-MM-TT)</xs: documentation>
        </xs: annotation>
        </xs: attribute>
        <xs: attribute name="auftragsart" type="kh: Auftragsart"
use="required">
        <xs: annotation>
        <xs: documentation>AKH06: Auftragsart</xs: documentation>
        </xs: annotation>
        </xs: attribute>
        <xs: attribute name="anlagen_PDF" use="required">
        <xs: annotation>
        <xs: documentation>AKH07: Anzahl der Anlagen</xs: documentation>

```

```

</xs: annotation>
<xs: simpleType>
  <xs: restriction base="xs:string">
    <xs:length value="1"/>
    <xs:pattern value="[0-9]"/>
  </xs:restriction>
</xs:simpleType>
</xs:attribute>
<xs:attribute name="anlagen_post" use="required">
  <xs:annotation>
    <xs:documentation>AKH08: Anzahl der Anlagen per
Postweg</xs:documentation>
  </xs:annotation>
</xs:simpleType>
  <xs:restriction base="xs:string">
    <xs:length value="1"/>
    <xs:pattern value="[0-9]"/>
  </xs:restriction>
</xs:simpleType>
</xs:attribute>
<xs:attribute name="anlagen_post_text"
type="md:Freitext_Mitzeichen_Stp" use="optional">
  <xs:annotation>
    <xs:documentation>AKH09: Erläuterung Anlagen per
Postweg</xs:documentation>
  </xs:annotation>
</xs:attribute>
<xs:attribute name="unterlagen_beiMD" use="optional">
  <xs:annotation>
    <xs:documentation>AKH10: Unterlagen liegen bereits beim MD
vor</xs:documentation>
  </xs:annotation>
</xs:simpleType>
  <xs:restriction base="xs:string">
    <xs:length value="1"/>
    <xs:enumeration value="1"/>
  </xs:restriction>
</xs:simpleType>
</xs:attribute>
<xs:attribute name="unterlagen_beiMD_text"
type="md:Freitext_Mitzeichen_Stp" use="optional">
  <xs:annotation>
    <xs:documentation>AKH11: Erläuterung Unterlagen, die bereits beim
MD vorliegen</xs:documentation>
  </xs:annotation>
</xs:attribute>
<xs:attribute name="vorverfahren_ergebnis" type="kh:Vorverf_Ergebnis"
use="optional">
  <xs:annotation>
    <xs:documentation>AKH12: Ergebnis Vorverfahren</xs:documentation>
  </xs:annotation>
</xs:attribute>
<xs:attribute name="ber_erw_fragestellung"
type="kh:Ber_Erw_Fragestellung" use="required">
  <xs:annotation>

```

```

        <xs:documentati on>AKH13: Berechtigung des MD zur Ergänzung der
Fragestellung</xs:documentati on>
        </xs:annotati on>
        </xs:attri bute>
        <xs:attri bute name="wechsel_auftragsart"
type="kh: Wechsel_Auftragsart" use="requi red">
        <xs:annotati on>
        <xs:documentati on>AKH14: Berechtigung des MD zum Wechsel der
Auftragsart</xs:documentati on>
        </xs:annotati on>
        </xs:attri bute>
        <xs:attri bute name="ber_erw_pruefgegenstand"
type="kh: Berechtigung_Erwei terung_Pruefgegenstand" use="requi red">
        <xs:annotati on>
        <xs:documentati on>AKH15: Berechtigung des MD zur Erwei terung des
Prüfgegenstandes</xs:documentati on>
        </xs:annotati on>
        </xs:attri bute>
        </xs:compl exType>
</xs:el ement>
<xs:el ement name="Storno">
        <xs:annotati on>
        <xs:documentati on>Stornierungsmel dung an MD</xs:documentati on>
        </xs:annotati on>
        <xs:compl exType>
        <xs:attri bute name="auftragsart" type="kh: Auftragsart"
use="requi red">
        <xs:annotati on>
        <xs:documentati on>AST01: Auftragsart</xs:documentati on>
        </xs:annotati on>
        </xs:attri bute>
        <xs:attri bute name="aktenzei chen" type="md: Aktenzei chen_Stp"
use="requi red">
        <xs:annotati on>
        <xs:documentati on>AST02: Aktenzei chen der
Krankenkasse</xs:documentati on>
        </xs:annotati on>
        </xs:attri bute>
        <xs:attri bute name="erl aeuterung" type="kh: Frei text_1024"
use="opti onal ">
        <xs:annotati on>
        <xs:documentati on>AST03: Erl äuterungen</xs:documentati on>
        </xs:annotati on>
        </xs:attri bute>
        </xs:compl exType>
</xs:el ement>
<xs:el ement name="Zwi schennachri cht_ZAP">
        <xs:annotati on>
        <xs:documentati on>Zwi schennachri cht Antwort Erwei terung des
Prüfgegenstandes (ZAP) an MD</xs:documentati on>
        </xs:annotati on>
        <xs:compl exType>
        <xs:sequence>
        <xs:el ement name="AZ_KK" mi n0ccurs="1">
        <xs:annotati on>

```

```

        <xs:documentati on>ZAP01: Aktenzei chen der
Krankenkasse</xs:documentati on>
        </xs:annotati on>
        <xs:simpl eType>
        <xs:restr icti on base="xs:stri ng">
        <xs:minLength val ue="2"/>
        <xs:maxLength val ue="18"/>
        </xs:restr icti on>
        </xs:simpl eType>
        </xs:el ement>
        <xs:el ement name="Datum_Antwort" type="md: Datum_Stp" mi nOccurs="1">
        <xs:annotati on>
        <xs:documentati on>ZAP02: Datum der Antwort der Krankenkasse zur
Erwei terung des Prüfgegenstandes</xs:documentati on>
        </xs:annotati on>
        </xs:el ement>
        <xs:el ement name="Antwort_Erwei terung_Pruefgegenstand"
type="kh: Berechtigung_Erwei terung_Pruefgegenstand" mi nOccurs="1">
        <xs:annotati on>
        <xs:documentati on>ZAP03: Antwort Erwei terung Prüfgegenstand
(Schl üssel T)</xs:documentati on>
        </xs:annotati on>
        </xs:el ement>
        </xs:sequence>
        </xs:compl exType>
        </xs:el ement>
        </xs:choi ce>
        <xs:el ement name="Dokument" type="md: Dokument_Ctp" mi nOccurs="0"
maxOccurs="9">
        <xs:annotati on>
        <xs:documentati on>DOK: Stammdaten Dokument</xs:documentati on>
        </xs:annotati on>
        </xs:el ement>
        </xs:sequence>
        <xs:attri buteGroup ref="md: vkz_Grp"/>
        <xs:attri bute name="verfahrenskennzei chen"
type="kh: Verfahrenskennzei chen_Stp" use="requi red">
        <xs:annotati on>
        <xs:documentati on>VKZ06: Verfahrenskennzei chen</xs:documentati on>
        </xs:annotati on>
        </xs:attri bute>
        <xs:attri bute name="ta_versi on" type="kh: Schl uessel _V_Stp" use="requi red">
        <xs:annotati on>
        <xs:documentati on>VKZ07: TA Versi on</xs:documentati on>
        </xs:annotati on>
        </xs:attri bute>
        </xs:compl exType>
</xs:el ement>

```

attribute Beauftragung/@verfahrenskennzeichen

type	Verfahrenskennzeichen Stp
properties	use required

facets	<table border="1"> <thead> <tr> <th>Kind</th> <th>Value</th> <th>Annotation</th> </tr> </thead> <tbody> <tr> <td>enumeration</td> <td>EMDK0</td> <td></td> </tr> <tr> <td>enumeration</td> <td>TMDK0</td> <td></td> </tr> </tbody> </table>	Kind	Value	Annotation	enumeration	EMDK0		enumeration	TMDK0	
Kind	Value	Annotation								
enumeration	EMDK0									
enumeration	TMDK0									
annotation	documentation VKZ06: Verfahrenskennzeichen									
source	<pre><xs:attribute name="verfahrenskennzeichen" type="kh:Verfahrenskennzeichen_Stp" use="required"> <xs:annotation> <xs:documentation>VKZ06: Verfahrenskennzeichen</xs:documentation> </xs:annotation> </xs:attribute></pre>									

attribute Beauftragung/@ta_version

type	Schluessel_V_Stp									
properties	use required									
facets	<table border="1"> <thead> <tr> <th>Kind</th> <th>Value</th> <th>Annotation</th> </tr> </thead> <tbody> <tr> <td>pattern</td> <td>[1-9][0-9]?\.?[1-9]?[0-9]</td> <td></td> </tr> <tr> <td>enumeration</td> <td>1.11</td> <td></td> </tr> </tbody> </table>	Kind	Value	Annotation	pattern	[1-9][0-9]?\.?[1-9]?[0-9]		enumeration	1.11	
Kind	Value	Annotation								
pattern	[1-9][0-9]?\.?[1-9]?[0-9]									
enumeration	1.11									
annotation	documentation VKZ07: TA Version									
source	<pre><xs:attribute name="ta_version" type="kh:Schluessel_V_Stp" use="required"> <xs:annotation> <xs:documentation>VKZ07: TA Version</xs:documentation> </xs:annotation> </xs:attribute></pre>									

element Beauftragung/Krankenkasse

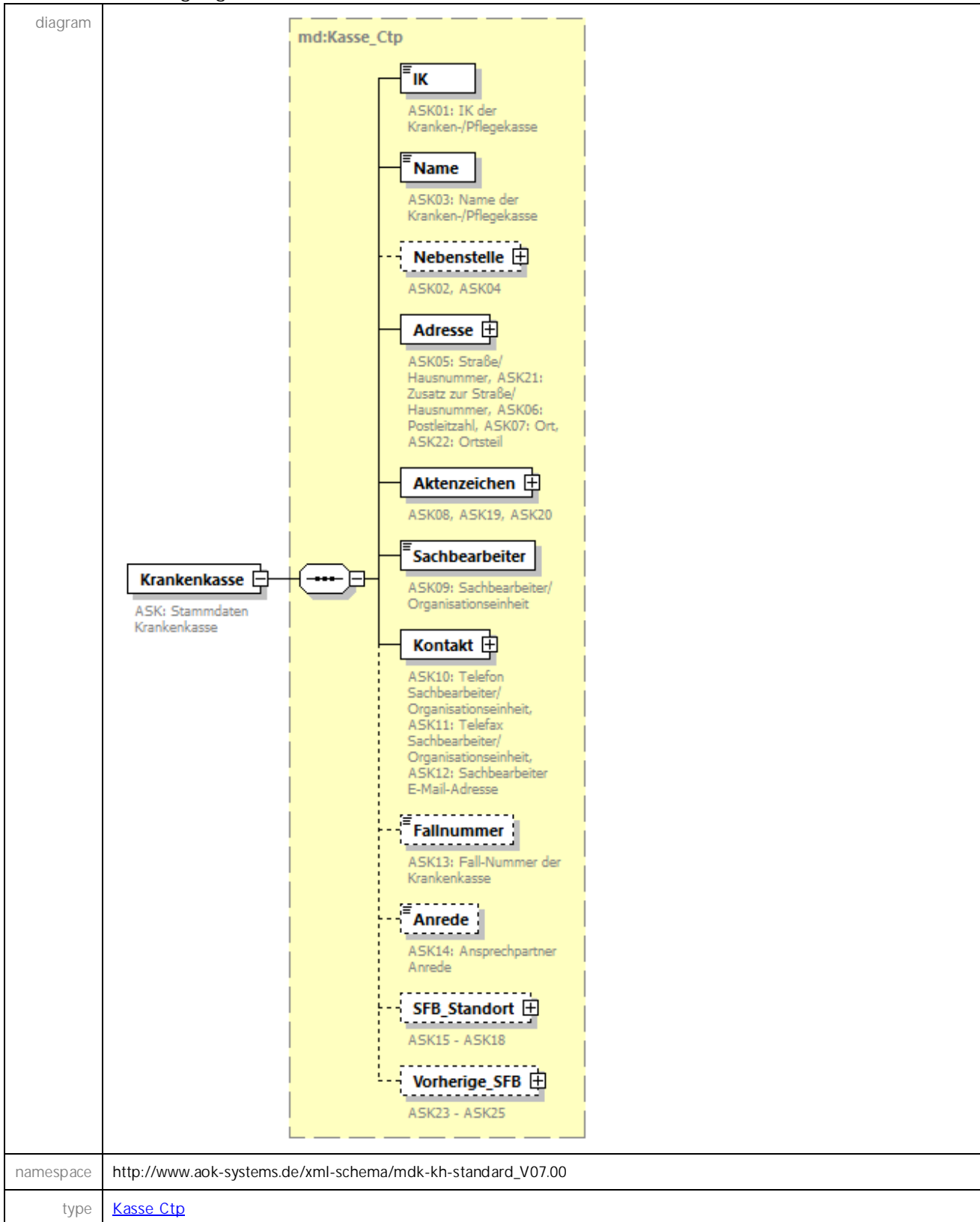

properties	content complex
children	IK Name Nebestelle Adresse Aktenzeichen Sachbearbeiter Kontakt Fallnummer Anrede SFB Standort Vorherige SFB
annotation	documentation ASK: Stammdaten Krankenkasse
source	<pre><xs:element name="Krankenkasse" type="md:Kasse_Ctp"> <xs:annotation> <xs:documentation>ASK: Stammdaten Krankenkasse</xs:documentation> </xs:annotation> </xs:element></pre>

element Beauftragung/Versicherter

diagram	
namespace	http://www.aok-systems.de/xml-schema/mdk-kh-standard_V07.00
type	Versicherter_Ctp
properties	content complex

children	KV PV Nummer Person Adresse Kontakt
annotation	documentation ASV: Stammdaten Versicherter
source	<pre><xs:element name="Versicherter" type="md:Versicherter_Ctp"> <xs:annotation> <xs:documentation>ASV: Stammdaten Versicherter</xs:documentation> </xs:annotation> </xs:element></pre>

element Beauftragung/Auftrag

diagram

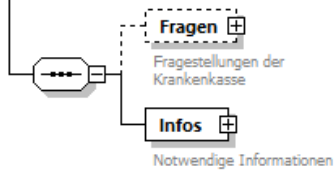

namespace	http://www.aok-systems.de/xml-schema/mdk-kh-standard_V07.00					
properties	content complex					
children	Fragen Infos					
attributes	Name	Type	Use	Default	Fixed	Annotation
	geltungsbereich	Abrechnungsart	required			documentation AKH01: Gesetzlicher Geltungsbereich der Abrechnung
	fall_ID	derived by: Fall_ID	required			documentation AKH02: Fall-ID KH (Aufnahmenummer)
	rechnungsnummer	Rechnungsnummer	optional			documentation AKH03: Rechnungsnummer
	rechnungsdatum	Datum_Stp	optional			documentation AKH04: Rechnungsdatum im Format (JJJJ-MM-TT)
	rechnungseingang	Datum_Stp	optional			documentation AKH05: Datum des Rechnungseingangs im Format (JJJJ-MM-TT)
	auftragsart	Auftragsart	required			documentation AKH06: Auftragsart
	anlagen_PDF	derived by: xs:string	required			documentation AKH07: Anzahl der Anlagen
	anlagen_post	derived by: xs:string	required			documentation AKH08: Anzahl der Anlagen per Postweg
	anlagen_post_text	Freitext Mit Zeichen_Stp	optional			documentation AKH09: Erläuterung Anlagen per Postweg
	unterlagen_beiMD	derived by: xs:string	optional			documentation AKH10: Unterlagen liegen bereits beim MD vor
	unterlagen_beiMD_text	Freitext Mit Zeichen_Stp	optional			documentation AKH11: Erläuterung Unterlagen, die bereits beim MD vorliegen

	<p>vorverfahren_ergebnis Vorverf_Ergebnis optional documentation AKH12: Ergebnis Vorverfahren</p> <p>ber_erw_fragestellung Ber_Erw_Fragestellung required documentation AKH13: Berechtigung des MD zur Ergänzung der Fragestellung</p> <p>wechsel_auftragsart Wechsel_Auftragsart required documentation AKH14: Berechtigung des MD zum Wechsel der Auftragsart</p> <p>ber_erw_pruefgegenstand Berechtigung_Erweiterung_Pruefgegenstand required documentation AKH15: Berechtigung des MD zur Erweiterung des Prüfgegenstandes</p>
annotation	documentation Auftrag an MD
source	<pre> <xs:element name="Auftrag"> <xs:annotation> <xs:documentation>Auftrag an MD</xs:documentation> </xs:annotation> <xs:complexType> <xs:sequence> <xs:element name="Fragen" type="kh:CT_Fragestellung" minOccurs="0"> <xs:annotation> <xs:documentation>Fragestellungen der Krankenkasse</xs:documentation> </xs:annotation> <xs:unique name="key_frage"> <xs:selector xpath="kh:frage"/> <xs:field xpath="@frage_ID"/> </xs:unique> </xs:element> <xs:element name="Infos"> <xs:annotation> <xs:documentation>Notwendige Informationen</xs:documentation> </xs:annotation> <xs:complexType> <xs:sequence> <xs:element name="Leistungserbringer" type="md:Leistungserbringer_Ctp"> <xs:annotation> <xs:documentation>SDL: Stammdaten Leistungserbringer</xs:documentation> </xs:annotation> </xs:element> <xs:element name="Pruefgegenstaende" type="kh:CT_Pruefgegenstand" minOccurs="0"> <xs:annotation> <xs:documentation>PGS-Sätze: Prüfgegenstand</xs:documentation> </xs:annotation> <xs:unique name="key_pruefgegenstand"> <xs:selector xpath="kh:Pruefgegenstand"/> </xs:unique> </xs:element> </xs:sequence> </xs:complexType> </xs:element> </xs:sequence> </xs:complexType> </xs:element> </pre>

```

        <xs:field xpath="@pruefgegenstand"/>
    </xs:unique>
</xs:element>
<xs:element name="Fall daten">
    <xs:annotation>
        <xs:documentation>FKH-Satz</xs:documentation>
    </xs:annotation>
    <xs:complexType>
        <xs:sequence>
            <xs:element name="Aufnahme">
                <xs:annotation>
                    <xs:documentation>FKH01-05</xs:documentation>
                </xs:annotation>
                <xs:complexType>
                    <xs:attribute name="tag" type="md: Datum_Stp" use="required">
                        <xs:annotation>
                            <xs:documentation>FKH01: Datum Krankenhaus-Aufnahme im
Format (JJJJ-MM-TT)</xs:documentation>
                        </xs:annotation>
                    </xs:attribute>
                    <xs:attribute name="uhrzeit" type="xs:time" use="required">
                        <xs:annotation>
                            <xs:documentation>FKH02: Uhrzeit Krankenhaus-Aufnahme im
Format (HH:MM:SS)</xs:documentation>
                        </xs:annotation>
                    </xs:attribute>
                    <xs:attribute name="aufnahmegrund" use="required">
                        <xs:annotation>
                            <xs:documentation>FKH03: Aufnahmegrund
</xs:documentation>
                        </xs:annotation>
                    </xs:attribute>
                    <xs:restriction base="kh: Aufnahmegrund"/>
                </xs:complexType>
                <xs:attribute name="aufnahmeanlass" type="kh: Aufnahmeanlass"
use="required">
                    <xs:annotation>
                        <xs:documentation>FKH04: Aufnahmeanlass
</xs:documentation>
                    </xs:annotation>
                </xs:attribute>
                <xs:attribute name="fachabteilung" type="kh: Fachabteilung"
use="required">
                    <xs:annotation>
                        <xs:documentation>FKH05:
Fachabteilung</xs:documentation>
                    </xs:annotation>
                </xs:attribute>
            </xs:sequence>
        </xs:complexType>
    </xs:element>
    <xs:element name="Entlassung" type="md: Datum_Stp" minOccurs="0">
        <xs:annotation>
            <xs:documentation>FKH06: Voraussichtliches Entlassungsdatum
im Format (JJJJ-MM-TT)</xs:documentation>
        </xs:annotation>
    </xs:element>

```

```

        </xs: annotation>
    </xs: element>
    <xs: element name="Arztnummer" minOccurs="0">
        <xs: annotation>
            <xs: documentation>FKH07: Arzt-Nummer des einweisenden
Arztes</xs: documentation>
        </xs: annotation>
        <xs: simpleType>
            <xs: restriction base="kh: Arztnummer" />
        </xs: simpleType>
    </xs: element>
    <xs: element name="IK_Stelle" type="kh: IK_Stelle" minOccurs="0">
        <xs: annotation>
            <xs: documentation>FKH08: IK der veranlassenden
Stelle</xs: documentation>
        </xs: annotation>
    </xs: element>
    <xs: element name="Stelle_Notfall" type="kh: Name_Stelle_Notfall"
minOccurs="0">
        <xs: annotation>
            <xs: documentation>FKH09: Veranlassende Stelle bei
Notfallaufnahme</xs: documentation>
        </xs: annotation>
    </xs: element>
    <xs: element name="Zahnarztnummer" minOccurs="0">
        <xs: annotation>
            <xs: documentation>FKH10: Arzt-Nummer des einweisenden
Zahnarztes</xs: documentation>
        </xs: annotation>
        <xs: simpleType>
            <xs: restriction base="kh: Arztnummer" />
        </xs: simpleType>
    </xs: element>
    <xs: element name="Gewicht" minOccurs="0">
        <xs: annotation>
            <xs: documentation>FKH11: Aufnahmegewicht in
Gramm</xs: documentation>
        </xs: annotation>
        <xs: simpleType>
            <xs: restriction base="xs: int">
                <xs: minInclusive value="0" />
                <xs: maxInclusive value="99999" />
            </xs: restriction>
        </xs: simpleType>
    </xs: element>
    <xs: element name="Behandlungsart" type="kh: Behandlungsart"
minOccurs="0">
        <xs: annotation>
            <xs: documentation>FKH14: Behandlungsart</xs: documentation>
        </xs: annotation>
    </xs: element>
</xs: sequence>
</xs: complexType>
</xs: element>
<xs: element name="Verlaengerungen" minOccurs="0" maxOccurs="99">

```

```

<xs: annotation>
  <xs: documentation>VKH-Sätze</xs: documentation>
</xs: annotation>
<xs: complexType>
  <xs: attribute name="aufnahme" type="md: Datum_Stp" use="required">
    <xs: annotation>
      <xs: documentation>VKH01: Datum der Aufnahme in Fachabteilung im
Format (JJJJ-MM-TT)</xs: documentation>
    </xs: annotation>
  </xs: attribute>
  <xs: attribute name="entlassung" type="md: Datum_Stp" use="required">
    <xs: annotation>
      <xs: documentation>VKH02: Voraussichtliches Entlassungsdatum im
Format (JJJJ-MM-TT)</xs: documentation>
    </xs: annotation>
  </xs: attribute>
</xs: complexType>
</xs: element>
<xs: element name="Diagnosen">
  <xs: annotation>
    <xs: documentation>DIA-Satz und FKH12</xs: documentation>
  </xs: annotation>
  <xs: complexType>
    <xs: sequence>
      <xs: element name="Diagnose" maxOccurs="999">
        <xs: annotation>
          <xs: documentation>DIA-Sätze </xs: documentation>
        </xs: annotation>
        <xs: complexType>
          <xs: attribute name="diagnosetyp" type="kh: Diagnosetyp"
use="required">
            <xs: annotation>
              <xs: documentation>DIA01: Diagnosentyp</xs: documentation>
            </xs: annotation>
          </xs: attribute>
          <xs: attribute name="icd" use="required">
            <xs: annotation>
              <xs: documentation>DIA02:
ICD-Schlüssel </xs: documentation>
            </xs: annotation>
          </xs: attribute>
          <xs: simpleType>
            <xs: restriction base="md: ICD_Schlüssel_Stp">
              <xs: minLength value="3"/>
            </xs: restriction>
          </xs: simpleType>
        </xs: complexType>
      </xs: attribute>
    </xs: sequence>
  </xs: element>
  <xs: attribute name="lokalisation" type="md: Lokalisation_Stp"
use="optional">
    <xs: annotation>
      <xs: documentation>DIA03: Lokalisation</xs: documentation>
    </xs: annotation>
  </xs: attribute>
  <xs: attribute name="kz_pruefung" use="optional">
    <xs: annotation>
      <xs: documentation>DIA04: Kennzeichen - Gesonderte Prüfung

```

```

durch MD gewünscht</xs:documentation>
  </xs:annotation>
  <xs:simpleType>
    <xs:restriction base="xs:string">
      <xs:length value="1"/>
      <xs:enumeration value="1"/>
    </xs:restriction>
  </xs:simpleType>
</xs:attribute>
</xs:complexType>
</xs:element>
</xs:sequence>
<xs:attribute name="icd_version" use="required">
  <xs:annotation>
    <xs:documentation>FKH12: ICD-Version</xs:documentation>
  </xs:annotation>
  <xs:simpleType>
    <xs:restriction base="xs:gYear">
      <xs:minInclusive value="2003"/>
      <xs:maxInclusive value="2099"/>
    </xs:restriction>
  </xs:simpleType>
</xs:attribute>
</xs:complexType>
</xs:element>
<xs:element name="Prozeduren" minOccurs="0">
  <xs:annotation>
    <xs:documentation>OPS-Satz und FKH13</xs:documentation>
  </xs:annotation>
  <xs:complexType>
    <xs:sequence>
      <xs:element name="Prozedur" minOccurs="0" maxOccurs="999">
        <xs:annotation>
          <xs:documentation>OPS Datensätze </xs:documentation>
        </xs:annotation>
        <xs:complexType>
          <xs:attribute name="ops" use="required">
            <xs:annotation>
              <xs:documentation>OPS01:
OPS-Schlüssel </xs:documentation>
              </xs:annotation>
              <xs:simpleType>
                <xs:restriction base="kh:OPS_Schlüssel">
                  <xs:minLength value="1"/>
                </xs:restriction>
              </xs:simpleType>
            </xs:attribute>
            <xs:attribute name="lokalisation" type="md:Lokalisation_Stp"
use="optional">
              <xs:annotation>
                <xs:documentation>OPS02: Lokalisation</xs:documentation>
              </xs:annotation>
            </xs:attribute>
            <xs:attribute name="datum" type="md:Datum_Stp"
use="optional">

```

```

        <xs: annotation>
          <xs: documentation>OPS03: Datum OPS im Format
(JJJJ-MM-TT)</xs: documentation>
        </xs: annotation>
      </xs: attribute>
      <xs: attribute name="kz_pruefung" use="optional">
        <xs: annotation>
          <xs: documentation>OPS04: Kennzeichen - Gesonderte Prüfung
durch MD gewünscht</xs: documentation>
        </xs: annotation>
        <xs: simpleType>
          <xs: restriction base="xs:string">
            <xs:length value="1"/>
            <xs:enumeration value="1"/>
          </xs: restriction>
        </xs: simpleType>
      </xs: attribute>
    </xs: complexType>
  </xs: element>
</xs: sequence>
<xs: attribute name="ops_version" use="required">
  <xs: annotation>
    <xs: documentation>FKH13: OPS-Version</xs: documentation>
  </xs: annotation>
  <xs: simpleType>
    <xs: restriction base="xs:gYear">
      <xs:minInclusive value="2003"/>
      <xs:maxInclusive value="2099"/>
    </xs: restriction>
  </xs: simpleType>
</xs: attribute>
</xs: complexType>
</xs: element>
<xs: element name="Entlassung" minOccurs="0">
  <xs: annotation>
    <xs: documentation>EKH-Satz</xs: documentation>
  </xs: annotation>
  <xs: complexType>
    <xs: sequence>
      <xs: element name="Entgeltart" type="kh:Entgeltart" minOccurs="0">
        <xs: annotation>
          <xs: documentation>EKH06: Entgeltart</xs: documentation>
        </xs: annotation>
      </xs: element>
      <xs: element name="Beatmungsstunden" minOccurs="0">
        <xs: annotation>
          <xs: documentation>EKH11: Anzahl
Beatmungsstunden</xs: documentation>
        </xs: annotation>
        <xs: simpleType>
          <xs: restriction base="xs:int">
            <xs:minInclusive value="0"/>
            <xs:maxInclusive value="9999"/>
          </xs: restriction>
        </xs: simpleType>
      </xs: element>
    </xs: sequence>
  </xs: complexType>
</xs: element>

```

```

</xs:element>
<xs:element name="Entbindung" type="md: Datum_Stp" minOccurs="0"
maxOccurs="2">
  <xs:annotation>
    <xs:documentation>EKH12-13: Tag der Entbindung im Format
(JJJJ-MM-TT)</xs:documentation>
  </xs:annotation>
</xs:element>
<xs:element name="TOB" type="kh: Anzahl_Tage3" minOccurs="0">
  <xs:annotation>
    <xs:documentation>EKH14: Tage ohne Berechnung
(TOB)</xs:documentation>
  </xs:annotation>
</xs:element>
<xs:choice>
  <xs:sequence>
    <xs:element name="KH_DRG" minOccurs="0">
      <xs:annotation>
        <xs:documentation>EKH07, EKH09</xs:documentation>
      </xs:annotation>
      <xs:complexType>
        <xs:attribute name="DRG" use="optional">
          <xs:annotation>
            <xs:documentation>EKH07: Abgerechnete
KH-DRG</xs:documentation>
          </xs:annotation>
        </xs:attribute>
        <xs:simpleType>
          <xs:restriction base="kh: DRG" />
        </xs:simpleType>
      </xs:complexType>
      <xs:attribute name="relativgewicht" use="optional">
        <xs:annotation>
          <xs:documentation>EKH09: Eff. Relativgewicht der
KH-DRG</xs:documentation>
        </xs:annotation>
      </xs:attribute>
    </xs:element>
    <xs:simpleType>
      <xs:restriction base="xs: decimal">
        <xs:totalDigits value="8" />
        <xs:fractionDigits value="3" />
        <xs:maxExclusive value="100000" />
      </xs:restriction>
    </xs:simpleType>
  </xs:sequence>
</xs:choice>
</xs:element>
<xs:element name="GKV_DRG" type="kh: DRG" minOccurs="0">
  <xs:annotation>
    <xs:documentation>EKH08: GKV-DRG</xs:documentation>
  </xs:annotation>
</xs:element>
<xs:element name="Basissfallwert" minOccurs="0">
  <xs:annotation>
    <xs:documentation>EKH10:
Basissfallwert</xs:documentation>
  </xs:annotation>

```

```

        <xs: simpleType>
          <xs: restriction base="xs: decimal">
            <xs: totalDigits value="7"/>
            <xs: fractionDigits value="2"/>
            <xs: maxExclusive value="100000"/>
          </xs: restriction>
        </xs: simpleType>
      </xs: element>
    </xs: sequence>
  <xs: sequence>
    <xs: element name="Abgerechnete_KH_PEPP" minOccurs="0">
      <xs: annotation>
        <xs: documentation>EKH15: Abgerechnete
KH-PEPP</xs: documentation>
      </xs: annotation>
      <xs: simpleType>
        <xs: restriction base="xs: string">
          <xs: maxLength value="5"/>
          <xs: minLength value="1"/>
        </xs: restriction>
      </xs: simpleType>
    </xs: element>
    <xs: element name="GKV_PEPP" minOccurs="0">
      <xs: annotation>
        <xs: documentation>EKH16: GKV-PEPP</xs: documentation>
      </xs: annotation>
      <xs: simpleType>
        <xs: restriction base="xs: string">
          <xs: maxLength value="5"/>
          <xs: minLength value="1"/>
        </xs: restriction>
      </xs: simpleType>
    </xs: element>
    <xs: element name="Bewertungsrelation" minOccurs="0">
      <xs: annotation>
        <xs: documentation>EKH17: Eff. Bewertungsrelation der
KH-PEPP</xs: documentation>
      </xs: annotation>
      <xs: simpleType>
        <xs: restriction base="xs: decimal">
          <xs: totalDigits value="8"/>
          <xs: fractionDigits value="4"/>
          <xs: maxExclusive value="10000"/>
        </xs: restriction>
      </xs: simpleType>
    </xs: element>
    <xs: element name="Basisentgeltwert" minOccurs="0">
      <xs: annotation>
        <xs: documentation>EKH18: Basisentgeltwert am
Aufnahmetag</xs: documentation>
      </xs: annotation>
      <xs: simpleType>
        <xs: restriction base="xs: decimal">
          <xs: totalDigits value="7"/>
          <xs: fractionDigits value="2"/>

```

```

        <xs: maxExcl usi ve val ue="100000" />
        </xs: restri cti on>
    </xs: si mpl eType>
</xs: el ement>
<xs: el ement name="Basi sentgel twert_Entl as" mi nOccurs="0">
    <xs: annotati on>
        <xs: documentati on>EKH19: Basi sentgel twert am
Entl assungstag</xs: documentati on>
    </xs: annotati on>
    <xs: si mpl eType>
        <xs: restri cti on base="xs: deci mal ">
            <xs: total Di gi ts val ue="7" />
            <xs: fracti onDi gi ts val ue="2" />
            <xs: maxExcl usi ve val ue="100000" />
        </xs: restri cti on>
    </xs: si mpl eType>
</xs: el ement>
<xs: el ement name="Basi sentgel twert_Entl as_Guel t"
type="md: Datum_Stp" mi nOccurs="0">
    <xs: annotati on>
        <xs: documentati on>EKH20: Basi sentgel twert am
Entl assungstag gültig ab</xs: documentati on>
    </xs: annotati on>
</xs: el ement>
</xs: sequen ce>
</xs: choi ce>
</xs: sequen ce>
<xs: attri bute name="entl assungsdatum" type="md: Datum_Stp"
use="requi red">
    <xs: annotati on>
        <xs: documentati on>EKH01: Datum Krankenhaus Entl assung im Format
(JJJJ-MM-TT)</xs: documentati on>
    </xs: annotati on>
</xs: attri bute>
<xs: attri bute name="entl assungszei t" type="xs: ti me" use="requi red">
    <xs: annotati on>
        <xs: documentati on>EKH02: Uhrzei t Krankenhaus Entl assung im
Format (HH: MM: SS)</xs: documentati on>
    </xs: annotati on>
</xs: attri bute>
<xs: attri bute name="fachabtei lung" type="kh: Fachabtei lung"
use="requi red">
    <xs: annotati on>
        <xs: documentati on>EKH03: Fachabtei lungs- schüssel der
entl assenden Abtei lung</xs: documentati on>
    </xs: annotati on>
</xs: attri bute>
<xs: attri bute name="abtei lungstyp" type="md: Abtei lungstyp_Stp"
use="opti onal ">
    <xs: annotati on>
        <xs: documentati on>EKH04: Zusatzschlüssel
Abtei lungstyp</xs: documentati on>
    </xs: annotati on>
</xs: attri bute>
<xs: attri bute name="entl assungsgrund" type="kh: Entl assungsgrund"

```



```

use="required">
    <xs: annotation>
    <xs: documentation>EKH05: Grund der
Entlassung/Verlegung</xs: documentation>
    </xs: annotation>
    </xs: attribute>
</xs: complexType>
</xs: element>
<xs: element name="Verlegungen" minOccurs="0" maxOccurs="999">
    <xs: annotation>
    <xs: documentation>LKH-Sätze </xs: documentation>
    </xs: annotation>
    <xs: complexType>
    <xs: attribute name="von" type="md: Datum_Stp" use="optional">
    <xs: annotation>
    <xs: documentation>LKH01: Datum Behandlung von im Format
(JJJJ-MM-TT)</xs: documentation>
    </xs: annotation>
    </xs: attribute>
    <xs: attribute name="bis" type="md: Datum_Stp" use="required">
    <xs: annotation>
    <xs: documentation>LKH02: Datum Behandlung bis/Verlegung am im
Format (JJJJ-MM-TT)</xs: documentation>
    </xs: annotation>
    </xs: attribute>
    <xs: attribute name="fachabteilung" type="kh: Fachabteilung"
use="required">
    <xs: annotation>
    <xs: documentation>LKH03: Fachabteilung</xs: documentation>
    </xs: annotation>
    </xs: attribute>
    <xs: attribute name="verlegungsgrund" type="kh: Entlassungsgrund"
use="required">
    <xs: annotation>
    <xs: documentation>LKH04: Entlassungs/
Verlegungsgrund</xs: documentation>
    </xs: annotation>
    </xs: attribute>
    <xs: attribute name="uhrzeit" type="xs: time" use="required">
    <xs: annotation>
    <xs: documentation>LKH05: Entlassungs-/Verlegungsuhrzeit im
Format (HH: MM: SS)</xs: documentation>
    </xs: annotation>
    </xs: attribute>
    </xs: complexType>
</xs: element>
<xs: element name="Entgelte" minOccurs="0" maxOccurs="999">
    <xs: annotation>
    <xs: documentation>ETG-Sätze </xs: documentation>
    </xs: annotation>
    <xs: complexType>
    <xs: attribute name="entgeltart" use="required">
    <xs: annotation>
    <xs: documentation>ETG01: Entgeltart</xs: documentation>
    </xs: annotation>

```

```

<xs:simpleType>
  <xs:restriction base="kh:Entgeltart">
    <xs:length value="8"/>
  </xs:restriction>
</xs:simpleType>
</xs:attribute>
<xs:attribute name="bezeichnung" use="required">
  <xs:annotation>
    <xs:documentation>ETG02: Bezeichnung des Entgelts
  </xs:documentation>
</xs:annotation>
<xs:simpleType>
  <xs:restriction base="kh:Bezeichnung_Entgelt"/>
</xs:simpleType>
</xs:attribute>
<xs:attribute name="betrag" use="optional">
  <xs:annotation>
    <xs:documentation>ETG03: Entgeltbetrag </xs:documentation>
  </xs:annotation>
<xs:simpleType>
  <xs:restriction base="xs:decimal">
    <xs:fractionDigits value="2" fixed="false"/>
    <xs:totalDigits value="9"/>
    <xs:maxExclusive value="100000000"/>
  </xs:restriction>
</xs:simpleType>
</xs:attribute>
<xs:attribute name="abrechnung_von" type="md:Datum_Stp"
use="optional">
  <xs:annotation>
    <xs:documentation>ETG04: Entgelt Abrechnung von im
Format(JJJJ-MM-TT)</xs:documentation>
  </xs:annotation>
</xs:attribute>
<xs:attribute name="abrechnung_bis" type="md:Datum_Stp"
use="optional">
  <xs:annotation>
    <xs:documentation>ETG05: Entgelt Abrechnung bis im
Format(JJJJ-MM-TT)</xs:documentation>
  </xs:annotation>
</xs:attribute>
<xs:attribute name="entgelt_anzahl" type="kh:Anzahl_Tage3"
use="required">
  <xs:annotation>
    <xs:documentation>ETG06: Anzahl des
Entgeltschlüssels</xs:documentation>
  </xs:annotation>
</xs:attribute>
<xs:attribute name="TOB" type="kh:Anzahl_Tage3" use="optional">
  <xs:annotation>
    <xs:documentation>ETG07: Tage ohne
Berechnung/Behandlung</xs:documentation>
  </xs:annotation>
</xs:attribute>
<xs:attribute name="kz_pruefung" use="optional">

```

```

        <xs: annotation>
          <xs: documentation>ETG08: Kennzeichen - Gesonderte Prüfung durch
MD gewünscht</xs: documentation>
        </xs: annotation>
        <xs: simpleType>
          <xs: restriction base="xs:string">
            <xs:length value="1"/>
            <xs:enumeration value="1"/>
          </xs:restriction>
        </xs: simpleType>
      </xs: attribute>
    </xs: complexType>
  </xs: element>
  <xs: element name="Aktzeichen_anderer_Begutachtungsfall"
type="md:Aktzeichen_anderer_Begutachtungsfall_Ctp" minOccurs="0" maxOccurs="9">
    <xs: annotation>
      <xs: documentation>AAB: Aktzeichen anderer
Begutachtungsfall </xs: documentation>
    </xs: annotation>
  </xs: element>
  <xs: element name="Standorte" minOccurs="0" maxOccurs="99">
    <xs: annotation>
      <xs: documentation>STA-Sätze</xs: documentation>
    </xs: annotation>
    <xs: complexType>
      <xs: attribute name="standortnummer" use="required">
        <xs: annotation>
          <xs: documentation>STA01: Standortnummer</xs: documentation>
        </xs: annotation>
      <xs: simpleType>
        <xs: restriction base="xs:string">
          <xs:length value="9"/>
        </xs:restriction>
      </xs: simpleType>
      <xs: attribute name="ende_datum" type="md:Datum_Stp" use="required">
        <xs: annotation>
          <xs: documentation>STA02: Standort Ende im Format
(JJJJ-MM-TT)</xs: documentation>
        </xs: annotation>
      </xs: attribute>
      <xs: attribute name="ende_zeit" type="xs:time" use="required">
        <xs: annotation>
          <xs: documentation>STA03: Standort Ende Uhrzeit im Format
(HH:MM:SS)</xs: documentation>
        </xs: annotation>
      </xs: attribute>
    </xs: complexType>
  </xs: element>
</xs: sequence>
</xs: complexType>
</xs: element>
</xs: sequence>
<xs: attribute name="geltungsbereich" type="kh:Abrechnungsart" use="required">
  <xs: annotation>

```

```

    <xs:documentation>AKH01: Gesetzlicher Geltungsbereich der
Abrechnung</xs:documentation>
  </xs:annotation>
</xs:attribute>
<xs:attribute name="fall_ID" use="required">
  <xs:annotation>
    <xs:documentation>AKH02: Fall-ID KH (Aufnahmenummer)</xs:documentation>
  </xs:annotation>
  <xs:simpleType>
    <xs:restriction base="kh:fall_ID">
      <xs:minLength value="1"/>
    </xs:restriction>
  </xs:simpleType>
</xs:attribute>
<xs:attribute name="rechnungsnummer" type="kh:Rechnungsnummer" use="optional">
  <xs:annotation>
    <xs:documentation>AKH03: Rechnungsnummer</xs:documentation>
  </xs:annotation>
</xs:attribute>
<xs:attribute name="rechnungsdatum" type="md:Datum_Stp" use="optional">
  <xs:annotation>
    <xs:documentation>AKH04: Rechnungsdatum im Format
(JJJJ-MM-TT)</xs:documentation>
  </xs:annotation>
</xs:attribute>
<xs:attribute name="rechnungseingang" type="md:Datum_Stp" use="optional">
  <xs:annotation>
    <xs:documentation>AKH05: Datum des Rechnungseingang im Format
(JJJJ-MM-TT)</xs:documentation>
  </xs:annotation>
</xs:attribute>
<xs:attribute name="auftragsart" type="kh:Auftragsart" use="required">
  <xs:annotation>
    <xs:documentation>AKH06: Auftragsart </xs:documentation>
  </xs:annotation>
</xs:attribute>
<xs:attribute name="anlagen_PDF" use="required">
  <xs:annotation>
    <xs:documentation>AKH07: Anzahl der Anlagen</xs:documentation>
  </xs:annotation>
  <xs:simpleType>
    <xs:restriction base="xs:string">
      <xs:length value="1"/>
      <xs:pattern value="[0-9]"/>
    </xs:restriction>
  </xs:simpleType>
</xs:attribute>
<xs:attribute name="anlagen_post" use="required">
  <xs:annotation>
    <xs:documentation>AKH08: Anzahl der Anlagen per Postweg</xs:documentation>
  </xs:annotation>
  <xs:simpleType>
    <xs:restriction base="xs:string">
      <xs:length value="1"/>
      <xs:pattern value="[0-9]"/>
    </xs:restriction>
  </xs:simpleType>

```

```

        </xs: restricti on>
    </xs: si mpl eType>
</xs: attri bute>
    <xs: attri bute name="anl agen_post_text" type="md: Frei text_Mi t_Zei chen_Stp"
use="opti onal ">
        <xs: annotati on>
            <xs: documentati on>AKH09: Erl äuterung Anl agen per Postweg</xs: documentati on>
        </xs: annotati on>
    </xs: attri bute>
    <xs: attri bute name="unterl agen_bei MD" use="opti onal ">
        <xs: annotati on>
            <xs: documentati on>AKH10: Unterl agen l iegen berei ts beim MD
vor</xs: documentati on>
        </xs: annotati on>
        <xs: si mpl eType>
            <xs: restricti on base="xs: string">
                <xs: length value="1"/>
                <xs: enumerati on value="1"/>
            </xs: restricti on>
        </xs: si mpl eType>
    </xs: attri bute>
    <xs: attri bute name="unterl agen_bei MD_text" type="md: Frei text_Mi t_Zei chen_Stp"
use="opti onal ">
        <xs: annotati on>
            <xs: documentati on>AKH11: Erl äuterung Unterl agen, di e berei ts beim MD
vorl iegen</xs: documentati on>
        </xs: annotati on>
    </xs: attri bute>
    <xs: attri bute name="vorverfahren_ergebni s" type="kh: Vorverf_Ergebni s"
use="opti onal ">
        <xs: annotati on>
            <xs: documentati on>AKH12: Ergebni s Vorverfahren</xs: documentati on>
        </xs: annotati on>
    </xs: attri bute>
    <xs: attri bute name="ber_erw_fragestel lung" type="kh: Ber_Erw_Fragestel lung"
use="requi red">
        <xs: annotati on>
            <xs: documentati on>AKH13: Berechtigung des MD zur Ergänz ung der
Fragestel lung</xs: documentati on>
        </xs: annotati on>
    </xs: attri bute>
    <xs: attri bute name="wechsel_auftragsart" type="kh: Wechsel_Auftragsart"
use="requi red">
        <xs: annotati on>
            <xs: documentati on>AKH14: Berechtigung des MD zum Wechsel der
Auftragsart</xs: documentati on>
        </xs: annotati on>
    </xs: attri bute>
    <xs: attri bute name="ber_erw_pruefgegenstand"
type="kh: Berechtigung_Erwei terung_Pruefgegenstand" use="requi red">
        <xs: annotati on>
            <xs: documentati on>AKH15: Berechtigung des MD zur Erwei terung des
Prüfgegenstandes</xs: documentati on>
        </xs: annotati on>
    </xs: attri bute>

```

	<pre> </xs:complexType> </xs:element> </pre>
--	--

attribute Beauftragung/Auftrag/@geltungsbereich

type	Abrechnungsart												
properties	use required												
facets	<table border="1"> <thead> <tr> <th>Kind</th> <th>Value</th> <th>Annotation</th> </tr> </thead> <tbody> <tr> <td>enumeration</td> <td>01</td> <td></td> </tr> <tr> <td>enumeration</td> <td>02</td> <td></td> </tr> <tr> <td>enumeration</td> <td>09</td> <td></td> </tr> </tbody> </table>	Kind	Value	Annotation	enumeration	01		enumeration	02		enumeration	09	
Kind	Value	Annotation											
enumeration	01												
enumeration	02												
enumeration	09												
annotation	documentation AKH01: Gesetzlicher Geltungsbereich der Abrechnung												
source	<pre> <xs:attribute name="geltungsbereich" type="kh:Abrechnungsart" use="required"> <xs:annotation> <xs:documentation>AKH01: Gesetzlicher Geltungsbereich der Abrechnung</xs:documentation> </xs:annotation> </xs:attribute> </pre>												

attribute Beauftragung/Auftrag/@fall_ID

type	restriction of Fall_ID									
properties	use required									
facets	<table border="1"> <thead> <tr> <th>Kind</th> <th>Value</th> <th>Annotation</th> </tr> </thead> <tbody> <tr> <td>minLength</td> <td>1</td> <td></td> </tr> <tr> <td>maxLength</td> <td>15</td> <td></td> </tr> </tbody> </table>	Kind	Value	Annotation	minLength	1		maxLength	15	
Kind	Value	Annotation								
minLength	1									
maxLength	15									
annotation	documentation AKH02: Fall-ID KH (Aufnahmenummer)									
source	<pre> <xs:attribute name="fall_ID" use="required"> <xs:annotation> <xs:documentation>AKH02: Fall-ID KH (Aufnahmenummer)</xs:documentation> </xs:annotation> <xs:simpleType> <xs:restriction base="kh:Fall_ID"> <xs:minLength value="1"/> </xs:restriction> </xs:simpleType> </xs:attribute> </pre>									

attribute Beauftragung/Auftrag/@rechnungsnummer

type	Rechnungsnummer						
properties	use optional						
facets	<table border="1"> <thead> <tr> <th>Kind</th> <th>Value</th> <th>Annotation</th> </tr> </thead> <tbody> <tr> <td>maxLength</td> <td>20</td> <td></td> </tr> </tbody> </table>	Kind	Value	Annotation	maxLength	20	
Kind	Value	Annotation					
maxLength	20						

annotation	documentation AKH03: Rechnungsnummer
source	<xs:attribute name="rechnungsnummer" type="kh:Rechnungsnummer" use="optional"> <xs:annotation> <xs:documentation>AKH03: Rechnungsnummer</xs:documentation> </xs:annotation> </xs:attribute>

attribute Beauftragung/Auftrag/@rechnungsdatum

type	Datum_Stp									
properties	use optional									
facets	<table border="1"> <thead> <tr> <th>Kind</th> <th>Value</th> <th>Annotation</th> </tr> </thead> <tbody> <tr> <td>minInclusive</td> <td>1850-01-01</td> <td></td> </tr> <tr> <td>maxInclusive</td> <td>2099-12-31</td> <td></td> </tr> </tbody> </table>	Kind	Value	Annotation	minInclusive	1850-01-01		maxInclusive	2099-12-31	
Kind	Value	Annotation								
minInclusive	1850-01-01									
maxInclusive	2099-12-31									
annotation	documentation AKH04: Rechnungsdatum im Format (JJJ-MM-TT)									
source	<xs:attribute name="rechnungsdatum" type="md:Datum_Stp" use="optional"> <xs:annotation> <xs:documentation>AKH04: Rechnungsdatum im Format (JJJ-MM-TT)</xs:documentation> </xs:annotation> </xs:attribute>									

attribute Beauftragung/Auftrag/@rechnungseingang

type	Datum_Stp									
properties	use optional									
facets	<table border="1"> <thead> <tr> <th>Kind</th> <th>Value</th> <th>Annotation</th> </tr> </thead> <tbody> <tr> <td>minInclusive</td> <td>1850-01-01</td> <td></td> </tr> <tr> <td>maxInclusive</td> <td>2099-12-31</td> <td></td> </tr> </tbody> </table>	Kind	Value	Annotation	minInclusive	1850-01-01		maxInclusive	2099-12-31	
Kind	Value	Annotation								
minInclusive	1850-01-01									
maxInclusive	2099-12-31									
annotation	documentation AKH05: Datum des Rechnungseingang im Format (JJJ-MM-TT)									
source	<xs:attribute name="rechnungseingang" type="md:Datum_Stp" use="optional"> <xs:annotation> <xs:documentation>AKH05: Datum des Rechnungseingang im Format (JJJ-MM-TT)</xs:documentation> </xs:annotation> </xs:attribute>									

attribute Beauftragung/Auftrag/@auftragsart

type	Auftragsart									
properties	use required									
facets	<table border="1"> <thead> <tr> <th>Kind</th> <th>Value</th> <th>Annotation</th> </tr> </thead> <tbody> <tr> <td>enumeration</td> <td>01</td> <td></td> </tr> <tr> <td>enumeration</td> <td>02</td> <td></td> </tr> </tbody> </table>	Kind	Value	Annotation	enumeration	01		enumeration	02	
Kind	Value	Annotation								
enumeration	01									
enumeration	02									

	enumeration 03 enumeration 04 enumeration 05 enumeration 06 enumeration 07 enumeration 08 enumeration 09 enumeration 10 enumeration 11
annotation	documentation AKH06: Auftragsart
source	<pre><xs:attribute name="auftragsart" type="kh: Auftragsart" use="required"> <xs:annotation> <xs:documentation>AKH06: Auftragsart </xs:documentation> </xs:annotation> </xs:attribute></pre>

attribute Beauftragung/Auftrag/@anlagen_PDF

type	restriction of xs:string									
properties	use required									
facets	<table border="1"> <thead> <tr> <th>Kind</th> <th>Value</th> <th>Annotation</th> </tr> </thead> <tbody> <tr> <td>length</td> <td>1</td> <td></td> </tr> <tr> <td>pattern</td> <td>[0-9]</td> <td></td> </tr> </tbody> </table>	Kind	Value	Annotation	length	1		pattern	[0-9]	
Kind	Value	Annotation								
length	1									
pattern	[0-9]									
annotation	documentation AKH07: Anzahl der Anlagen									
source	<pre><xs:attribute name="anlagen_PDF" use="required"> <xs:annotation> <xs:documentation>AKH07: Anzahl der Anlagen</xs:documentation> </xs:annotation> <xs:simpleType> <xs:restriction base="xs:string"> <xs:length value="1"/> <xs:pattern value="[0-9]"/> </xs:restriction> </xs:simpleType> </xs:attribute></pre>									

attribute Beauftragung/Auftrag/@anlagen_post

type	restriction of xs:string									
properties	use required									
facets	<table border="1"> <thead> <tr> <th>Kind</th> <th>Value</th> <th>Annotation</th> </tr> </thead> <tbody> <tr> <td>length</td> <td>1</td> <td></td> </tr> <tr> <td>pattern</td> <td>[0-9]</td> <td></td> </tr> </tbody> </table>	Kind	Value	Annotation	length	1		pattern	[0-9]	
Kind	Value	Annotation								
length	1									
pattern	[0-9]									
annotation	documentation AKH08: Anzahl der Anlagen per Postweg									

source	<pre> <xs:attribute name="anlagen_post" use="required"> <xs:annotation> <xs:documentation>AKH08: Anzahl der Anlagen per Postweg</xs:documentation> </xs:annotation> <xs:simpleType> <xs:restriction base="xs:string"> <xs:length value="1"/> <xs:pattern value="[0-9]"/> </xs:restriction> </xs:simpleType> </xs:attribute> </pre>
--------	--

attribute Beauftragung/Auftrag/@anlagen_post_text

type	Freitext Mit Zeichen_Stp									
properties	use optional									
facets	<table border="1"> <thead> <tr> <th>Kind</th> <th>Value</th> <th>Annotation</th> </tr> </thead> <tbody> <tr> <td>minLength</td> <td>1</td> <td></td> </tr> <tr> <td>maxLength</td> <td>255</td> <td></td> </tr> </tbody> </table>	Kind	Value	Annotation	minLength	1		maxLength	255	
Kind	Value	Annotation								
minLength	1									
maxLength	255									
annotation	documentation AKH09: Erläuterung Anlagen per Postweg									
source	<pre> <xs:attribute name="anlagen_post_text" type="md:Freitext_Mit_Zeichen_Stp" use="optional"> <xs:annotation> <xs:documentation>AKH09: Erläuterung Anlagen per Postweg</xs:documentation> </xs:annotation> </xs:attribute> </pre>									

attribute Beauftragung/Auftrag/@unterlagen_beimMD

type	restriction of xs:string									
properties	use optional									
facets	<table border="1"> <thead> <tr> <th>Kind</th> <th>Value</th> <th>Annotation</th> </tr> </thead> <tbody> <tr> <td>length</td> <td>1</td> <td></td> </tr> <tr> <td>enumeration</td> <td>1</td> <td></td> </tr> </tbody> </table>	Kind	Value	Annotation	length	1		enumeration	1	
Kind	Value	Annotation								
length	1									
enumeration	1									
annotation	documentation AKH10: Unterlagen liegen bereits beim MD vor									
source	<pre> <xs:attribute name="unterlagen_beimMD" use="optional"> <xs:annotation> <xs:documentation>AKH10: Unterlagen liegen bereits beim MD vor</xs:documentation> </xs:annotation> <xs:simpleType> <xs:restriction base="xs:string"> <xs:length value="1"/> <xs:enumeration value="1"/> </xs:restriction> </xs:simpleType> </xs:attribute> </pre>									

attribute Beauftragung/Auftrag/@unterlagen_beiMD_text

type	Freitext Mit Zeichen Stp									
properties	use optional									
facets	<table border="1"> <thead> <tr> <th>Kind</th> <th>Value</th> <th>Annotation</th> </tr> </thead> <tbody> <tr> <td>minLength</td> <td>1</td> <td></td> </tr> <tr> <td>maxLength</td> <td>255</td> <td></td> </tr> </tbody> </table>	Kind	Value	Annotation	minLength	1		maxLength	255	
Kind	Value	Annotation								
minLength	1									
maxLength	255									
annotation	documentation AKH11: Erläuterung Unterlagen, die bereits beim MD vorliegen									
source	<pre><xs:attribute name="unterlagen_beiMD_text" type="md:Freitext_Mit_Zeichen_Stp" use="optional"> <xs:annotation> <xs:documentation>AKH11: Erläuterung Unterlagen, die bereits beim MD vorliegen</xs:documentation> </xs:annotation> </xs:attribute></pre>									

attribute Beauftragung/Auftrag/@vorverfahren_ergebnis

type	Vorverf Ergebnis															
properties	use optional															
facets	<table border="1"> <thead> <tr> <th>Kind</th> <th>Value</th> <th>Annotation</th> </tr> </thead> <tbody> <tr> <td>enumeration</td> <td>A</td> <td></td> </tr> <tr> <td>enumeration</td> <td>B</td> <td></td> </tr> <tr> <td>enumeration</td> <td>D</td> <td></td> </tr> <tr> <td>enumeration</td> <td>E</td> <td></td> </tr> </tbody> </table>	Kind	Value	Annotation	enumeration	A		enumeration	B		enumeration	D		enumeration	E	
Kind	Value	Annotation														
enumeration	A															
enumeration	B															
enumeration	D															
enumeration	E															
annotation	documentation AKH12: Ergebnis Vorverfahren															
source	<pre><xs:attribute name="vorverfahren_ergebnis" type="kh:Vorverf_Ergebnis" use="optional"> <xs:annotation> <xs:documentation>AKH12: Ergebnis Vorverfahren</xs:documentation> </xs:annotation> </xs:attribute></pre>															

attribute Beauftragung/Auftrag/@ber_erw_fragestellung

type	Ber_Erw_Fragestellung						
properties	use required						
facets	<table border="1"> <thead> <tr> <th>Kind</th> <th>Value</th> <th>Annotation</th> </tr> </thead> <tbody> <tr> <td>enumeration</td> <td>1</td> <td></td> </tr> </tbody> </table>	Kind	Value	Annotation	enumeration	1	
Kind	Value	Annotation					
enumeration	1						
annotation	documentation AKH13: Berechtigung des MD zur Ergänzung der Fragestellung						
source	<pre><xs:attribute name="ber_erw_fragestellung" type="kh:Ber_Erw_Fragestellung" use="required"> <xs:annotation></pre>						

	<pre> <xs:documentation>AKH13: Berechtigung des MD zur Ergänzung der Fragestellung</xs:documentation> </xs:annotation> </xs:attribute> </pre>
--	---

attribute Beauftragung/Auftrag/@wechsel_auftragsart

type	Wechsel_Auftragsart						
properties	use required						
facets	<table border="1"> <tr> <td>Kind</td> <td>Value</td> <td>Annotation</td> </tr> <tr> <td>enumeration</td> <td>0</td> <td></td> </tr> </table>	Kind	Value	Annotation	enumeration	0	
Kind	Value	Annotation					
enumeration	0						
annotation	<pre> documentation AKH14: Berechtigung des MD zum Wechsel der Auftragsart </pre>						
source	<pre> <xs:attribute name="wechsel_auftragsart" type="kh: Wechsel_Auftragsart" use="required"> <xs:annotation> <xs:documentation>AKH14: Berechtigung des MD zum Wechsel der Auftragsart</xs:documentation> </xs:annotation> </xs:attribute> </pre>						

attribute Beauftragung/Auftrag/@ber_erw_pruefgegenstand

type	Berechtigung_Erweiterung_Pruefgegenstand									
properties	use required									
facets	<table border="1"> <tr> <td>Kind</td> <td>Value</td> <td>Annotation</td> </tr> <tr> <td>enumeration</td> <td>0</td> <td></td> </tr> <tr> <td>enumeration</td> <td>1</td> <td></td> </tr> </table>	Kind	Value	Annotation	enumeration	0		enumeration	1	
Kind	Value	Annotation								
enumeration	0									
enumeration	1									
annotation	<pre> documentation AKH15: Berechtigung des MD zur Erweiterung des Prüfgegenstandes </pre>									
source	<pre> <xs:attribute name="ber_erw_pruefgegenstand" type="kh: Berechtigung_Erweiterung_Pruefgegenstand" use="required"> <xs:annotation> <xs:documentation>AKH15: Berechtigung des MD zur Erweiterung des Prüfgegenstandes</xs:documentation> </xs:annotation> </xs:attribute> </pre>									

element Beauftragung/Auftrag/Fragen

diagram													
namespace	http://www.aok-systems.de/xml-schema/mdk-kh-standard_V07.00												
type	CT_Fragestellung												
properties	minOcc 0 maxOcc 1 content complex												
children	frage												
identity constraints	<table border="1"> <thead> <tr> <th></th> <th>Name</th> <th>Refer</th> <th>Selector</th> <th>Field(s)</th> <th>Annotation</th> </tr> </thead> <tbody> <tr> <td>unique</td> <td>key_frage</td> <td></td> <td>kh:frage</td> <td>@frage_ID</td> <td></td> </tr> </tbody> </table>		Name	Refer	Selector	Field(s)	Annotation	unique	key_frage		kh:frage	@frage_ID	
	Name	Refer	Selector	Field(s)	Annotation								
unique	key_frage		kh:frage	@frage_ID									
annotation	documentation Fragestellungen der Krankenkasse												
source	<pre> <xs:element name="Fragen" type="kh:CT_Fragestellung" minOccurs="0"> <xs:annotation> <xs:documentation>Fragestellungen der Krankenkasse</xs:documentation> </xs:annotation> <xs:unique name="key_frage"> <xs:selector xpath="kh:frage"/> <xs:field xpath="@frage_ID"/> </xs:unique> </xs:element> </pre>												

element Beauftragung/Auftrag/Infos

<p>diagram</p>	
<p>namespace</p>	<p>http://www.aok-systems.de/xml-schema/mdk-kh-standard_V07.00</p>
<p>properties</p>	<p>content complex</p>
<p>children</p>	<p>Leistungserbringer Pruefgegenstaende Falldaten Verlaengerungen Diagnosen Prozeduren Entlassung Verlegungen Entgelte Aktenzeichen_anderer_Begutachtungsfall Standorte</p>
<p>annotation</p>	<p>documentation Notwendige Informationen</p>
<p>source</p>	<pre><xs:element name="Infos" > <xs:annotation> <xs:documentation>Notwendige Informationen</xs:documentation> </xs:annotation></pre>

```

<xs:complexType>
  <xs:sequence>
    <xs:element name="Leistungserbringer" type="md:Leistungserbringer_Ctp">
      <xs:annotation>
        <xs:documentation>SDL: Stammdaten Leistungserbringer</xs:documentation>
      </xs:annotation>
    </xs:element>
    <xs:element name="Pruefgegenstaende" type="kh:CT_Pruefgegenstand"
      minOccurs="0">
      <xs:annotation>
        <xs:documentation>PGS-Sätze: Prüfgegenstand</xs:documentation>
      </xs:annotation>
      <xs:unique name="key_preufgegenstand">
        <xs:selector xpath="kh:Pruefgegenstand"/>
        <xs:field xpath="@pruefgegenstand"/>
      </xs:unique>
    </xs:element>
    <xs:element name="Fall daten">
      <xs:annotation>
        <xs:documentation>FKH-Satz</xs:documentation>
      </xs:annotation>
      <xs:complexType>
        <xs:sequence>
          <xs:element name="Aufnahme">
            <xs:annotation>
              <xs:documentation>FKH01-05</xs:documentation>
            </xs:annotation>
            <xs:complexType>
              <xs:attribute name="tag" type="md:Datum_Stp" use="required">
                <xs:annotation>
                  <xs:documentation>FKH01: Datum Krankenhaus-Aufnahme im Format
                    (JJJJ-MM-TT)</xs:documentation>
                </xs:annotation>
              </xs:attribute>
              <xs:attribute name="uhrzeit" type="xs:time" use="required">
                <xs:annotation>
                  <xs:documentation>FKH02: Uhrzeit Krankenhaus-Aufnahme im
                    Format (HH:MM:SS)</xs:documentation>
                </xs:annotation>
              </xs:attribute>
              <xs:attribute name="aufnahmegrund" use="required">
                <xs:annotation>
                  <xs:documentation>FKH03: Aufnahmegrund </xs:documentation>
                </xs:annotation>
              <xs:simpleType>
                <xs:restriction base="kh:Aufnahmegrund"/>
              </xs:simpleType>
              <xs:attribute name="aufnahmeanlass" type="kh:Aufnahmeanlass"
                use="required">
                <xs:annotation>
                  <xs:documentation>FKH04: Aufnahmeanlass </xs:documentation>
                </xs:annotation>
              </xs:attribute>
              <xs:attribute name="fachabteilung" type="kh:Fachabteilung"

```

```

use="required">
    <xs: annotation>
        <xs: documentation>FKH05: Fachabteilung</xs: documentation>
    </xs: annotation>
</xs: attribute>
</xs: complexType>
</xs: element>
<xs: element name="Entlassung" type="md: Datum_Stp" minOccurs="0">
    <xs: annotation>
        <xs: documentation>FKH06: Voraussichtliches Entlassungsdatum im
Format (JJJJ-MM-TT)</xs: documentation>
    </xs: annotation>
</xs: element>
<xs: element name="Arztnummer" minOccurs="0">
    <xs: annotation>
        <xs: documentation>FKH07: Arzt-Nummer des einweisenden
Arztes</xs: documentation>
    </xs: annotation>
    <xs: simpleType>
        <xs: restriction base="kh: Arztnummer"/>
    </xs: simpleType>
</xs: element>
<xs: element name="IK_Stelle" type="kh: IK_Stelle" minOccurs="0">
    <xs: annotation>
        <xs: documentation>FKH08: IK der veranlassenden
Stelle</xs: documentation>
    </xs: annotation>
</xs: element>
<xs: element name="Stelle_Notfall" type="kh: Name_Stelle_Notfall"
minOccurs="0">
    <xs: annotation>
        <xs: documentation>FKH09: Veranlassende Stelle bei
Notfallaufnahme</xs: documentation>
    </xs: annotation>
</xs: element>
<xs: element name="Zahnarztnummer" minOccurs="0">
    <xs: annotation>
        <xs: documentation>FKH10: Arzt-Nummer des einweisenden
Zahnarztes</xs: documentation>
    </xs: annotation>
    <xs: simpleType>
        <xs: restriction base="kh: Arztnummer"/>
    </xs: simpleType>
</xs: element>
<xs: element name="Gewicht" minOccurs="0">
    <xs: annotation>
        <xs: documentation>FKH11: Aufnahmegewicht in
Gramm</xs: documentation>
    </xs: annotation>
    <xs: simpleType>
        <xs: restriction base="xs: int">
            <xs: minOccurs value="0"/>
            <xs: maxInclusive value="99999"/>
        </xs: restriction>
    </xs: simpleType>

```

```

        </xs:element>
        <xs:element name="Behandlungsart" type="kh:Behandlungsart"
mi n0ccurs="0">
            <xs:annotation>
                <xs:documentation>FKH14: Behandlungsart</xs:documentation>
            </xs:annotation>
        </xs:element>
    </xs:sequence>
</xs:complexType>
</xs:element>
<xs:element name="Verlaengerungen" mi n0ccurs="0" max0ccurs="99">
    <xs:annotation>
        <xs:documentation>VKH-Sätze</xs:documentation>
    </xs:annotation>
    <xs:complexType>
        <xs:attribute name="aufnahme" type="md:Datum_Stp" use="required">
            <xs:annotation>
                <xs:documentation>VKH01: Datum der Aufnahme in Fachabteilung im
Format (JJJJ-MM-TT)</xs:documentation>
            </xs:annotation>
        </xs:attribute>
        <xs:attribute name="entlassung" type="md:Datum_Stp" use="required">
            <xs:annotation>
                <xs:documentation>VKH02: Voraussichtliches Entlassungsdatum im
Format (JJJJ-MM-TT)</xs:documentation>
            </xs:annotation>
        </xs:attribute>
    </xs:complexType>
</xs:element>
<xs:element name="Diagnosen">
    <xs:annotation>
        <xs:documentation>DIA-Satz und FKH12</xs:documentation>
    </xs:annotation>
    <xs:complexType>
        <xs:sequence>
            <xs:element name="Diagnose" max0ccurs="999">
                <xs:annotation>
                    <xs:documentation>DIA-Sätze </xs:documentation>
                </xs:annotation>
                <xs:complexType>
                    <xs:attribute name="diagnosetyp" type="kh:Diagnosetyp"
use="required">
                        <xs:annotation>
                            <xs:documentation>DIA01: Diagnosentyp</xs:documentation>
                        </xs:annotation>
                    </xs:attribute>
                    <xs:attribute name="icd" use="required">
                        <xs:annotation>
                            <xs:documentation>DIA02: ICD-Schlüssel </xs:documentation>
                        </xs:annotation>
                    </xs:simpleType>
                    <xs:restriction base="md:ICD_Schlüssel_Stp">
                        <xs:minLength value="3"/>
                    </xs:restriction>
                </xs:simpleType>
            </xs:element>
        </xs:sequence>
    </xs:complexType>

```



```

        </xs: attribute>
        <xs: attribute name="lokalisation" type="md:Lokalisation_Stp"
use="optional">
            <xs: annotation>
                <xs: documentation>DIA03: Lokalisation</xs: documentation>
            </xs: annotation>
        </xs: attribute>
        <xs: attribute name="kz_pruefung" use="optional">
            <xs: annotation>
                <xs: documentation>DIA04: Kennzeichen - Gesonderte Prüfung
durch MD gewünscht</xs: documentation>
            </xs: annotation>
            <xs: simpleType>
                <xs: restriction base="xs:string">
                    <xs:length value="1"/>
                    <xs:enumeration value="1"/>
                </xs: restriction>
            </xs: simpleType>
        </xs: attribute>
    </xs: complexType>
</xs: element>
</xs: sequence>
<xs: attribute name="icd_version" use="required">
    <xs: annotation>
        <xs: documentation>FKH12: ICD-Version</xs: documentation>
    </xs: annotation>
    <xs: simpleType>
        <xs: restriction base="xs:gYear">
            <xs:minInclusive value="2003"/>
            <xs:maxInclusive value="2099"/>
        </xs: restriction>
    </xs: simpleType>
</xs: attribute>
</xs: complexType>
</xs: element>
<xs: element name="Prozeduren" minOccurs="0">
    <xs: annotation>
        <xs: documentation>OPS-Satz und FKH13</xs: documentation>
    </xs: annotation>
    <xs: complexType>
        <xs: sequence>
            <xs: element name="Prozedur" minOccurs="0" maxOccurs="999">
                <xs: annotation>
                    <xs: documentation>OPS Datensätze </xs: documentation>
                </xs: annotation>
                <xs: complexType>
                    <xs: attribute name="ops" use="required">
                        <xs: annotation>
                            <xs: documentation>OPS01: OPS-Schlüssel </xs: documentation>
                        </xs: annotation>
                        <xs: simpleType>
                            <xs: restriction base="kh:OPS_Schluessel">
                                <xs:minLength value="1"/>
                            </xs: restriction>
                        </xs: simpleType>
                    </xs: complexType>
                </xs: element>
            </xs: sequence>
        </xs: element>
    </xs: complexType>
</xs: element>

```

```

        </xs: attribute>
        <xs: attribute name="lokalisation" type="md:Lokalisation_Stp"
use="optional">
            <xs: annotation>
                <xs: documentation>OPS02: Lokalisation</xs: documentation>
            </xs: annotation>
        </xs: attribute>
        <xs: attribute name="datum" type="md:Datum_Stp" use="optional">
            <xs: annotation>
                <xs: documentation>OPS03: Datum OPS im Format
(JJJJ-MM-TT)</xs: documentation>
            </xs: annotation>
        </xs: attribute>
        <xs: attribute name="kz_pruefung" use="optional">
            <xs: annotation>
                <xs: documentation>OPS04: Kennzeichen - Gesonderte Prüfung
durch MD gewünscht</xs: documentation>
            </xs: annotation>
            <xs: simpleType>
                <xs: restriction base="xs:string">
                    <xs: length value="1"/>
                    <xs: enumeration value="1"/>
                </xs: restriction>
            </xs: simpleType>
        </xs: attribute>
        </xs: complexType>
    </xs: element>
</xs: sequence>
<xs: attribute name="ops_version" use="required">
    <xs: annotation>
        <xs: documentation>FKH13: OPS-Version</xs: documentation>
    </xs: annotation>
    <xs: simpleType>
        <xs: restriction base="xs:gYear">
            <xs: minOccurs value="2003"/>
            <xs: maxInclusive value="2099"/>
        </xs: restriction>
    </xs: simpleType>
</xs: attribute>
</xs: complexType>
</xs: element>
<xs: element name="Entlassung" minOccurs="0">
    <xs: annotation>
        <xs: documentation>EKH-Satz</xs: documentation>
    </xs: annotation>
    <xs: complexType>
        <xs: sequence>
            <xs: element name="Entgeltart" type="kh:Entgeltart" minOccurs="0">
                <xs: annotation>
                    <xs: documentation>EKH06: Entgeltart</xs: documentation>
                </xs: annotation>
            </xs: element>
            <xs: element name="Beauftragungsstunden" minOccurs="0">
                <xs: annotation>
                    <xs: documentation>EKH11: Anzahl

```

```

Beatmungsstunden</xs:documentati on>
  </xs:annotati on>
  <xs:simpl eType>
    <xs:restric ti on base="xs:int">
      <xs:minIncl usi ve val ue="0"/>
      <xs:maxIncl usi ve val ue="9999"/>
    </xs:restric ti on>
  </xs:simpl eType>
</xs:el ement>
<xs:el ement name="Entbi ndung" type="md: Datum_Stp" mi nOccurs="0"
maxOccurs="2">
  <xs:annotati on>
    <xs:documentati on>EKH12-13: Tag der Entbi ndung im Format
(JJJJ-MM-TT)</xs:documentati on>
  </xs:annotati on>
</xs:el ement>
<xs:el ement name="TOB" type="kh: Anzahl _Tage3" mi nOccurs="0">
  <xs:annotati on>
    <xs:documentati on>EKH14: Tage ohne Berechnung
(TOB)</xs:documentati on>
  </xs:annotati on>
</xs:el ement>
<xs:choi ce>
  <xs:sequence>
    <xs:el ement name="KH_DRG" mi nOccurs="0">
      <xs:annotati on>
        <xs:documentati on>EKH07, EKH09</xs:documentati on>
      </xs:annotati on>
      <xs:compl exType>
        <xs:attri bute name="DRG" use="opti onal ">
          <xs:annotati on>
            <xs:documentati on>EKH07: Abgerechnete
KH-DRG</xs:documentati on>
          </xs:annotati on>
          <xs:simpl eType>
            <xs:restric ti on base="kh: DRG"/>
          </xs:simpl eType>
          <xs:attri bute>
            <xs:attri bute name="rel ati vgewi cht" use="opti onal ">
              <xs:annotati on>
                <xs:documentati on>EKH09: Eff. Rel ati vgewi cht der
KH-DRG</xs:documentati on>
              </xs:annotati on>
              <xs:simpl eType>
                <xs:restric ti on base="xs: deci mal ">
                  <xs:total Di gi ts val ue="8"/>
                  <xs:fracti onDi gi ts val ue="3"/>
                  <xs:maxExcl usi ve val ue="100000"/>
                </xs:restric ti on>
              </xs:simpl eType>
            </xs:attri bute>
          </xs:compl exType>
        </xs:el ement>
      <xs:el ement name="GKV_DRG" type="kh: DRG" mi nOccurs="0">
        <xs:annotati on>

```

```

        <xs:documentation>EKH08: GKV-DRG</xs:documentation>
    </xs:annotation>
</xs:element>
<xs:element name="Basisfallwert" minOccurs="0">
    <xs:annotation>
        <xs:documentation>EKH10: Basisfallwert</xs:documentation>
    </xs:annotation>
    <xs:simpleType>
        <xs:restriction base="xs:decimal">
            <xs:totalDigits value="7"/>
            <xs:fractionDigits value="2"/>
            <xs:maxExclusive value="100000"/>
        </xs:restriction>
    </xs:simpleType>
</xs:element>
</xs:sequence>
<xs:sequence>
    <xs:element name="Abgerechnete_KH_PEPP" minOccurs="0">
        <xs:annotation>
            <xs:documentation>EKH15: Abgerechnete
KH-PEPP</xs:documentation>
        </xs:annotation>
        <xs:simpleType>
            <xs:restriction base="xs:string">
                <xs:maxLength value="5"/>
                <xs:minLength value="1"/>
            </xs:restriction>
        </xs:simpleType>
    </xs:element>
    <xs:element name="GKV_PEPP" minOccurs="0">
        <xs:annotation>
            <xs:documentation>EKH16: GKV-PEPP</xs:documentation>
        </xs:annotation>
        <xs:simpleType>
            <xs:restriction base="xs:string">
                <xs:maxLength value="5"/>
                <xs:minLength value="1"/>
            </xs:restriction>
        </xs:simpleType>
    </xs:element>
    <xs:element name="Bewertungsrelation" minOccurs="0">
        <xs:annotation>
            <xs:documentation>EKH17: Eff. Bewertungsrelation der
KH-PEPP</xs:documentation>
        </xs:annotation>
        <xs:simpleType>
            <xs:restriction base="xs:decimal">
                <xs:totalDigits value="8"/>
                <xs:fractionDigits value="4"/>
                <xs:maxExclusive value="10000"/>
            </xs:restriction>
        </xs:simpleType>
    </xs:element>
    <xs:element name="Basisentgeltwert" minOccurs="0">
        <xs:annotation>

```

```

        <xs: documentation>EKH18: Basi sentgel twert am
Aufnahmetag</xs: documentation>
        </xs: annotation>
        <xs: simpleType>
        <xs: restriction base="xs: decimal ">
        <xs: totalDigits value="7"/>
        <xs: fractionDigits value="2"/>
        <xs: maxExclusive value="100000"/>
        </xs: restriction>
        </xs: simpleType>
        </xs: element>
        <xs: element name="Basi sentgel twert_Entl as" minOccurs="0">
        <xs: annotation>
        <xs: documentation>EKH19: Basi sentgel twert am
Entlassungstag</xs: documentation>
        </xs: annotation>
        <xs: simpleType>
        <xs: restriction base="xs: decimal ">
        <xs: totalDigits value="7"/>
        <xs: fractionDigits value="2"/>
        <xs: maxExclusive value="100000"/>
        </xs: restriction>
        </xs: simpleType>
        </xs: element>
        <xs: element name="Basi sentgel twert_Entl as_Guel t"
type="md: Datum_Stp" minOccurs="0">
        <xs: annotation>
        <xs: documentation>EKH20: Basi sentgel twert am Entlassungstag
guel tig ab</xs: documentation>
        </xs: annotation>
        </xs: element>
        </xs: sequence>
        </xs: choice>
        </xs: sequence>
        <xs: attribute name="entl assungsdatum" type="md: Datum_Stp"
use="required">
        <xs: annotation>
        <xs: documentation>EKH01: Datum Krankenhaus Entlassung im Format
(JJJJ-MM-TT)</xs: documentation>
        </xs: annotation>
        </xs: attribute>
        <xs: attribute name="entl assungszeit" type="xs: time" use="required">
        <xs: annotation>
        <xs: documentation>EKH02: Uhrzeit Krankenhaus Entlassung im Format
(HH: MM: SS)</xs: documentation>
        </xs: annotation>
        </xs: attribute>
        <xs: attribute name="fachabtei lung" type="kh: Fachabtei lung"
use="required">
        <xs: annotation>
        <xs: documentation>EKH03: Fachabteilungs- schuessel der entlassenden
Abtei lung</xs: documentation>
        </xs: annotation>
        </xs: attribute>
        <xs: attribute name="abtei lungstyp" type="md: Abtei lungstyp_Stp"

```

```

use="optional">
  <xs:annotation>
    <xs:documentation>EKH04: Zusatzschlüssel
Abteilungstyp</xs:documentation>
  </xs:annotation>
</xs:attribute>
<xs:attribute name="entlassungsgrund" type="kh:Entlassungsgrund"
use="required">
  <xs:annotation>
    <xs:documentation>EKH05: Grund der
Entlassung/Verlegung</xs:documentation>
  </xs:annotation>
</xs:attribute>
</xs:complexType>
</xs:element>
<xs:element name="Verlegungen" minOccurs="0" maxOccurs="999">
  <xs:annotation>
    <xs:documentation>LKH-Sätze </xs:documentation>
  </xs:annotation>
<xs:complexType>
  <xs:attribute name="von" type="md:Datum_Stp" use="optional">
    <xs:annotation>
      <xs:documentation>LKH01: Datum Behandlung von im Format
(JJJJ-MM-TT)</xs:documentation>
    </xs:annotation>
  </xs:attribute>
  <xs:attribute name="bis" type="md:Datum_Stp" use="required">
    <xs:annotation>
      <xs:documentation>LKH02: Datum Behandlung bis/Verlegung am im Format
(JJJJ-MM-TT)</xs:documentation>
    </xs:annotation>
  </xs:attribute>
  <xs:attribute name="fachabteilung" type="kh:Fachabteilung"
use="required">
    <xs:annotation>
      <xs:documentation>LKH03: Fachabteilung</xs:documentation>
    </xs:annotation>
  </xs:attribute>
  <xs:attribute name="verlegungsgrund" type="kh:Entlassungsgrund"
use="required">
    <xs:annotation>
      <xs:documentation>LKH04: Entlassungs/
Verlegungsgrund</xs:documentation>
    </xs:annotation>
  </xs:attribute>
  <xs:attribute name="uhrzeit" type="xs:time" use="required">
    <xs:annotation>
      <xs:documentation>LKH05: Entlassungs-/Verlegungsurzeit im Format
(HH:MM:SS)</xs:documentation>
    </xs:annotation>
  </xs:attribute>
</xs:complexType>
</xs:element>
<xs:element name="Entgelte" minOccurs="0" maxOccurs="999">
  <xs:annotation>

```

```

        <xs: documentati on>ETG-Sätze </xs: documentati on>
    </xs: annotati on>
    <xs: compl exType>
        <xs: attri bute name="entgel tart" use="requi red">
            <xs: annotati on>
                <xs: documentati on>ETG01: Entgel tart</xs: documentati on>
            </xs: annotati on>
            <xs: si mpl eType>
                <xs: restri cti on base="kh: Entgel tart">
                    <xs: length val ue="8"/>
                </xs: restri cti on>
            </xs: si mpl eType>
        </xs: attri bute>
        <xs: attri bute name="bezei chnung" use="requi red">
            <xs: annotati on>
                <xs: documentati on>ETG02: Bezei chnung des Entgel ts
    </xs: documentati on>
            </xs: annotati on>
            <xs: si mpl eType>
                <xs: restri cti on base="kh: Bezei chnung_Entgel t"/>
            </xs: si mpl eType>
        </xs: attri bute>
        <xs: attri bute name="betrag" use="opti onal ">
            <xs: annotati on>
                <xs: documentati on>ETG03: Entgel tbetrag </xs: documentati on>
            </xs: annotati on>
            <xs: si mpl eType>
                <xs: restri cti on base="xs: deci mal ">
                    <xs: fracti onDi gi ts val ue="2" fi xed="fal se"/>
                    <xs: total Di gi ts val ue="9"/>
                    <xs: maxExcl usi ve val ue="100000000"/>
                </xs: restri cti on>
            </xs: si mpl eType>
        </xs: attri bute>
        <xs: attri bute name="abrechnung_von" type="md: Datum_Stp" use="opti onal ">
            <xs: annotati on>
                <xs: documentati on>ETG04: Entgel t Abrechnung von im
Format(JJJJ-MM-TT)</xs: documentati on>
            </xs: annotati on>
        </xs: attri bute>
        <xs: attri bute name="abrechnung_bi s" type="md: Datum_Stp" use="opti onal ">
            <xs: annotati on>
                <xs: documentati on>ETG05: Entgel t Abrechnung bi s im
Format(JJJJ-MM-TT)</xs: documentati on>
            </xs: annotati on>
        </xs: attri bute>
        <xs: attri bute name="entgel t_anzahl " type="kh: Anzahl _Tage3"
use="requi red">
            <xs: annotati on>
                <xs: documentati on>ETG06: Anzahl des
Entgel tschl üssel s</xs: documentati on>
            </xs: annotati on>
        </xs: attri bute>
        <xs: attri bute name="TOB" type="kh: Anzahl _Tage3" use="opti onal ">
            <xs: annotati on>

```

```

        <xs:documentation>ETG07: Tage ohne
Berechnung/Behandlung</xs:documentation>
      </xs:annotation>
    </xs:attribute>
    <xs:attribute name="kz_pruefung" use="optional">
      <xs:annotation>
        <xs:documentation>ETG08: Kennzeichen - Gesonderte Prüfung durch MD
gewünscht</xs:documentation>
      </xs:annotation>
      <xs:simpleType>
        <xs:restriction base="xs:string">
          <xs:length value="1"/>
          <xs:enumeration value="1"/>
        </xs:restriction>
      </xs:simpleType>
    </xs:attribute>
  </xs:complexType>
</xs:element>
<xs:element name="Aktenzeichen_anderer_Begutachtungsfall"
type="md:Aktenzeichen_anderer_Begutachtungsfall_Ctp" minOccurs="0" maxOccurs="9">
  <xs:annotation>
    <xs:documentation>AAB: Aktenzeichen anderer
Begutachtungsfall</xs:documentation>
  </xs:annotation>
</xs:element>
<xs:element name="Standorte" minOccurs="0" maxOccurs="99">
  <xs:annotation>
    <xs:documentation>STA-Sätze</xs:documentation>
  </xs:annotation>
  <xs:complexType>
    <xs:attribute name="standortnummer" use="required">
      <xs:annotation>
        <xs:documentation>STA01: Standortnummer</xs:documentation>
      </xs:annotation>
      <xs:simpleType>
        <xs:restriction base="xs:string">
          <xs:length value="9"/>
        </xs:restriction>
      </xs:simpleType>
    </xs:attribute>
    <xs:attribute name="ende_datum" type="md:Datum_Stp" use="required">
      <xs:annotation>
        <xs:documentation>STA02: Standort Ende im Format
(JJJJ-MM-TT)</xs:documentation>
      </xs:annotation>
    </xs:attribute>
    <xs:attribute name="ende_uhrzeit" type="xs:time" use="required">
      <xs:annotation>
        <xs:documentation>STA03: Standort Ende Uhrzeit im Format
(HH:MM:SS)</xs:documentation>
      </xs:annotation>
    </xs:attribute>
  </xs:complexType>
</xs:element>
</xs:sequence>

```



```
</xs:complexType>
</xs:element>
```

element Beauftragung/Auftrag/Infos/Leistungserbringer

<p>diagram</p>	
<p>namespace</p>	<p>http://www.aok-systems.de/xml-schema/mdk-kh-standard_V07.00</p>
<p>type</p>	<p>Leistungserbringer_Ctp</p>
<p>properties</p>	<p>content complex</p>
<p>children</p>	<p>IK Name Name_Geschaeft Adresse Kontakt</p>
<p>annotation</p>	<p>documentation SDL: Stammdaten Leistungserbringer</p>
<p>source</p>	<pre><xs:element name="Leistungserbringer" type="md:Leistungserbringer_Ctp"> <xs:annotation> <xs:documentation>SDL: Stammdaten Leistungserbringer</xs:documentation> </xs:annotation> </xs:element></pre>

element Beauftragung/Auftrag/Infos/Pruefgegenstaende

diagram													
namespace	http://www.aok-systems.de/xml-schema/mdk-kh-standard_V07.00												
type	CT_Pruefgegenstand												
properties	minOcc 0 maxOcc 1 content complex												
children	Pruefgegenstand												
identity constraints	<table border="1"> <thead> <tr> <th></th> <th>Name</th> <th>Refer</th> <th>Selector</th> <th>Field(s)</th> <th>Annotation</th> </tr> </thead> <tbody> <tr> <td>unique</td> <td>key_preufgegenstand</td> <td></td> <td>kh:Pruefgegenstand</td> <td>@pruefgegenstand</td> <td></td> </tr> </tbody> </table>		Name	Refer	Selector	Field(s)	Annotation	unique	key_preufgegenstand		kh:Pruefgegenstand	@pruefgegenstand	
	Name	Refer	Selector	Field(s)	Annotation								
unique	key_preufgegenstand		kh:Pruefgegenstand	@pruefgegenstand									
annotation	documentation PGS-Sätze: Prüfgegenstand												
source	<pre> <xs:element name="Pruefgegenstaende" type="kh:CT_Pruefgegenstand" minOccurs="0"> <xs:annotation> <xs:documentation>PGS-Sätze: Prüfgegenstand</xs:documentation> </xs:annotation> <xs:unique name="key_preufgegenstand"> <xs:selector xpath="kh:Pruefgegenstand"/> <xs:field xpath="@pruefgegenstand"/> </xs:unique> </xs:element> </pre>												

element Beauftragung/Auftrag/Infos/Falldaten

<p>diagram</p>	
<p>namespace</p>	<p>http://www.aok-systems.de/xml-schema/mdk-kh-standard_V07.00</p>
<p>properties</p>	<p>content complex</p>
<p>children</p>	<p>Aufnahme Entlassung Arztnummer IK_Stelle Stelle_Notfall Zahnarztnummer Gewicht Behandlungsart</p>
<p>annotation</p>	<p>documentation FKH-Satz</p>
<p>source</p>	<pre><xs:element name="Falldaten"> <xs:annotation> <xs:documentation>FKH-Satz</xs:documentation> </xs:annotation> <xs:complexType> <xs:sequence> <xs:element name="Aufnahme"> <xs:annotation> <xs:documentation>FKH01-05</xs:documentation> </xs:annotation> <xs:complexType> <xs:attribute name="tag" type="md:Datum_Stp" use="required"> <xs:annotation> <xs:documentation>FKH01: Datum Krankenhaus-Aufnahme im Format (JJJJ-MM-TT)</xs:documentation> </xs:annotation> </xs:attribute> </xs:complexType> </xs:element> </xs:sequence> </xs:complexType> </xs:element></pre>

```

</xs:attribute>
<xs:attribute name="uhrzeit" type="xs:time" use="required">
  <xs:annotation>
    <xs:documentation>FKH02: Uhrzeit Krankenhaus-Aufnahme im Format
(HH: MM: SS)</xs:documentation>
  </xs:annotation>
</xs:attribute>
<xs:attribute name="aufnahmegrund" use="required">
  <xs:annotation>
    <xs:documentation>FKH03: Aufnahmegrund </xs:documentation>
  </xs:annotation>
  <xs:simpleType>
    <xs:restriction base="kh:Aufnahmegrund"/>
  </xs:simpleType>
</xs:attribute>
<xs:attribute name="aufnahmeanlass" type="kh:Aufnahmeanlass"
use="required">
  <xs:annotation>
    <xs:documentation>FKH04: Aufnahmeanlass </xs:documentation>
  </xs:annotation>
</xs:attribute>
<xs:attribute name="fachabteilung" type="kh:Fachabteilung"
use="required">
  <xs:annotation>
    <xs:documentation>FKH05: Fachabteilung</xs:documentation>
  </xs:annotation>
</xs:attribute>
</xs:complexType>
</xs:element>
<xs:element name="Entlassung" type="md:Datum_Stp" minOccurs="0">
  <xs:annotation>
    <xs:documentation>FKH06: Voraussichtliches Entlassungsdatum im Format
(JJJJ-MM-TT)</xs:documentation>
  </xs:annotation>
</xs:element>
<xs:element name="Arztnummer" minOccurs="0">
  <xs:annotation>
    <xs:documentation>FKH07: Arzt-Nummer des einweisenden
Arztes</xs:documentation>
  </xs:annotation>
  <xs:simpleType>
    <xs:restriction base="kh:Arztnummer"/>
  </xs:simpleType>
</xs:element>
<xs:element name="IK_Stelle" type="kh:IK_Stelle" minOccurs="0">
  <xs:annotation>
    <xs:documentation>FKH08: IK der veranlassenden Stelle</xs:documentation>
  </xs:annotation>
</xs:element>
<xs:element name="Stelle_Notfall" type="kh:Name_Stelle_Notfall"
minOccurs="0">
  <xs:annotation>
    <xs:documentation>FKH09: Veranlassende Stelle bei
Notfallaufnahme</xs:documentation>
  </xs:annotation>

```

```

</xs:element>
<xs:element name="Zahnarztnummer" minOccurs="0">
  <xs:annotation>
    <xs:documentation>FKH10: Arzt-Nummer des einweisenden
Zahnarztes</xs:documentation>
  </xs:annotation>
  <xs:simpleType>
    <xs:restriction base="kh:Arztnummer"/>
  </xs:simpleType>
</xs:element>
<xs:element name="Gewicht" minOccurs="0">
  <xs:annotation>
    <xs:documentation>FKH11: Aufnahmegewicht in Gramm</xs:documentation>
  </xs:annotation>
  <xs:simpleType>
    <xs:restriction base="xs:int">
      <xs:minInclusive value="0"/>
      <xs:maxInclusive value="99999"/>
    </xs:restriction>
  </xs:simpleType>
</xs:element>
<xs:element name="Behandlungsart" type="kh:Behandlungsart" minOccurs="0">
  <xs:annotation>
    <xs:documentation>FKH14: Behandlungsart</xs:documentation>
  </xs:annotation>
</xs:element>
</xs:sequence>
</xs:complexType>
</xs:element>

```

element Beauftragung/Auftrag/Infos/Falldaten/Aufnahme

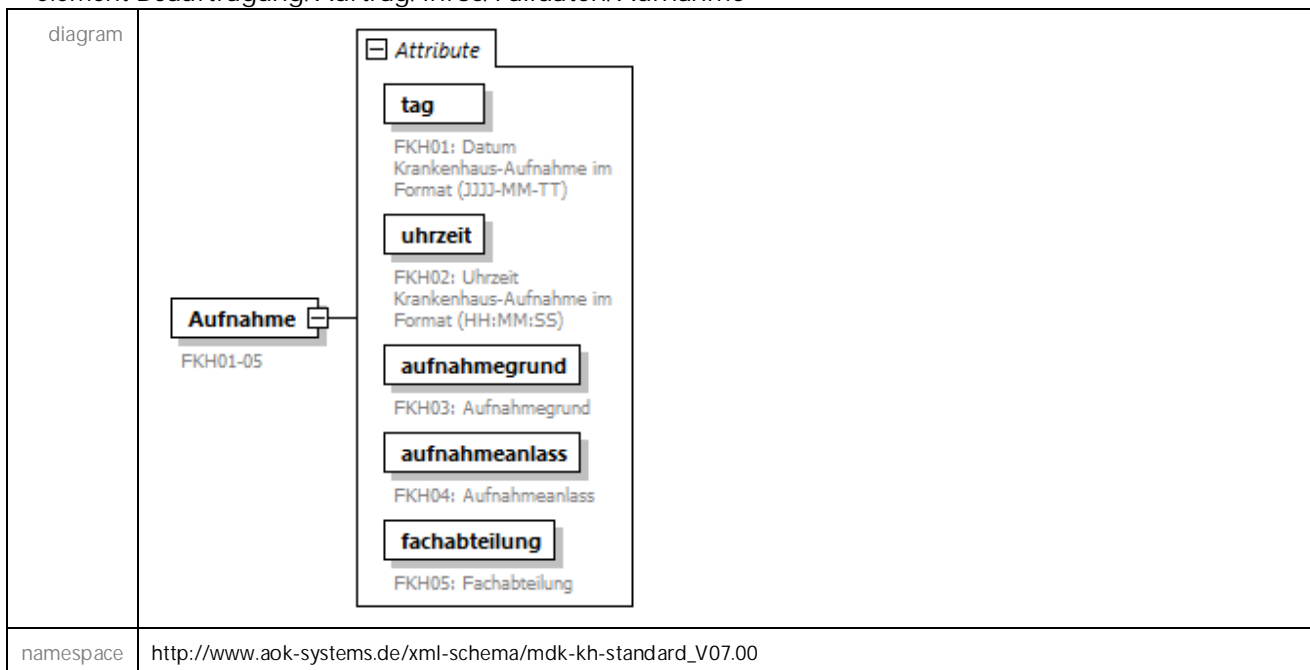

properties	content complex					
attributes	Name	Type	Use	Default	Fixed	Annotation
	tag	Datum_Stp	required			documentation FKH01: Datum Krankenhaus-Aufnahme im Format (JJJ-MM-TT)
	uhrzeit	xs:time	required			documentation FKH02: Uhrzeit Krankenhaus-Aufnahme im Format (HH:MM:SS)
	aufnahmegrund	derived by: Aufnahmegrund	required			documentation FKH03: Aufnahmegrund
	aufnahmeanlass	Aufnahmeanlass	required			documentation FKH04: Aufnahmeanlass
	fachabteilung	Fachabteilung	required			documentation FKH05: Fachabteilung
annotation	documentation FKH01-05					
source	<pre> <xs:element name="Aufnahme"> <xs:annotation> <xs:documentation>FKH01-05</xs:documentation> </xs:annotation> <xs:complexType> <xs:attribute name="tag" type="md: Datum_Stp" use="required"> <xs:annotation> <xs:documentation>FKH01: Datum Krankenhaus-Aufnahme im Format (JJJJ-MM-TT)</xs:documentation> </xs:annotation> </xs:attribute> <xs:attribute name="uhrzeit" type="xs:time" use="required"> <xs:annotation> <xs:documentation>FKH02: Uhrzeit Krankenhaus-Aufnahme im Format (HH:MM:SS)</xs:documentation> </xs:annotation> </xs:attribute> <xs:attribute name="aufnahmegrund" use="required"> <xs:annotation> <xs:documentation>FKH03: Aufnahmegrund </xs:documentation> </xs:annotation> <xs:simpleType> <xs:restriction base="kh: Aufnahmegrund"/> </xs:simpleType> </xs:attribute> <xs:attribute name="aufnahmeanlass" type="kh: Aufnahmeanlass" use="required"> <xs:annotation> <xs:documentation>FKH04: Aufnahmeanlass </xs:documentation> </xs:annotation> </xs:attribute> <xs:attribute name="fachabteilung" type="kh: Fachabteilung" use="required"> <xs:annotation> <xs:documentation>FKH05: Fachabteilung</xs:documentation> </xs:annotation> </xs:attribute> </xs:complexType> </xs:element> </pre>					

attribute Beauftragung/Auftrag/Infos/Falldaten/Aufnahme/@tag

type	Datum_Stp									
properties	use required									
facets	<table border="1"> <thead> <tr> <th>Kind</th> <th>Value</th> <th>Annotation</th> </tr> </thead> <tbody> <tr> <td>minInclusive</td> <td>1850-01-01</td> <td></td> </tr> <tr> <td>maxInclusive</td> <td>2099-12-31</td> <td></td> </tr> </tbody> </table>	Kind	Value	Annotation	minInclusive	1850-01-01		maxInclusive	2099-12-31	
Kind	Value	Annotation								
minInclusive	1850-01-01									
maxInclusive	2099-12-31									
annotation	documentation FKH01: Datum Krankenhaus-Aufnahme im Format (JJJJ-MM-TT)									
source	<pre><xs:attribute name="tag" type="md: Datum_Stp" use="required"> <xs:annotation> <xs:documentation>FKH01: Datum Krankenhaus-Aufnahme im Format (JJJJ-MM-TT)</xs:documentation> </xs:annotation> </xs:attribute></pre>									

attribute Beauftragung/Auftrag/Infos/Falldaten/Aufnahme/@uhrzeit

type	xs:time
properties	use required
annotation	documentation FKH02: Uhrzeit Krankenhaus-Aufnahme im Format (HH:MM:SS)
source	<pre><xs:attribute name="uhrzeit" type="xs:time" use="required"> <xs:annotation> <xs:documentation>FKH02: Uhrzeit Krankenhaus-Aufnahme im Format (HH:MM:SS)</xs:documentation> </xs:annotation> </xs:attribute></pre>

attribute Beauftragung/Auftrag/Infos/Falldaten/Aufnahme/@aufnahmegrund

type	restriction of Aufnahmegrund									
properties	use required									
facets	<table border="1"> <thead> <tr> <th>Kind</th> <th>Value</th> <th>Annotation</th> </tr> </thead> <tbody> <tr> <td>length</td> <td>4</td> <td></td> </tr> <tr> <td>pattern</td> <td>(0[1-9] 10 11)[024][1-8]</td> <td></td> </tr> </tbody> </table>	Kind	Value	Annotation	length	4		pattern	(0[1-9] 10 11)[024][1-8]	
Kind	Value	Annotation								
length	4									
pattern	(0[1-9] 10 11)[024][1-8]									
annotation	documentation FKH03: Aufnahmegrund									
source	<pre><xs:attribute name="aufnahmegrund" use="required"> <xs:annotation> <xs:documentation>FKH03: Aufnahmegrund </xs:documentation> </xs:annotation> <xs:simpleType> <xs:restriction base="kh: Aufnahmegrund" /> </xs:simpleType> </xs:attribute></pre>									

attribute Beauftragung/Auftrag/Infos/Falldaten/Aufnahme/@aufnahmeanlass

type	Aufnahmeanlass																					
properties	use required																					
facets	<table border="1"> <thead> <tr> <th>Kind</th> <th>Value</th> <th>Annotation</th> </tr> </thead> <tbody> <tr> <td>enumeration</td> <td>E</td> <td></td> </tr> <tr> <td>enumeration</td> <td>Z</td> <td></td> </tr> <tr> <td>enumeration</td> <td>N</td> <td></td> </tr> <tr> <td>enumeration</td> <td>R</td> <td></td> </tr> <tr> <td>enumeration</td> <td>V</td> <td></td> </tr> <tr> <td>enumeration</td> <td>A</td> <td></td> </tr> </tbody> </table>	Kind	Value	Annotation	enumeration	E		enumeration	Z		enumeration	N		enumeration	R		enumeration	V		enumeration	A	
Kind	Value	Annotation																				
enumeration	E																					
enumeration	Z																					
enumeration	N																					
enumeration	R																					
enumeration	V																					
enumeration	A																					
annotation	documentation FKH04: Aufnahmeanlass																					
source	<pre><xs:attribute name="aufnahmeanl ass" type="kh: Aufnahmeanl ass" use="requi red"> <xs:annotati on> <xs:documentati on>FKH04: Aufnahmeanl ass </xs:documentati on> </xs:annotati on> </xs:attri bute></pre>																					

attribute Beauftragung/Auftrag/Infos/Falldaten/Aufnahme/@fachabteilung

type	Fachabteilung									
properties	use required									
facets	<table border="1"> <thead> <tr> <th>Kind</th> <th>Value</th> <th>Annotation</th> </tr> </thead> <tbody> <tr> <td>length</td> <td>4</td> <td></td> </tr> <tr> <td>pattern</td> <td>[0-9]{4}</td> <td></td> </tr> </tbody> </table>	Kind	Value	Annotation	length	4		pattern	[0-9]{4}	
Kind	Value	Annotation								
length	4									
pattern	[0-9]{4}									
annotation	documentation FKH05: Fachabteilung									
source	<pre><xs:attribute name="fachabtei l ung" type="kh: Fachabtei l ung" use="requi red"> <xs:annotati on> <xs:documentati on>FKH05: Fachabtei l ung</xs:documentati on> </xs:annotati on> </xs:attri bute></pre>									

element Beauftragung/Auftrag/Infos/Falldaten/Entlassung

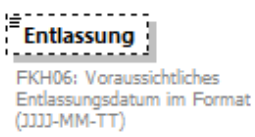
diagram							
namespace	http://www.aok-systems.de/xml-schema/mdk-kh-standard_V07.00						
type	Datum_Stp						
properties	<table border="1"> <tr> <td>minOcc</td> <td>0</td> </tr> <tr> <td>maxOcc</td> <td>1</td> </tr> <tr> <td>content</td> <td>simple</td> </tr> </table>	minOcc	0	maxOcc	1	content	simple
minOcc	0						
maxOcc	1						
content	simple						

facets	<table border="1"> <thead> <tr> <th>Kind</th> <th>Value</th> <th>Annotation</th> </tr> </thead> <tbody> <tr> <td>minInclusive</td> <td>1850-01-01</td> <td></td> </tr> <tr> <td>maxInclusive</td> <td>2099-12-31</td> <td></td> </tr> </tbody> </table>	Kind	Value	Annotation	minInclusive	1850-01-01		maxInclusive	2099-12-31	
Kind	Value	Annotation								
minInclusive	1850-01-01									
maxInclusive	2099-12-31									
annotation	documentation FKH06: Voraussichtliches Entlassungsdatum im Format (JJJJ-MM-TT)									
source	<pre><xs:element name="Entlassung" type="md: Datum_Stp" minOccurs="0"> <xs:annotation> <xs:documentation>FKH06: Voraussichtliches Entlassungsdatum im Format (JJJJ-MM-TT)</xs:documentation> </xs:annotation> </xs:element></pre>									

element Beauftragung/Auftrag/Infos/Falldaten/Arztnummer

diagram										
namespace	http://www.aok-systems.de/xml-schema/mdk-kh-standard_V07.00									
type	restriction of Arztnummer									
properties	minOcc 0 maxOcc 1 content simple									
facets	<table border="1"> <thead> <tr> <th>Kind</th> <th>Value</th> <th>Annotation</th> </tr> </thead> <tbody> <tr> <td>maxLength</td> <td>9</td> <td></td> </tr> <tr> <td>pattern</td> <td>[0-9]+</td> <td></td> </tr> </tbody> </table>	Kind	Value	Annotation	maxLength	9		pattern	[0-9]+	
Kind	Value	Annotation								
maxLength	9									
pattern	[0-9]+									
annotation	documentation FKH07: Arzt-Nummer des einweisenden Arztes									
source	<pre><xs:element name="Arztnummer" minOccurs="0"> <xs:annotation> <xs:documentation>FKH07: Arzt-Nummer des einweisenden Arztes</xs:documentation> </xs:annotation> <xs:simpleType> <xs:restriction base="kh: Arztnummer"/> </xs:simpleType> </xs:element></pre>									

element Beauftragung/Auftrag/Infos/Falldaten/IK_Stelle

diagram	
namespace	http://www.aok-systems.de/xml-schema/mdk-kh-standard_V07.00
type	IK_Stelle
properties	minOcc 0 maxOcc 1 content simple

facets	Kind Value Annotation length 9 pattern [0-9]{9}
annotation	documentation FKH08: IK der veranlassenden Stelle
source	<xs:element name="IK_Stelle" type="kh:IK_Stelle" minOccurs="0"> <xs:annotation> <xs:documentation>FKH08: IK der veranlassenden Stelle</xs:documentation> </xs:annotation> </xs:element>

element Beauftragung/Auftrag/Infos/Falldaten/Stelle_Notfall

diagram	 Stelle_Notfall FKH09: Veranlassende Stelle bei Notfallaufnahme
namespace	http://www.aok-systems.de/xml-schema/mdk-kh-standard_V07.00
type	Name_Stelle_Notfall
properties	minOcc 0 maxOcc 1 content simple
facets	Kind Value Annotation maxLength 30
annotation	documentation FKH09: Veranlassende Stelle bei Notfallaufnahme
source	<xs:element name="Stelle_Notfall" type="kh:Name_Stelle_Notfall" minOccurs="0"> <xs:annotation> <xs:documentation>FKH09: Veranlassende Stelle bei Notfallaufnahme</xs:documentation> </xs:annotation> </xs:element>

element Beauftragung/Auftrag/Infos/Falldaten/Zahnarztnummer

diagram	 Zahnarztnummer FKH10: Arzt-Nummer des einweisenden Zahnarztes
namespace	http://www.aok-systems.de/xml-schema/mdk-kh-standard_V07.00
type	restriction of Arztnummer
properties	minOcc 0 maxOcc 1 content simple
facets	Kind Value Annotation maxLength 9 pattern [0-9]+
annotation	documentation FKH10: Arzt-Nummer des einweisenden Zahnarztes

source	<pre> <xs:element name="Zahnarztnummer" minOccurs="0"> <xs:annotation> <xs:documentation>FKH10: Arzt-Nummer des einweisenden Zahnarztes</xs:documentation> </xs:annotation> <xs:simpleType> <xs:restriction base="kh:Arztnummer"/> </xs:simpleType> </xs:element> </pre>
--------	--

element Beauftragung/Auftrag/Infos/Falldaten/Gewicht

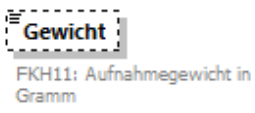
diagram										
namespace	http://www.aok-systems.de/xml-schema/mdk-kh-standard_V07.00									
type	restriction of xs:int									
properties	minOcc 0 maxOcc 1 content simple									
facets	<table border="1"> <thead> <tr> <th>Kind</th> <th>Value</th> <th>Annotation</th> </tr> </thead> <tbody> <tr> <td>minInclusive</td> <td>0</td> <td></td> </tr> <tr> <td>maxInclusive</td> <td>99999</td> <td></td> </tr> </tbody> </table>	Kind	Value	Annotation	minInclusive	0		maxInclusive	99999	
Kind	Value	Annotation								
minInclusive	0									
maxInclusive	99999									
annotation	documentation FKH11: Aufnahmegewicht in Gramm									
source	<pre> <xs:element name="Gewicht" minOccurs="0"> <xs:annotation> <xs:documentation>FKH11: Aufnahmegewicht in Gramm</xs:documentation> </xs:annotation> <xs:simpleType> <xs:restriction base="xs:int"> <xs:minInclusive value="0"/> <xs:maxInclusive value="99999"/> </xs:restriction> </xs:simpleType> </xs:element> </pre>									

element Beauftragung/Auftrag/Infos/Falldaten/Behandlungsart

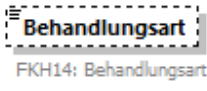
diagram	
namespace	http://www.aok-systems.de/xml-schema/mdk-kh-standard_V07.00
type	Behandlungsart
properties	minOcc 0 maxOcc 1 content simple

facets	<table border="1"> <thead> <tr> <th>Kind</th> <th>Value</th> <th>Annotation</th> </tr> </thead> <tbody> <tr><td>enumeration</td><td>1</td><td></td></tr> <tr><td>enumeration</td><td>2</td><td></td></tr> <tr><td>enumeration</td><td>3</td><td></td></tr> <tr><td>enumeration</td><td>4</td><td></td></tr> <tr><td>enumeration</td><td>5</td><td></td></tr> <tr><td>enumeration</td><td>6</td><td></td></tr> </tbody> </table>	Kind	Value	Annotation	enumeration	1		enumeration	2		enumeration	3		enumeration	4		enumeration	5		enumeration	6	
Kind	Value	Annotation																				
enumeration	1																					
enumeration	2																					
enumeration	3																					
enumeration	4																					
enumeration	5																					
enumeration	6																					
annotation	documentation FKH14: Behandlungsart																					
source	<pre><xs:element name="Behandlungsart" type="kh:Behandlungsart" minOccurs="0"> <xs:annotation> <xs:documentation>FKH14: Behandlungsart</xs:documentation> </xs:annotation> </xs:element></pre>																					

element Beauftragung/Auftrag/Infos/Verlaengerungen

diagram																			
namespace	http://www.aok-systems.de/xml-schema/mdk-kh-standard_V07.00																		
properties	minOcc 0 maxOcc 99 content complex																		
attributes	<table border="1"> <thead> <tr> <th>Name</th> <th>Type</th> <th>Use</th> <th>Default</th> <th>Fixed</th> <th>Annotation</th> </tr> </thead> <tbody> <tr> <td>aufnahme</td> <td>Datum_Stp</td> <td>required</td> <td></td> <td></td> <td>documentation VKH01: Datum der Aufnahme in Fachabteilung im Format (JJJJ-MM-TT)</td> </tr> <tr> <td>entlassung</td> <td>Datum_Stp</td> <td>required</td> <td></td> <td></td> <td>documentation VKH02: Voraussichtliches Entlassungsdatum im Format (JJJJ-MM-TT)</td> </tr> </tbody> </table>	Name	Type	Use	Default	Fixed	Annotation	aufnahme	Datum_Stp	required			documentation VKH01: Datum der Aufnahme in Fachabteilung im Format (JJJJ-MM-TT)	entlassung	Datum_Stp	required			documentation VKH02: Voraussichtliches Entlassungsdatum im Format (JJJJ-MM-TT)
Name	Type	Use	Default	Fixed	Annotation														
aufnahme	Datum_Stp	required			documentation VKH01: Datum der Aufnahme in Fachabteilung im Format (JJJJ-MM-TT)														
entlassung	Datum_Stp	required			documentation VKH02: Voraussichtliches Entlassungsdatum im Format (JJJJ-MM-TT)														
annotation	documentation VKH-Sätze																		
source	<pre><xs:element name="Verlaengerungen" minOccurs="0" maxOccurs="99"> <xs:annotation> <xs:documentation>VKH-Sätze</xs:documentation> </xs:annotation> <xs:complexType></pre>																		

	<pre> <xs:attribute name="aufnahme" type="md: Datum_Stp" use="required"> <xs:annotation> <xs:documentation>VKH01: Datum der Aufnahme in Fachabteilung im Format (JJJJ-MM-TT)</xs:documentation> </xs:annotation> </xs:attribute> <xs:attribute name="entlassung" type="md: Datum_Stp" use="required"> <xs:annotation> <xs:documentation>VKH02: Voraussichtliches Entlassungsdatum im Format (JJJJ-MM-TT)</xs:documentation> </xs:annotation> </xs:attribute> </xs:complexType> </xs:element> </pre>
--	---

attribute Beauftragung/Auftrag/Infos/Verlaengerungen/@aufnahme

type	Datum_Stp									
properties	use required									
facets	<table border="1"> <thead> <tr> <th>Kind</th> <th>Value</th> <th>Annotation</th> </tr> </thead> <tbody> <tr> <td>minInclusive</td> <td>1850-01-01</td> <td></td> </tr> <tr> <td>maxInclusive</td> <td>2099-12-31</td> <td></td> </tr> </tbody> </table>	Kind	Value	Annotation	minInclusive	1850-01-01		maxInclusive	2099-12-31	
Kind	Value	Annotation								
minInclusive	1850-01-01									
maxInclusive	2099-12-31									
annotation	documentation VKH01: Datum der Aufnahme in Fachabteilung im Format (JJJJ-MM-TT)									
source	<pre> <xs:attribute name="aufnahme" type="md: Datum_Stp" use="required"> <xs:annotation> <xs:documentation>VKH01: Datum der Aufnahme in Fachabteilung im Format (JJJJ-MM-TT)</xs:documentation> </xs:annotation> </xs:attribute> </pre>									

attribute Beauftragung/Auftrag/Infos/Verlaengerungen/@entlassung

type	Datum_Stp									
properties	use required									
facets	<table border="1"> <thead> <tr> <th>Kind</th> <th>Value</th> <th>Annotation</th> </tr> </thead> <tbody> <tr> <td>minInclusive</td> <td>1850-01-01</td> <td></td> </tr> <tr> <td>maxInclusive</td> <td>2099-12-31</td> <td></td> </tr> </tbody> </table>	Kind	Value	Annotation	minInclusive	1850-01-01		maxInclusive	2099-12-31	
Kind	Value	Annotation								
minInclusive	1850-01-01									
maxInclusive	2099-12-31									
annotation	documentation VKH02: Voraussichtliches Entlassungsdatum im Format (JJJJ-MM-TT)									
source	<pre> <xs:attribute name="entlassung" type="md: Datum_Stp" use="required"> <xs:annotation> <xs:documentation>VKH02: Voraussichtliches Entlassungsdatum im Format (JJJJ-MM-TT)</xs:documentation> </xs:annotation> </xs:attribute> </pre>									

element Beauftragung/Auftrag/Infos/Diagnosen

<p>diagram</p>													
<p>namespace</p>	<p>http://www.aok-systems.de/xml-schema/mdk-kh-standard_V07.00</p>												
<p>properties</p>	<p>content complex</p>												
<p>children</p>	<p>Diagnose</p>												
<p>attributes</p>	<table border="1"> <thead> <tr> <th>Name</th> <th>Type</th> <th>Use</th> <th>Default</th> <th>Fixed</th> <th>Annotation</th> </tr> </thead> <tbody> <tr> <td>icd_version</td> <td>derived by: xs:gYear</td> <td>required</td> <td></td> <td></td> <td>documentation FKH12: ICD-Version</td> </tr> </tbody> </table>	Name	Type	Use	Default	Fixed	Annotation	icd_version	derived by: xs:gYear	required			documentation FKH12: ICD-Version
Name	Type	Use	Default	Fixed	Annotation								
icd_version	derived by: xs:gYear	required			documentation FKH12: ICD-Version								
<p>annotation</p>	<p>documentation DIA-Satz und FKH12</p>												
<p>source</p>	<pre> <xs:element name="Diagnosen"> <xs:annotation> <xs:documentation>DIA-Satz und FKH12</xs:documentation> </xs:annotation> <xs:complexType> <xs:sequence> <xs:element name="Diagnose" maxOccurs="999"> <xs:annotation> <xs:documentation>DIA-Sätze </xs:documentation> </xs:annotation> <xs:complexType> <xs:attribute name="diagnosentyp" type="kh:Diagnosentyp" use="required"> <xs:annotation> <xs:documentation>DIA01: Diagnosentyp</xs:documentation> </xs:annotation> </xs:attribute> <xs:attribute name="icd" use="required"> <xs:annotation> <xs:documentation>DIA02: ICD-Schlüssel </xs:documentation> </xs:annotation> <xs:simpleType> <xs:restriction base="md:ICD_Schlüssel_Stp"> <xs:minLength value="3"/> </xs:restriction> </xs:simpleType> </xs:attribute> <xs:attribute name="lokalisation" type="md:Lokalisation_Stp" use="optional"> <xs:annotation> <xs:documentation>DIA03: Lokalisation</xs:documentation> </xs:annotation> </xs:attribute> <xs:attribute name="kz_pruefung" use="optional"> </pre>												

	<pre> <xs: annotation> <xs: documentation>DIA04: Kennzeichen - Gesonderte Prüfung durch MD gewünscht</xs: documentation> </xs: annotation> <xs: simpleType> <xs: restriction base="xs:string"> <xs:length value="1"/> <xs:enumeration value="1"/> </xs:restriction> </xs:simpleType> </xs:attribute> </xs:complexType> </xs:element> </xs:sequence> <xs:attribute name="icd_version" use="required"> <xs:annotation> <xs:documentation>FKH12: ICD-Version</xs:documentation> </xs:annotation> <xs:simpleType> <xs:restriction base="xs:gYear"> <xs:minInclusive value="2003"/> <xs:maxInclusive value="2099"/> </xs:restriction> </xs:simpleType> </xs:attribute> </xs:complexType> </xs:element> </pre>
--	--

attribute Beauftragung/Auftrag/Infos/Diagnosen/@icd_version

type	restriction of xs:gYear									
properties	use required									
facets	<table border="1"> <thead> <tr> <th>Kind</th> <th>Value</th> <th>Annotation</th> </tr> </thead> <tbody> <tr> <td>minInclusive</td> <td>2003</td> <td></td> </tr> <tr> <td>maxInclusive</td> <td>2099</td> <td></td> </tr> </tbody> </table>	Kind	Value	Annotation	minInclusive	2003		maxInclusive	2099	
Kind	Value	Annotation								
minInclusive	2003									
maxInclusive	2099									
annotation	documentation FKH12: ICD-Version									
source	<pre> <xs:attribute name="icd_version" use="required"> <xs:annotation> <xs:documentation>FKH12: ICD-Version</xs:documentation> </xs:annotation> <xs:simpleType> <xs:restriction base="xs:gYear"> <xs:minInclusive value="2003"/> <xs:maxInclusive value="2099"/> </xs:restriction> </xs:simpleType> </xs:attribute> </pre>									

element Beauftragung/Auftrag/Infos/Diagnosen/Diagnose

diagram							
namespace	http://www.aok-systems.de/xml-schema/mdk-kh-standard_V07.00						
properties	minOcc 1 maxOcc 999 content complex						
attributes	Name	Type	Use	Default	Fixed	Annotation	
	diagnosetyp	Diagnosentyp	required			documentation DIA01: Diagnosentyp	
	icd	derived by: ICD_Schluessel_Stp	required			documentation DIA02: ICD-Schlüssel	
	lokalisation	Lokalisation_Stp	optional			documentation DIA03: Lokalisation	
	kz_pruefung	derived by: xs:string	optional			documentation DIA04: Kennzeichen - Gesonderte Prüfung durch MD gewünscht	
annotation	documentation DIA-Sätze						
source	<pre> <xs:element name="Diagnose" maxOccurs="999"> <xs:annotation> <xs:documentation>DIA-Sätze </xs:documentation> </xs:annotation> <xs:complexType> <xs:attribute name="diagnosetyp" type="kh:Diagnosentyp" use="required"> <xs:annotation> <xs:documentation>DIA01: Diagnosentyp</xs:documentation> </xs:annotation> </xs:attribute> <xs:attribute name="icd" use="required"> <xs:annotation> <xs:documentation>DIA02: ICD-Schlüssel</xs:documentation> </xs:annotation> </xs:attribute> <xs:simpleType> <xs:restriction base="md:ICD_Schluessel_Stp"> </pre>						

	<pre> <xs: minLength value="3" /> </xs: restriction> </xs: simpleType> </xs: attribute> <xs: attribute name="Lokalisation" type="md:Lokalisation_Stp" use="optional"> <xs: annotation> <xs: documentation>DIA03: Lokalisation</xs: documentation> </xs: annotation> </xs: attribute> <xs: attribute name="kz_pruefung" use="optional"> <xs: annotation> <xs: documentation>DIA04: Kennzeichen - Gesonderte Prüfung durch MD gewünscht</xs: documentation> </xs: annotation> </xs: simpleType> <xs: restriction base="xs:string"> <xs: length value="1" /> <xs: enumeration value="1" /> </xs: restriction> </xs: simpleType> </xs: attribute> </xs: complexType> </xs: element> </pre>
--	--

attribute Beauftragung/Auftrag/Infos/Diagnosen/Diagnose/@diagnosetyp

type	Diagnosetyp															
properties	use required															
facets	<table border="1"> <thead> <tr> <th>Kind</th> <th>Value</th> <th>Annotation</th> </tr> </thead> <tbody> <tr> <td>enumeration</td> <td>01</td> <td></td> </tr> <tr> <td>enumeration</td> <td>02</td> <td></td> </tr> <tr> <td>enumeration</td> <td>03</td> <td></td> </tr> <tr> <td>enumeration</td> <td>04</td> <td></td> </tr> </tbody> </table>	Kind	Value	Annotation	enumeration	01		enumeration	02		enumeration	03		enumeration	04	
Kind	Value	Annotation														
enumeration	01															
enumeration	02															
enumeration	03															
enumeration	04															
annotation	documentation DIA01: Diagnosentyp															
source	<pre> <xs: attribute name="diagnosetyp" type="kh:Diagnosetyp" use="required"> <xs: annotation> <xs: documentation>DIA01: Diagnosentyp</xs: documentation> </xs: annotation> </xs: attribute> </pre>															

attribute Beauftragung/Auftrag/Infos/Diagnosen/Diagnose/@icd

type	restriction of ICD_Schluesel_Stp												
properties	use required												
facets	<table border="1"> <thead> <tr> <th>Kind</th> <th>Value</th> <th>Annotation</th> </tr> </thead> <tbody> <tr> <td>minLength</td> <td>3</td> <td></td> </tr> <tr> <td>maxLength</td> <td>9</td> <td></td> </tr> <tr> <td>pattern</td> <td>(\p{L}\p{N}\p{N}.)*?</td> <td></td> </tr> </tbody> </table>	Kind	Value	Annotation	minLength	3		maxLength	9		pattern	(\p{L}\p{N}\p{N}.)*?	
Kind	Value	Annotation											
minLength	3												
maxLength	9												
pattern	(\p{L}\p{N}\p{N}.)*?												

annotation	documentation DIA02: ICD-Schlüssel
source	<pre><xs:attribute name="icd" use="required"> <xs:annotation> <xs:documentation>DIA02: ICD-Schlüssel</xs:documentation> </xs:annotation> <xs:simpleType> <xs:restriction base="md:ICD_Schlüssel_Stp"> <xs:minLength value="3"/> </xs:restriction> </xs:simpleType> </xs:attribute></pre>

attribute Beauftragung/Auftrag/Infos/Diagnosen/Diagnose/@lokalisierung

type	Lokalisation_Stp												
properties	use optional												
facets	<table border="1"> <thead> <tr> <th>Kind</th> <th>Value</th> <th>Annotation</th> </tr> </thead> <tbody> <tr> <td>enumeration</td> <td>B</td> <td></td> </tr> <tr> <td>enumeration</td> <td>L</td> <td></td> </tr> <tr> <td>enumeration</td> <td>R</td> <td></td> </tr> </tbody> </table>	Kind	Value	Annotation	enumeration	B		enumeration	L		enumeration	R	
Kind	Value	Annotation											
enumeration	B												
enumeration	L												
enumeration	R												
annotation	documentation DIA03: Lokalisation												
source	<pre><xs:attribute name="lokalisierung" type="md:Lokalisation_Stp" use="optional"> <xs:annotation> <xs:documentation>DIA03: Lokalisierung</xs:documentation> </xs:annotation> </xs:attribute></pre>												

attribute Beauftragung/Auftrag/Infos/Diagnosen/Diagnose/@kz_pruefung

type	restriction of xs:string									
properties	use optional									
facets	<table border="1"> <thead> <tr> <th>Kind</th> <th>Value</th> <th>Annotation</th> </tr> </thead> <tbody> <tr> <td>length</td> <td>1</td> <td></td> </tr> <tr> <td>enumeration</td> <td>1</td> <td></td> </tr> </tbody> </table>	Kind	Value	Annotation	length	1		enumeration	1	
Kind	Value	Annotation								
length	1									
enumeration	1									
annotation	documentation DIA04: Kennzeichen - Gesonderte Prüfung durch MD gewünscht									
source	<pre><xs:attribute name="kz_pruefung" use="optional"> <xs:annotation> <xs:documentation>DIA04: Kennzeichen - Gesonderte Prüfung durch MD gewünscht</xs:documentation> </xs:annotation> <xs:simpleType> <xs:restriction base="xs:string"> <xs:length value="1"/> <xs:enumeration value="1"/> </xs:restriction> </xs:simpleType></pre>									

</xs:attribute>

element Beauftragung/Auftrag/Infos/Prozeduren

diagram													
namespace	http://www.aok-systems.de/xml-schema/mdk-kh-standard_V07.00												
properties	minOcc 0 maxOcc 1 content complex												
children	Prozedur												
attributes	<table border="1"><thead><tr><th>Name</th><th>Type</th><th>Use</th><th>Default</th><th>Fixed</th><th>Annotation</th></tr></thead><tbody><tr><td>ops_version</td><td>derived by: xs:gYear</td><td>required</td><td></td><td></td><td>documentation FKH13: OPS-Version</td></tr></tbody></table>	Name	Type	Use	Default	Fixed	Annotation	ops_version	derived by: xs:gYear	required			documentation FKH13: OPS-Version
Name	Type	Use	Default	Fixed	Annotation								
ops_version	derived by: xs:gYear	required			documentation FKH13: OPS-Version								
annotation	documentation OPS-Satz und FKH13												
source	<pre><xs:element name="Prozeduren" minOccurs="0"> <xs:annotation> <xs:documentation>OPS-Satz und FKH13</xs:documentation> </xs:annotation> <xs:complexType> <xs:sequence> <xs:element name="Prozedur" minOccurs="0" maxOccurs="999"> <xs:annotation> <xs:documentation>OPS Datensätze </xs:documentation> </xs:annotation> <xs:complexType> <xs:attribute name="ops" use="required"> <xs:annotation> <xs:documentation>OPS01: OPS-Schlüssel </xs:documentation> </xs:annotation> <xs:simpleType> <xs:restriction base="kh:OPS_Schlüssel"> <xs:minLength value="1"/> </xs:restriction> </xs:simpleType> </xs:attribute> <xs:attribute name="Lokalisation" type="md:Lokalisation_Stp" use="optional"> <xs:annotation> <xs:documentation>OPS02: Lokalisation</xs:documentation> </xs:annotation> </xs:attribute> <xs:attribute name="datum" type="md:Datum_Stp" use="optional"></pre>												

	<pre> <xs: annotation> <xs: documentation>OPS03: Datum OPS im Format (JJJJ-MM-TT)</xs: documentation> </xs: annotation> </xs: attribute> <xs: attribute name="kz_pruefung" use="optional"> <xs: annotation> <xs: documentation>OPS04: Kennzeichen - Gesonderte Prüfung durch MD gewünscht</xs: documentation> </xs: annotation> <xs: simpleType> <xs: restriction base="xs:string"> <xs:length value="1"/> <xs:enumeration value="1"/> </xs:restriction> </xs:simpleType> </xs:attribute> </xs:complexType> </xs:element> </xs:sequence> <xs:attribute name="ops_version" use="required"> <xs:annotation> <xs:documentation>FKH13: OPS-Version</xs:documentation> </xs:annotation> <xs:simpleType> <xs:restriction base="xs:gYear"> <xs:minInclusive value="2003"/> <xs:maxInclusive value="2099"/> </xs:restriction> </xs:simpleType> </xs:attribute> </xs:complexType> </xs:element> </pre>
--	---

attribute Beauftragung/Auftrag/Infos/Prozeduren/@ops_version

type	restriction of xs:gYear									
properties	use required									
facets	<table border="1"> <thead> <tr> <th>Kind</th> <th>Value</th> <th>Annotation</th> </tr> </thead> <tbody> <tr> <td>minInclusive</td> <td>2003</td> <td></td> </tr> <tr> <td>maxInclusive</td> <td>2099</td> <td></td> </tr> </tbody> </table>	Kind	Value	Annotation	minInclusive	2003		maxInclusive	2099	
Kind	Value	Annotation								
minInclusive	2003									
maxInclusive	2099									
annotation	documentation FKH13: OPS-Version									
source	<pre> <xs:attribute name="ops_version" use="required"> <xs:annotation> <xs:documentation>FKH13: OPS-Version</xs:documentation> </xs:annotation> <xs:simpleType> <xs:restriction base="xs:gYear"> <xs:minInclusive value="2003"/> <xs:maxInclusive value="2099"/> </xs:restriction> </pre>									

```
</xs:simpleType>
</xs:attribute>
```

element Beauftragung/Auftrag/Infos/Prozeduren/Prozedur

diagram																															
namespace	http://www.aok-systems.de/xml-schema/mdk-kh-standard_V07.00																														
properties	minOcc 0 maxOcc 999 content complex																														
attributes	<table border="1"> <thead> <tr> <th>Name</th> <th>Type</th> <th>Use</th> <th>Default</th> <th>Fixed</th> <th>Annotation</th> </tr> </thead> <tbody> <tr> <td>ops</td> <td>derived by: OPS_Schluessel</td> <td>required</td> <td></td> <td></td> <td>documentation OPS01: OPS-Schlüssel</td> </tr> <tr> <td>lokalisierung</td> <td>Lokalisation_Stp</td> <td>optional</td> <td></td> <td></td> <td>documentation OPS02: Lokalisation</td> </tr> <tr> <td>datum</td> <td>Datum_Stp</td> <td>optional</td> <td></td> <td></td> <td>documentation OPS03: Datum OPS im Format (JJJJ-MM-TT)</td> </tr> <tr> <td>kz_pruefung</td> <td>derived by: xs:string</td> <td>optional</td> <td></td> <td></td> <td>documentation OPS04: Kennzeichen - Gesonderte Prüfung durch MD gewünscht</td> </tr> </tbody> </table>	Name	Type	Use	Default	Fixed	Annotation	ops	derived by: OPS_Schluessel	required			documentation OPS01: OPS-Schlüssel	lokalisierung	Lokalisation_Stp	optional			documentation OPS02: Lokalisation	datum	Datum_Stp	optional			documentation OPS03: Datum OPS im Format (JJJJ-MM-TT)	kz_pruefung	derived by: xs:string	optional			documentation OPS04: Kennzeichen - Gesonderte Prüfung durch MD gewünscht
Name	Type	Use	Default	Fixed	Annotation																										
ops	derived by: OPS_Schluessel	required			documentation OPS01: OPS-Schlüssel																										
lokalisierung	Lokalisation_Stp	optional			documentation OPS02: Lokalisation																										
datum	Datum_Stp	optional			documentation OPS03: Datum OPS im Format (JJJJ-MM-TT)																										
kz_pruefung	derived by: xs:string	optional			documentation OPS04: Kennzeichen - Gesonderte Prüfung durch MD gewünscht																										
annotation	documentation OPS Datensätze																														
source	<pre><xs:element name="Prozedur" minOccurs="0" maxOccurs="999"> <xs:annotation> <xs:documentation>OPS Datensätze </xs:documentation> </xs:annotation> <xs:complexType> <xs:attribute name="ops" use="required"> <xs:annotation> <xs:documentation>OPS01: OPS-Schlüssel </xs:documentation> </xs:annotation> </xs:attribute> </xs:complexType> </xs:element></pre>																														

```

<xs:restriction base="kh: OPS_Schl uessel ">
  <xs:mi nLength val ue="1"/>
</xs:restriction>
</xs:sim pleType>
</xs:attri bute>
<xs:attri bute name="l okal i sati on" type="md: Lokal i sati on_Stp" use="opti onal ">
  <xs:annotati on>
    <xs:documentati on>OPS02: Lokal i sati on</xs:documentati on>
  </xs:annotati on>
</xs:attri bute>
<xs:attri bute name="datum" type="md: Datum_Stp" use="opti onal ">
  <xs:annotati on>
    <xs:documentati on>OPS03: Datum OPS im Format
(JJJJ-MM-TT)</xs:documentati on>
  </xs:annotati on>
</xs:attri bute>
<xs:attri bute name="kz_pruefung" use="opti onal ">
  <xs:annotati on>
    <xs:documentati on>OPS04: Kennzei chen - Gesonderte Prüfung durch MD
gewünscht</xs:documentati on>
  </xs:annotati on>
</xs:sim pleType>
  <xs:restriction base="xs: stri ng">
    <xs:l ength val ue="1"/>
    <xs:enumerati on val ue="1"/>
  </xs:restriction>
</xs:sim pleType>
</xs:attri bute>
</xs:compl exType>
</xs:el ement>

```

attribute Beauftragung/Auftrag/Infos/Prozeduren/Prozedur/@ops

type	restriction of OPS_Schl uessel									
properties	use required									
facets	<table border="1"> <thead> <tr> <th>Kind</th> <th>Value</th> <th>Annotation</th> </tr> </thead> <tbody> <tr> <td>minLength</td> <td>1</td> <td></td> </tr> <tr> <td>maxLength</td> <td>11</td> <td></td> </tr> </tbody> </table>	Kind	Value	Annotation	minLength	1		maxLength	11	
Kind	Value	Annotation								
minLength	1									
maxLength	11									
annotation	documentation OPS01: OPS-Schlüssel									
source	<pre> <xs:attri bute name="ops" use="requi red"> <xs:annotati on> <xs:documentati on>OPS01: OPS-Schl üssel </xs:documentati on> </xs:annotati on> </xs:sim pleType> <xs:restriction base="kh: OPS_Schl uessel "> <xs:mi nLength val ue="1"/> </xs:restriction> </xs:sim pleType> </xs:attri bute> </pre>									

attribute Beauftragung/Auftrag/Infos/Prozeduren/Prozedur/@lokalisierung

type	Lokalisierung_Stp												
properties	use optional												
facets	<table border="1"> <thead> <tr> <th>Kind</th> <th>Value</th> <th>Annotation</th> </tr> </thead> <tbody> <tr> <td>enumeration</td> <td>B</td> <td></td> </tr> <tr> <td>enumeration</td> <td>L</td> <td></td> </tr> <tr> <td>enumeration</td> <td>R</td> <td></td> </tr> </tbody> </table>	Kind	Value	Annotation	enumeration	B		enumeration	L		enumeration	R	
Kind	Value	Annotation											
enumeration	B												
enumeration	L												
enumeration	R												
annotation	documentation OPS02: Lokalisierung												
source	<pre><xs:attribute name="Lokalisierung" type="md:Lokalisierung_Stp" use="optional"> <xs:annotation> <xs:documentation>OPS02: Lokalisierung</xs:documentation> </xs:annotation> </xs:attribute></pre>												

attribute Beauftragung/Auftrag/Infos/Prozeduren/Prozedur/@datum

type	Datum_Stp									
properties	use optional									
facets	<table border="1"> <thead> <tr> <th>Kind</th> <th>Value</th> <th>Annotation</th> </tr> </thead> <tbody> <tr> <td>minInclusive</td> <td>1850-01-01</td> <td></td> </tr> <tr> <td>maxInclusive</td> <td>2099-12-31</td> <td></td> </tr> </tbody> </table>	Kind	Value	Annotation	minInclusive	1850-01-01		maxInclusive	2099-12-31	
Kind	Value	Annotation								
minInclusive	1850-01-01									
maxInclusive	2099-12-31									
annotation	documentation OPS03: Datum OPS im Format (JJJJ-MM-TT)									
source	<pre><xs:attribute name="datum" type="md:Datum_Stp" use="optional"> <xs:annotation> <xs:documentation>OPS03: Datum OPS im Format (JJJJ-MM-TT)</xs:documentation> </xs:annotation> </xs:attribute></pre>									

attribute Beauftragung/Auftrag/Infos/Prozeduren/Prozedur/@kz_pruefung

type	restriction of xs:string									
properties	use optional									
facets	<table border="1"> <thead> <tr> <th>Kind</th> <th>Value</th> <th>Annotation</th> </tr> </thead> <tbody> <tr> <td>length</td> <td>1</td> <td></td> </tr> <tr> <td>enumeration</td> <td>1</td> <td></td> </tr> </tbody> </table>	Kind	Value	Annotation	length	1		enumeration	1	
Kind	Value	Annotation								
length	1									
enumeration	1									
annotation	documentation OPS04: Kennzeichen - Gesonderte Prüfung durch MD gewünscht									
source	<pre><xs:attribute name="kz_pruefung" use="optional"> <xs:annotation> <xs:documentation>OPS04: Kennzeichen - Gesonderte Prüfung durch MD gewünscht</xs:documentation> </xs:annotation> <xs:simpleType> <xs:restriction base="xs:string"></pre>									

	<pre><xs:length value="1"/> <xs:enumeration value="1"/> </xs:restriction> </xs:simpleType> </xs:attribute></pre>
--	--

element Beauftragung/Auftrag/Infos/Entlassung

diagram

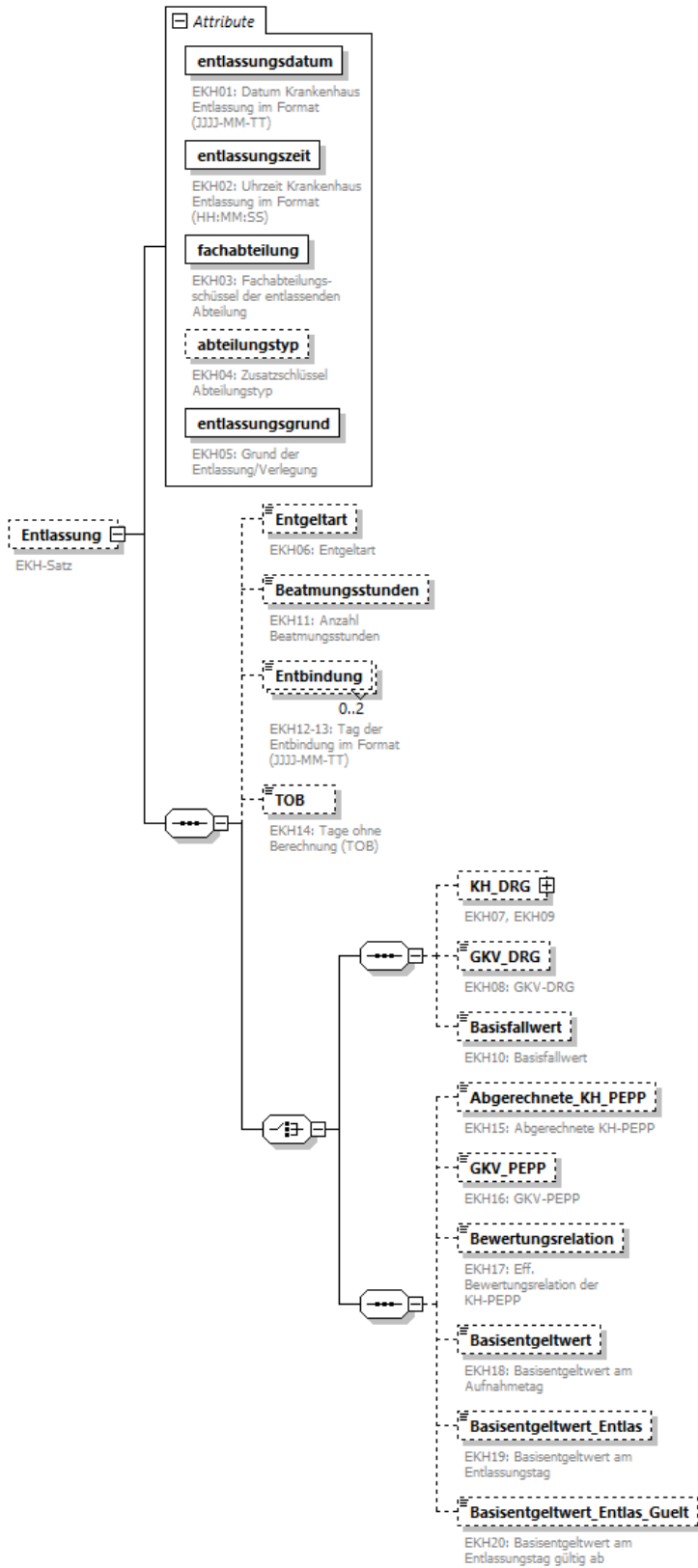

namespace	http://www.aok-systems.de/xml-schema/mdk-kh-standard_V07.00					
properties	minOcc 0 maxOcc 1 content complex					
children	Entgeltart Beatmungsstunden Entbindung TOB KH_DRG GKV_DRG Basisfallwert Abgerechnete KH PEPP GKV PEPP Bewertungsrelation Basisentgeltwert Basisentgeltwert Entlas Basisentgeltwert Entlas Guelt					
attributes	Name	Type	Use	Default	Fixed	Annotation
	entlassungsdatum	Datum Stp	required			documentation EKH01: Datum Krankenhaus Entlassung im Format (JJJ-MM-TT)
	entlassungszeit	xs:time	required			documentation EKH02: Uhrzeit Krankenhaus Entlassung im Format (HH:MM:SS)
	fachabteilung	Fachabteilung	required			documentation EKH03: Fachabteilungs- schlüssel der entlassenden Abteilung
	abteilungstyp	Abteilungstyp Stp	optional			documentation EKH04: Zusatzschlüssel Abteilungstyp
	entlassungsgrund	Entlassungsgrund	required			documentation EKH05: Grund der Entlassung/Verlegung
annotation	documentation EKH-Satz					
source	<pre> <xs:element name="Entlassung" minOccurs="0"> <xs:annotation> <xs:documentation>EKH-Satz</xs:documentation> </xs:annotation> <xs:complexType> <xs:sequence> <xs:element name="Entgeltart" type="kh:Entgeltart" minOccurs="0"> <xs:annotation> <xs:documentation>EKH06: Entgeltart</xs:documentation> </xs:annotation> </xs:element> <xs:element name="Beatmungsstunden" minOccurs="0"> <xs:annotation> <xs:documentation>EKH11: Anzahl Beatmungsstunden</xs:documentation> </xs:annotation> <xs:simpleType> <xs:restriction base="xs:int"> <xs:minInclusive value="0"/> <xs:maxInclusive value="9999"/> </xs:restriction> </xs:simpleType> </xs:element> <xs:element name="Entbindung" type="md:Datum_Stp" minOccurs="0" maxOccurs="2"> </pre>					

```

    <xs: annotation>
      <xs: documentation>EKH12-13: Tag der Entbindung im Format
(JJJJ-MM-TT)</xs: documentation>
    </xs: annotation>
  </xs: element>
  <xs: element name="TOB" type="kh: Anzahl_Tage3" minOccurs="0">
    <xs: annotation>
      <xs: documentation>EKH14: Tage ohne Berechnung (TOB)</xs: documentation>
    </xs: annotation>
  </xs: element>
  <xs: choice>
    <xs: sequence>
      <xs: element name="KH_DRG" minOccurs="0">
        <xs: annotation>
          <xs: documentation>EKH07, EKH09</xs: documentation>
        </xs: annotation>
        <xs: complexType>
          <xs: attribute name="DRG" use="optional ">
            <xs: annotation>
              <xs: documentation>EKH07: Abgerechnete KH-DRG</xs: documentation>
            </xs: annotation>
            <xs: simpleType>
              <xs: restriction base="kh: DRG"/>
            </xs: simpleType>
          </xs: attribute>
          <xs: attribute name="relativgewicht" use="optional ">
            <xs: annotation>
              <xs: documentation>EKH09: Eff. Relativgewicht der
KH-DRG</xs: documentation>
            </xs: annotation>
            <xs: simpleType>
              <xs: restriction base="xs: decimal ">
                <xs: totalDigits value="8"/>
                <xs: fractionDigits value="3"/>
                <xs: maxExclusive value="100000"/>
              </xs: restriction>
            </xs: simpleType>
          </xs: attribute>
        </xs: complexType>
      </xs: element>
      <xs: element name="GKV_DRG" type="kh: DRG" minOccurs="0">
        <xs: annotation>
          <xs: documentation>EKH08: GKV-DRG</xs: documentation>
        </xs: annotation>
      </xs: element>
      <xs: element name="Basissfallwert" minOccurs="0">
        <xs: annotation>
          <xs: documentation>EKH10: Basissfallwert</xs: documentation>
        </xs: annotation>
        <xs: simpleType>
          <xs: restriction base="xs: decimal ">
            <xs: totalDigits value="7"/>
            <xs: fractionDigits value="2"/>
            <xs: maxExclusive value="100000"/>
          </xs: restriction>
        </xs: simpleType>
      </xs: element>
    </xs: sequence>
  </xs: choice>

```

```

    </xs: simpleType>
  </xs: element>
</xs: sequence>
<xs: sequence>
  <xs: element name="Abgerechnete_KH_PEPP" minOccurs="0">
    <xs: annotation>
      <xs: documentation>EKH15: Abgerechnete KH-PEPP</xs: documentation>
    </xs: annotation>
    <xs: simpleType>
      <xs: restriction base="xs:string">
        <xs: maxLength value="5"/>
        <xs: minLength value="1"/>
      </xs: restriction>
    </xs: simpleType>
  </xs: element>
  <xs: element name="GKV_PEPP" minOccurs="0">
    <xs: annotation>
      <xs: documentation>EKH16: GKV-PEPP</xs: documentation>
    </xs: annotation>
    <xs: simpleType>
      <xs: restriction base="xs:string">
        <xs: maxLength value="5"/>
        <xs: minLength value="1"/>
      </xs: restriction>
    </xs: simpleType>
  </xs: element>
  <xs: element name="Bewertungsrelation" minOccurs="0">
    <xs: annotation>
      <xs: documentation>EKH17: Eff. Bewertungsrelation der
KH-PEPP</xs: documentation>
    </xs: annotation>
    <xs: simpleType>
      <xs: restriction base="xs:decimal">
        <xs: totalDigits value="8"/>
        <xs: fractionDigits value="4"/>
        <xs: maxExclusive value="10000"/>
      </xs: restriction>
    </xs: simpleType>
  </xs: element>
  <xs: element name="Basisentgeltwert" minOccurs="0">
    <xs: annotation>
      <xs: documentation>EKH18: Basisentgeltwert am
Aufnahmetag</xs: documentation>
    </xs: annotation>
    <xs: simpleType>
      <xs: restriction base="xs:decimal">
        <xs: totalDigits value="7"/>
        <xs: fractionDigits value="2"/>
        <xs: maxExclusive value="100000"/>
      </xs: restriction>
    </xs: simpleType>
  </xs: element>
  <xs: element name="Basisentgeltwert_Entlas" minOccurs="0">
    <xs: annotation>
      <xs: documentation>EKH19: Basisentgeltwert am

```

```

Entlassungstag</xs:documentation>
  </xs:annotation>
  <xs:simpleType>
    <xs:restriction base="xs:decimal">
      <xs:totalDigits value="7"/>
      <xs:fractionDigits value="2"/>
      <xs:maxExclusive value="100000"/>
    </xs:restriction>
  </xs:simpleType>
</xs:element>
<xs:element name="Basisentgeltwert_Entlassungstag" type="md:Datum_Stp"
minOccurs="0">
  <xs:annotation>
    <xs:documentation>EKH20: Basisentgeltwert am Entlassungstag gültig
ab</xs:documentation>
  </xs:annotation>
</xs:element>
</xs:sequence>
</xs:choice>
</xs:sequence>
<xs:attribute name="entlassungsdatum" type="md:Datum_Stp" use="required">
  <xs:annotation>
    <xs:documentation>EKH01: Datum Krankenhaus Entlassung im Format
(JJJJ-MM-TT)</xs:documentation>
  </xs:annotation>
</xs:attribute>
<xs:attribute name="entlassungszeit" type="xs:time" use="required">
  <xs:annotation>
    <xs:documentation>EKH02: Uhrzeit Krankenhaus Entlassung im Format
(HH:MM:SS)</xs:documentation>
  </xs:annotation>
</xs:attribute>
<xs:attribute name="fachabteilung" type="kh:Fachabteilung" use="required">
  <xs:annotation>
    <xs:documentation>EKH03: Fachabteilungs- schlüssel der entlassenden
Abteilung</xs:documentation>
  </xs:annotation>
</xs:attribute>
<xs:attribute name="abteilungstyp" type="md:Abteilungstyp_Stp"
use="optional">
  <xs:annotation>
    <xs:documentation>EKH04: Zusatzschlüssel Abteilungstyp</xs:documentation>
  </xs:annotation>
</xs:attribute>
<xs:attribute name="entlassungsgrund" type="kh:Entlassungsgrund"
use="required">
  <xs:annotation>
    <xs:documentation>EKH05: Grund der
Entlassung/Verlegung</xs:documentation>
  </xs:annotation>
</xs:attribute>
</xs:complexType>
</xs:element>

```

attribute Beauftragung/Auftrag/Infos/Entlassung/@entlassungsdatum

type	Datum_Stp									
properties	use required									
facets	<table border="1"> <thead> <tr> <th>Kind</th> <th>Value</th> <th>Annotation</th> </tr> </thead> <tbody> <tr> <td>minInclusive</td> <td>1850-01-01</td> <td></td> </tr> <tr> <td>maxInclusive</td> <td>2099-12-31</td> <td></td> </tr> </tbody> </table>	Kind	Value	Annotation	minInclusive	1850-01-01		maxInclusive	2099-12-31	
Kind	Value	Annotation								
minInclusive	1850-01-01									
maxInclusive	2099-12-31									
annotation	documentation EKH01: Datum Krankenhaus Entlassung im Format (JJJJ-MM-TT)									
source	<pre><xs:attribute name="entlassungsdatum" type="md: Datum_Stp" use="required"> <xs:annotation> <xs:documentation>EKH01: Datum Krankenhaus Entlassung im Format (JJJJ-MM-TT)</xs:documentation> </xs:annotation> </xs:attribute></pre>									

attribute Beauftragung/Auftrag/Infos/Entlassung/@entlassungszeit

type	xs:time
properties	use required
annotation	documentation EKH02: Uhrzeit Krankenhaus Entlassung im Format (HH:MM:SS)
source	<pre><xs:attribute name="entlassungszeit" type="xs:time" use="required"> <xs:annotation> <xs:documentation>EKH02: Uhrzeit Krankenhaus Entlassung im Format (HH:MM:SS)</xs:documentation> </xs:annotation> </xs:attribute></pre>

attribute Beauftragung/Auftrag/Infos/Entlassung/@fachabteilung

type	Fachabteilung									
properties	use required									
facets	<table border="1"> <thead> <tr> <th>Kind</th> <th>Value</th> <th>Annotation</th> </tr> </thead> <tbody> <tr> <td>length</td> <td>4</td> <td></td> </tr> <tr> <td>pattern</td> <td>[0-9]{4}</td> <td></td> </tr> </tbody> </table>	Kind	Value	Annotation	length	4		pattern	[0-9]{4}	
Kind	Value	Annotation								
length	4									
pattern	[0-9]{4}									
annotation	documentation EKH03: Fachabteilungs- schüssel der entlassenden Abteilung									
source	<pre><xs:attribute name="fachabteilung" type="kh: Fachabteilung" use="required"> <xs:annotation> <xs:documentation>EKH03: Fachabteilungs- schüssel der entlassenden Abteilung</xs:documentation> </xs:annotation> </xs:attribute></pre>									

attribute Beauftragung/Auftrag/Infos/Entlassung/@abteilungstyp

type	Abteilungstyp Stp																																																			
properties	use optional																																																			
facets	<table border="1"> <thead> <tr> <th>Kind</th> <th>Value</th> <th>Annotation</th> </tr> </thead> <tbody> <tr><td>enumeration</td><td>1</td><td></td></tr> <tr><td>enumeration</td><td>2</td><td></td></tr> <tr><td>enumeration</td><td>3</td><td></td></tr> <tr><td>enumeration</td><td>4</td><td></td></tr> <tr><td>enumeration</td><td>5</td><td></td></tr> <tr><td>enumeration</td><td>6</td><td></td></tr> <tr><td>enumeration</td><td>7</td><td></td></tr> <tr><td>enumeration</td><td>8</td><td></td></tr> <tr><td>enumeration</td><td>A</td><td></td></tr> <tr><td>enumeration</td><td>B</td><td></td></tr> <tr><td>enumeration</td><td>C</td><td></td></tr> <tr><td>enumeration</td><td>D</td><td></td></tr> <tr><td>enumeration</td><td>E</td><td></td></tr> <tr><td>enumeration</td><td>F</td><td></td></tr> <tr><td>enumeration</td><td>G</td><td></td></tr> <tr><td>enumeration</td><td>H</td><td></td></tr> </tbody> </table>	Kind	Value	Annotation	enumeration	1		enumeration	2		enumeration	3		enumeration	4		enumeration	5		enumeration	6		enumeration	7		enumeration	8		enumeration	A		enumeration	B		enumeration	C		enumeration	D		enumeration	E		enumeration	F		enumeration	G		enumeration	H	
Kind	Value	Annotation																																																		
enumeration	1																																																			
enumeration	2																																																			
enumeration	3																																																			
enumeration	4																																																			
enumeration	5																																																			
enumeration	6																																																			
enumeration	7																																																			
enumeration	8																																																			
enumeration	A																																																			
enumeration	B																																																			
enumeration	C																																																			
enumeration	D																																																			
enumeration	E																																																			
enumeration	F																																																			
enumeration	G																																																			
enumeration	H																																																			
annotation	documentation EKH04: Zusatzschlüssel Abteilungstyp																																																			
source	<pre><xs:attribute name="abteilungstyp" type="md:Abteilungstyp_Stp" use="optional"> <xs:annotation> <xs:documentation>EKH04: Zusatzschlüssel Abteilungstyp</xs:documentation> </xs:annotation> </xs:attribute></pre>																																																			

attribute Beauftragung/Auftrag/Infos/Entlassung/@entlassungsgrund

type	Entlassungsgrund									
properties	use required									
facets	<table border="1"> <thead> <tr> <th>Kind</th> <th>Value</th> <th>Annotation</th> </tr> </thead> <tbody> <tr><td>length</td><td>3</td><td></td></tr> <tr><td>pattern</td><td>[0-9]{3}</td><td></td></tr> </tbody> </table>	Kind	Value	Annotation	length	3		pattern	[0-9]{3}	
Kind	Value	Annotation								
length	3									
pattern	[0-9]{3}									
annotation	documentation EKH05: Grund der Entlassung/Verlegung									
source	<pre><xs:attribute name="entlassungsgrund" type="kh:Entlassungsgrund" use="required"> <xs:annotation> <xs:documentation>EKH05: Grund der Entlassung/Verlegung</xs:documentation> </xs:annotation> </xs:attribute></pre>									

element Beauftragung/Auftrag/Infos/Entlassung/Entgeltart

diagram	 EKH06: Entgeltart
namespace	http://www.aok-systems.de/xml-schema/mdk-kh-standard_V07.00
type	Entgeltart
properties	minOcc 0 maxOcc 1 content simple
facets	Kind Value Annotation length 8 pattern [0-9A-Z]{8}
annotation	documentation EKH06: Entgeltart
source	<pre><xs:element name="Entgeltart" type="kh:Entgeltart" minOccurs="0"> <xs:annotation> <xs:documentation>EKH06: Entgeltart</xs:documentation> </xs:annotation> </xs:element></pre>

element Beauftragung/Auftrag/Infos/Entlassung/Beatmungsstunden

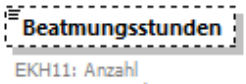
diagram	 EKH11: Anzahl Beatmungsstunden
namespace	http://www.aok-systems.de/xml-schema/mdk-kh-standard_V07.00
type	restriction of xs:int
properties	minOcc 0 maxOcc 1 content simple
facets	Kind Value Annotation minInclusive 0 maxInclusive 9999
annotation	documentation EKH11: Anzahl Beatmungsstunden
source	<pre><xs:element name="Beatmungsstunden" minOccurs="0"> <xs:annotation> <xs:documentation>EKH11: Anzahl Beatmungsstunden</xs:documentation> </xs:annotation> <xs:simpleType> <xs:restriction base="xs:int"> <xs:minInclusive value="0"/> <xs:maxInclusive value="9999"/> </xs:restriction> </xs:simpleType> </xs:element></pre>

element Beauftragung/Auftrag/Infos/Entlassung/Entbindung

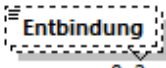
diagram	 <p>0..2 EKH12-13: Tag der Entbindung im Format (JJJJ-MM-TT)</p>									
namespace	http://www.aok-systems.de/xml-schema/mdk-kh-standard_V07.00									
type	Datum_Stp									
properties	minOcc 0 maxOcc 2 content simple									
facets	<table border="0"> <tr> <td>Kind</td> <td>Value</td> <td>Annotation</td> </tr> <tr> <td>minInclusive</td> <td>1850-01-01</td> <td></td> </tr> <tr> <td>maxInclusive</td> <td>2099-12-31</td> <td></td> </tr> </table>	Kind	Value	Annotation	minInclusive	1850-01-01		maxInclusive	2099-12-31	
Kind	Value	Annotation								
minInclusive	1850-01-01									
maxInclusive	2099-12-31									
annotation	documentation EKH12-13: Tag der Entbindung im Format (JJJJ-MM-TT)									
source	<pre><xs:element name="Entbindung" type="md: Datum_Stp" minOccurs="0" maxOccurs="2"> <xs:annotation> <xs:documentation>EKH12-13: Tag der Entbindung im Format (JJJJ-MM-TT)</xs:documentation> </xs:annotation> </xs:element></pre>									

element Beauftragung/Auftrag/Infos/Entlassung/TOB

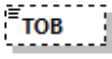
diagram	 <p>EKH14: Tage ohne Berechnung (TOB)</p>									
namespace	http://www.aok-systems.de/xml-schema/mdk-kh-standard_V07.00									
type	Anzahl_Tage3									
properties	minOcc 0 maxOcc 1 content simple									
facets	<table border="0"> <tr> <td>Kind</td> <td>Value</td> <td>Annotation</td> </tr> <tr> <td>minInclusive</td> <td>0</td> <td></td> </tr> <tr> <td>maxInclusive</td> <td>999</td> <td></td> </tr> </table>	Kind	Value	Annotation	minInclusive	0		maxInclusive	999	
Kind	Value	Annotation								
minInclusive	0									
maxInclusive	999									
annotation	documentation EKH14: Tage ohne Berechnung (TOB)									
source	<pre><xs:element name="TOB" type="kh: Anzahl_Tage3" minOccurs="0"> <xs:annotation> <xs:documentation>EKH14: Tage ohne Berechnung (TOB)</xs:documentation> </xs:annotation> </xs:element></pre>									

element Beauftragung/Auftrag/Infos/Entlassung/KH_DRG

diagram																			
namespace	http://www.aok-systems.de/xml-schema/mdk-kh-standard_V07.00																		
properties	minOcc 0 maxOcc 1 content complex																		
attributes	<table border="1"> <thead> <tr> <th>Name</th> <th>Type</th> <th>Use</th> <th>Default</th> <th>Fixed</th> <th>Annotation</th> </tr> </thead> <tbody> <tr> <td>DRG</td> <td>derived by: DRG</td> <td>optional</td> <td></td> <td></td> <td>documentation EKH07: Abgerechnete KH-DRG</td> </tr> <tr> <td>relativgewicht</td> <td>derived by: xs:decimal</td> <td>optional</td> <td></td> <td></td> <td>documentation EKH09: Eff. Relativgewicht der KH-DRG</td> </tr> </tbody> </table>	Name	Type	Use	Default	Fixed	Annotation	DRG	derived by: DRG	optional			documentation EKH07: Abgerechnete KH-DRG	relativgewicht	derived by: xs:decimal	optional			documentation EKH09: Eff. Relativgewicht der KH-DRG
Name	Type	Use	Default	Fixed	Annotation														
DRG	derived by: DRG	optional			documentation EKH07: Abgerechnete KH-DRG														
relativgewicht	derived by: xs:decimal	optional			documentation EKH09: Eff. Relativgewicht der KH-DRG														
annotation	documentation EKH07, EKH09																		
source	<pre> <xs:element name="KH_DRG" minOccurs="0"> <xs:annotation> <xs:documentation>EKH07, EKH09</xs:documentation> </xs:annotation> <xs:complexType> <xs:attribute name="DRG" use="optional"> <xs:annotation> <xs:documentation>EKH07: Abgerechnete KH-DRG</xs:documentation> </xs:annotation> <xs:simpleType> <xs:restriction base="kh:DRG"/> </xs:simpleType> </xs:attribute> <xs:attribute name="relativgewicht" use="optional"> <xs:annotation> <xs:documentation>EKH09: Eff. Relativgewicht der KH-DRG</xs:documentation> </xs:annotation> <xs:simpleType> <xs:restriction base="xs:decimal"> <xs:totalDigits value="8"/> <xs:fractionDigits value="3"/> <xs:maxExclusive value="100000"/> </xs:restriction> </xs:simpleType> </xs:attribute> </xs:complexType> </xs:element> </pre>																		

attribute Beauftragung/Auftrag/Infos/Entlassung/KH_DRG/@DRG

type	restriction of DRG						
properties	use optional						
facets	<table border="1"> <thead> <tr> <th>Kind</th> <th>Value</th> <th>Annotation</th> </tr> </thead> <tbody> <tr> <td>length</td> <td>4</td> <td></td> </tr> </tbody> </table>	Kind	Value	Annotation	length	4	
Kind	Value	Annotation					
length	4						
annotation	documentation EKH07: Abgerechnete KH-DRG						
source	<pre><xs:attribute name="DRG" use="optional"> <xs:annotation> <xs:documentation>EKH07: Abgerechnete KH-DRG</xs:documentation> </xs:annotation> <xs:simpleType> <xs:restriction base="kh:DRG"/> </xs:simpleType> </xs:attribute></pre>						

attribute Beauftragung/Auftrag/Infos/Entlassung/KH_DRG/@relativgewicht

type	restriction of xs:decimal												
properties	use optional												
facets	<table border="1"> <thead> <tr> <th>Kind</th> <th>Value</th> <th>Annotation</th> </tr> </thead> <tbody> <tr> <td>maxExclusive</td> <td>100000</td> <td></td> </tr> <tr> <td>totalDigits</td> <td>8</td> <td></td> </tr> <tr> <td>fractionDigits</td> <td>3</td> <td></td> </tr> </tbody> </table>	Kind	Value	Annotation	maxExclusive	100000		totalDigits	8		fractionDigits	3	
Kind	Value	Annotation											
maxExclusive	100000												
totalDigits	8												
fractionDigits	3												
annotation	documentation EKH09: Eff. Relativgewicht der KH-DRG												
source	<pre><xs:attribute name="relativgewicht" use="optional"> <xs:annotation> <xs:documentation>EKH09: Eff. Relativgewicht der KH-DRG</xs:documentation> </xs:annotation> <xs:simpleType> <xs:restriction base="xs:decimal"> <xs:totalDigits value="8"/> <xs:fractionDigits value="3"/> <xs:maxExclusive value="100000"/> </xs:restriction> </xs:simpleType> </xs:attribute></pre>												

element Beauftragung/Auftrag/Infos/Entlassung/GKV_DRG

diagram	
namespace	http://www.aok-systems.de/xml-schema/mdk-kh-standard_V07.00
type	DRG

properties	minOcc 0 maxOcc 1 content simple
facets	Kind Value Annotation length 4
annotation	documentation EKH08: GKV-DRG
source	<pre><xs:element name="GKV_DRG" type="kh:DRG" minOccurs="0"> <xs:annotation> <xs:documentation>EKH08: GKV-DRG</xs:documentation> </xs:annotation> </xs:element></pre>

element Beauftragung/Auftrag/Infos/Entlassung/Basisfallwert

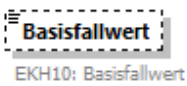
diagram	
namespace	http://www.aok-systems.de/xml-schema/mdk-kh-standard_V07.00
type	restriction of xs:decimal
properties	minOcc 0 maxOcc 1 content simple
facets	Kind Value Annotation maxExclusive 100000 totalDigits 7 fractionDigits 2
annotation	documentation EKH10: Basisfallwert
source	<pre><xs:element name="Basisfallwert" minOccurs="0"> <xs:annotation> <xs:documentation>EKH10: Basisfallwert</xs:documentation> </xs:annotation> <xs:simpleType> <xs:restriction base="xs:decimal"> <xs:totalDigits value="7"/> <xs:fractionDigits value="2"/> <xs:maxExclusive value="100000"/> </xs:restriction> </xs:simpleType> </xs:element></pre>

element Beauftragung/Auftrag/Infos/Entlassung/Abgerechnete_KH_PEPP

diagram	
namespace	http://www.aok-systems.de/xml-schema/mdk-kh-standard_V07.00

type	restriction of xs:string
properties	minOcc 0 maxOcc 1 content simple
facets	Kind Value Annotation minLength 1 maxLength 5
annotation	documentation EKH15: Abgerechnete KH-PEPP
source	<pre><xs:element name="Abgerechnete_KH_PEPP" minOccurs="0"> <xs:annotation> <xs:documentation>EKH15: Abgerechnete KH-PEPP</xs:documentation> </xs:annotation> <xs:simpleType> <xs:restriction base="xs:string"> <xs:maxLength value="5"/> <xs:minLength value="1"/> </xs:restriction> </xs:simpleType> </xs:element></pre>

element Beauftragung/Auftrag/Infos/Entlassung/GKV_PEPP

diagram	
namespace	http://www.aok-systems.de/xml-schema/mdk-kh-standard_V07.00
type	restriction of xs:string
properties	minOcc 0 maxOcc 1 content simple
facets	Kind Value Annotation minLength 1 maxLength 5
annotation	documentation EKH16: GKV-PEPP
source	<pre><xs:element name="GKV_PEPP" minOccurs="0"> <xs:annotation> <xs:documentation>EKH16: GKV-PEPP</xs:documentation> </xs:annotation> <xs:simpleType> <xs:restriction base="xs:string"> <xs:maxLength value="5"/> <xs:minLength value="1"/> </xs:restriction> </xs:simpleType> </xs:element></pre>

element Beauftragung/Auftrag/Infos/Entlassung/Bewertungsrelation

diagram													
namespace	http://www.aok-systems.de/xml-schema/mdk-kh-standard_V07.00												
type	restriction of xs:decimal												
properties	minOcc 0 maxOcc 1 content simple												
facets	<table border="1"> <thead> <tr> <th>Kind</th> <th>Value</th> <th>Annotation</th> </tr> </thead> <tbody> <tr> <td>maxExclusive</td> <td>10000</td> <td></td> </tr> <tr> <td>totalDigits</td> <td>8</td> <td></td> </tr> <tr> <td>fractionDigits</td> <td>4</td> <td></td> </tr> </tbody> </table>	Kind	Value	Annotation	maxExclusive	10000		totalDigits	8		fractionDigits	4	
Kind	Value	Annotation											
maxExclusive	10000												
totalDigits	8												
fractionDigits	4												
annotation	documentation EKH17: Eff. Bewertungsrelation der KH-PEPP												
source	<pre><xs:element name="Bewertungsrelation" minOccurs="0"> <xs:annotation> <xs:documentation>EKH17: Eff. Bewertungsrelation der KH-PEPP</xs:documentation> </xs:annotation> <xs:simpleType> <xs:restriction base="xs:decimal"> <xs:totalDigits value="8"/> <xs:fractionDigits value="4"/> <xs:maxExclusive value="10000"/> </xs:restriction> </xs:simpleType> </xs:element></pre>												

element Beauftragung/Auftrag/Infos/Entlassung/Basisentgeltwert

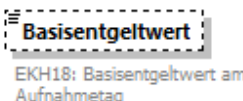
diagram													
namespace	http://www.aok-systems.de/xml-schema/mdk-kh-standard_V07.00												
type	restriction of xs:decimal												
properties	minOcc 0 maxOcc 1 content simple												
facets	<table border="1"> <thead> <tr> <th>Kind</th> <th>Value</th> <th>Annotation</th> </tr> </thead> <tbody> <tr> <td>maxExclusive</td> <td>100000</td> <td></td> </tr> <tr> <td>totalDigits</td> <td>7</td> <td></td> </tr> <tr> <td>fractionDigits</td> <td>2</td> <td></td> </tr> </tbody> </table>	Kind	Value	Annotation	maxExclusive	100000		totalDigits	7		fractionDigits	2	
Kind	Value	Annotation											
maxExclusive	100000												
totalDigits	7												
fractionDigits	2												
annotation	documentation EKH18: Basisentgeltwert am Aufnahmetag												
source	<pre><xs:element name="Basisentgeltwert" minOccurs="0"> <xs:annotation></pre>												

	<pre> <xs:documentation>EKH18: Basisentgeltwert am Aufnahmetag</xs:documentation> </xs:annotation> <xs:simpleType> <xs:restriction base="xs:decimal"> <xs:totalDigits value="7"/> <xs:fractionDigits value="2"/> <xs:maxExclusive value="100000"/> </xs:restriction> </xs:simpleType> </xs:element> </pre>
--	--

element Beauftragung/Auftrag/Infos/Entlassung/Basisentgeltwert_Entlas

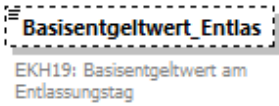
diagram													
namespace	http://www.aok-systems.de/xml-schema/mdk-kh-standard_V07.00												
type	restriction of xs:decimal												
properties	minOcc 0 maxOcc 1 content simple												
facets	<table border="1"> <thead> <tr> <th>Kind</th> <th>Value</th> <th>Annotation</th> </tr> </thead> <tbody> <tr> <td>maxExclusive</td> <td>100000</td> <td></td> </tr> <tr> <td>totalDigits</td> <td>7</td> <td></td> </tr> <tr> <td>fractionDigits</td> <td>2</td> <td></td> </tr> </tbody> </table>	Kind	Value	Annotation	maxExclusive	100000		totalDigits	7		fractionDigits	2	
Kind	Value	Annotation											
maxExclusive	100000												
totalDigits	7												
fractionDigits	2												
annotation	documentation EKH19: Basisentgeltwert am Entlassungstag												
source	<pre> <xs:element name="Basisentgeltwert_Entlas" minOccurs="0"> <xs:annotation> <xs:documentation>EKH19: Basisentgeltwert am Entlassungstag</xs:documentation> </xs:annotation> <xs:simpleType> <xs:restriction base="xs:decimal"> <xs:totalDigits value="7"/> <xs:fractionDigits value="2"/> <xs:maxExclusive value="100000"/> </xs:restriction> </xs:simpleType> </xs:element> </pre>												

element Beauftragung/Auftrag/Infos/Entlassung/Basisentgeltwert_Entlas_Guelt

diagram	
namespace	http://www.aok-systems.de/xml-schema/mdk-kh-standard_V07.00

type	Datum_Stp									
properties	minOcc 0 maxOcc 1 content simple									
facets	<table border="1"> <thead> <tr> <th>Kind</th> <th>Value</th> <th>Annotation</th> </tr> </thead> <tbody> <tr> <td>minInclusive</td> <td>1850-01-01</td> <td></td> </tr> <tr> <td>maxInclusive</td> <td>2099-12-31</td> <td></td> </tr> </tbody> </table>	Kind	Value	Annotation	minInclusive	1850-01-01		maxInclusive	2099-12-31	
Kind	Value	Annotation								
minInclusive	1850-01-01									
maxInclusive	2099-12-31									
annotation	documentation EKH20: Basisentgeltwert am Entlassungstag gültig ab									
source	<pre><xs:element name="Basisentgeltwert_Entlassungstag_gueltig_ab" type="md:Datum_Stp" minOccurs="0"> <xs:annotation> <xs:documentation>EKH20: Basisentgeltwert am Entlassungstag gültig ab</xs:documentation> </xs:annotation> </xs:element></pre>									

element Beauftragung/Auftrag/Infos/Verlegungen

diagram																			
namespace	http://www.aok-systems.de/xml-schema/mdk-kh-standard_V07.00																		
properties	minOcc 0 maxOcc 999 content complex																		
attributes	<table border="1"> <thead> <tr> <th>Name</th> <th>Type</th> <th>Use</th> <th>Default</th> <th>Fixed</th> <th>Annotation</th> </tr> </thead> <tbody> <tr> <td>von</td> <td>Datum_Stp</td> <td>optional</td> <td></td> <td></td> <td>documentation LKH01: Datum Behandlung von im Format (JJJJ-MM-TT)</td> </tr> <tr> <td>bis</td> <td>Datum_Stp</td> <td>required</td> <td></td> <td></td> <td>documentation LKH02: Datum Behandlung bis/Verlegung am im Format (JJJJ-MM-TT)</td> </tr> </tbody> </table>	Name	Type	Use	Default	Fixed	Annotation	von	Datum_Stp	optional			documentation LKH01: Datum Behandlung von im Format (JJJJ-MM-TT)	bis	Datum_Stp	required			documentation LKH02: Datum Behandlung bis/Verlegung am im Format (JJJJ-MM-TT)
Name	Type	Use	Default	Fixed	Annotation														
von	Datum_Stp	optional			documentation LKH01: Datum Behandlung von im Format (JJJJ-MM-TT)														
bis	Datum_Stp	required			documentation LKH02: Datum Behandlung bis/Verlegung am im Format (JJJJ-MM-TT)														

	<u>fachabteilung</u> <u>Fachabteilung</u> required <u>verlegungsgrund</u> <u>Entlassungsgrund</u> required <u>uhrzeit</u> xs:time required	documentation LKH03: Fachabteilung documentation LKH04: Entlassungs/ Verlegungsgrund documentation LKH05: Entlassungs-/Verlegungsuhrzeit im Format (HH:MM:SS)
annotation	documentation LKH-Sätze	
source	<pre> <xs:element name="Verlegungen" minOccurs="0" maxOccurs="999"> <xs:annotation> <xs:documentation>LKH-Sätze </xs:documentation> </xs:annotation> <xs:complexType> <xs:attribute name="von" type="md:Datum_Stp" use="optional"> <xs:annotation> <xs:documentation>LKH01: Datum Behandlung von im Format (JJJJ-MM-TT)</xs:documentation> </xs:annotation> </xs:attribute> <xs:attribute name="bis" type="md:Datum_Stp" use="required"> <xs:annotation> <xs:documentation>LKH02: Datum Behandlung bis/Verlegung am im Format (JJJJ-MM-TT)</xs:documentation> </xs:annotation> </xs:attribute> <xs:attribute name="fachabteilung" type="kh:Fachabteilung" use="required"> <xs:annotation> <xs:documentation>LKH03: Fachabteilung</xs:documentation> </xs:annotation> </xs:attribute> <xs:attribute name="verlegungsgrund" type="kh:Entlassungsgrund" use="required"> <xs:annotation> <xs:documentation>LKH04: Entlassungs/ Verlegungsgrund</xs:documentation> </xs:annotation> </xs:attribute> <xs:attribute name="uhrzeit" type="xs:time" use="required"> <xs:annotation> <xs:documentation>LKH05: Entlassungs-/Verlegungsuhrzeit im Format (HH:MM:SS)</xs:documentation> </xs:annotation> </xs:attribute> </xs:complexType> </xs:element> </pre>	

attribute Beauftragung/Auftrag/Infos/Verlegungen/@von

type	<u>Datum_Stp</u>
properties	use optional
facets	Kind Value Annotation

	minInclusive 1850-01-01 maxInclusive 2099-12-31
annotation	documentation LKH01: Datum Behandlung von im Format (JJJ-MM-TT)
source	<xs:attribute name="von" type="md: Datum_Stp" use="optional"> <xs:annotation> <xs:documentation>LKH01: Datum Behandlung von im Format (JJJ-MM-TT)</xs:documentation> </xs:annotation> </xs:attribute>

attribute Beauftragung/Auftrag/Infos/Verlegungen/@bis

type	Datum_Stp									
properties	use required									
facets	<table border="1"> <thead> <tr> <th>Kind</th> <th>Value</th> <th>Annotation</th> </tr> </thead> <tbody> <tr> <td>minInclusive</td> <td>1850-01-01</td> <td></td> </tr> <tr> <td>maxInclusive</td> <td>2099-12-31</td> <td></td> </tr> </tbody> </table>	Kind	Value	Annotation	minInclusive	1850-01-01		maxInclusive	2099-12-31	
Kind	Value	Annotation								
minInclusive	1850-01-01									
maxInclusive	2099-12-31									
annotation	documentation LKH02: Datum Behandlung bis/Verlegung am im Format (JJJ-MM-TT)									
source	<xs:attribute name="bis" type="md: Datum_Stp" use="required"> <xs:annotation> <xs:documentation>LKH02: Datum Behandlung bis/Verlegung am im Format (JJJ-MM-TT)</xs:documentation> </xs:annotation> </xs:attribute>									

attribute Beauftragung/Auftrag/Infos/Verlegungen/@fachabteilung

type	Fachabteilung									
properties	use required									
facets	<table border="1"> <thead> <tr> <th>Kind</th> <th>Value</th> <th>Annotation</th> </tr> </thead> <tbody> <tr> <td>length</td> <td>4</td> <td></td> </tr> <tr> <td>pattern</td> <td>[0-9]{4}</td> <td></td> </tr> </tbody> </table>	Kind	Value	Annotation	length	4		pattern	[0-9]{4}	
Kind	Value	Annotation								
length	4									
pattern	[0-9]{4}									
annotation	documentation LKH03: Fachabteilung									
source	<xs:attribute name="fachabteilung" type="kh: Fachabteilung" use="required"> <xs:annotation> <xs:documentation>LKH03: Fachabteilung</xs:documentation> </xs:annotation> </xs:attribute>									

attribute Beauftragung/Auftrag/Infos/Verlegungen/@verlegungsgrund

type	Entlassungsgrund
properties	use required

facets	Kind Value Annotation length 3 pattern [0-9]{3}
annotation	documentation LKH04: Entlassungs/ Verlegungsgrund
source	<xs:attribute name="verlegungsgrund" type="kh:Entlassungsgrund" use="required"> <xs:annotation> <xs:documentation>LKH04: Entlassungs/ Verlegungsgrund</xs:documentation> </xs:annotation> </xs:attribute>

attribute Beauftragung/Auftrag/Infos/Verlegungen/@uhrzeit

type	xs:time
properties	use required
annotation	documentation LKH05: Entlassungs-/Verlegungsuhrzeit im Format (HH:MM:SS)
source	<xs:attribute name="uhrzeit" type="xs:time" use="required"> <xs:annotation> <xs:documentation>LKH05: Entlassungs-/Verlegungsuhrzeit im Format (HH:MM:SS)</xs:documentation> </xs:annotation> </xs:attribute>

element Beauftragung/Auftrag/Infos/Entgelte

<p>diagram</p>	<p>Attributes</p> <ul style="list-style-type: none"> entgeltart ETG01: Entgeltart bezeichnung ETG02: Bezeichnung des Entgelts betrag ETG03: Entgeltbetrag abrechnung_von ETG04: Entgelt Abrechnung von im Format(JJJJ-MM-TT) abrechnung_bis ETG05: Entgelt Abrechnung bis im Format(JJJJ-MM-TT) entgelt_anzahl ETG06: Anzahl des Entgeltschlüssels TOB ETG07: Tage ohne Berechnung/Behandlung kz_pruefung ETG08: Kennzeichen - Gesonderte Prüfung durch MD gewünscht 					
<p>namespace</p>	<p>http://www.aok-systems.de/xml-schema/mdk-kh-standard_V07.00</p>					
<p>properties</p>	<p>minOcc 0 maxOcc 999 content complex</p>					
<p>attributes</p>	<p>Name</p> <p>entgeltart</p> <p>bezeichnung</p> <p>betrag</p> <p>abrechnung_von</p> <p>abrechnung_bis</p> <p>entgelt_anzahl</p> <p>TOB</p>	<p>Type</p> <p>derived by: Entgeltart</p> <p>derived by: Bezeichnung Entgelt</p> <p>derived by: xs:decimal Datum Stp</p> <p>Datum Stp</p> <p>Anzahl_Tage3</p> <p>Anzahl_Tage3</p>	<p>Use</p> <p>required</p> <p>required</p> <p>optional</p> <p>optional</p> <p>optional</p> <p>required</p> <p>optional</p>	<p>Default</p>	<p>Fixed</p>	<p>Annotation</p> <p>documentation ETG01: Entgeltart</p> <p>documentation ETG02: Bezeichnung des Entgelts</p> <p>documentation ETG03: Entgeltbetrag</p> <p>documentation ETG04: Entgelt Abrechnung von im Format(JJJJ-MM-TT)</p> <p>documentation ETG05: Entgelt Abrechnung bis im Format(JJJJ-MM-TT)</p> <p>documentation ETG06: Anzahl des Entgeltschlüssels</p> <p>documentation</p>

	kz_pruefung derived by: xs:string optional	ETG07: Tage ohne Berechnung/Behandlung documentation ETG08: Kennzeichen - Gesonderte Prüfung durch MD gewünscht
annotation	documentation ETG-Sätze	
source	<pre> <xs:element name="Entgelte" minOccurs="0" maxOccurs="999"> <xs:annotation> <xs:documentation>ETG-Sätze </xs:documentation> </xs:annotation> <xs:complexType> <xs:attribute name="entgeltart" use="required"> <xs:annotation> <xs:documentation>ETG01: Entgeltart</xs:documentation> </xs:annotation> <xs:simpleType> <xs:restriction base="kh:Entgeltart"> <xs:length value="8"/> </xs:restriction> </xs:simpleType> </xs:attribute> <xs:attribute name="bezeichnung" use="required"> <xs:annotation> <xs:documentation>ETG02: Bezeichnung des Entgelts </xs:documentation> </xs:annotation> <xs:simpleType> <xs:restriction base="kh:Bezeichnung_Entgelt"/> </xs:simpleType> </xs:attribute> <xs:attribute name="betrag" use="optional"> <xs:annotation> <xs:documentation>ETG03: Entgeltbetrag </xs:documentation> </xs:annotation> <xs:simpleType> <xs:restriction base="xs:decimal"> <xs:fractionDigits value="2" fixed="false"/> <xs:totalDigits value="9"/> <xs:maxExclusive value="100000000"/> </xs:restriction> </xs:simpleType> </xs:attribute> <xs:attribute name="abrechnung_von" type="md:Datum_Stp" use="optional"> <xs:annotation> <xs:documentation>ETG04: Entgelt Abrechnung von im Format(JJJJ-MM-TT)</xs:documentation> </xs:annotation> </xs:attribute> <xs:attribute name="abrechnung_bis" type="md:Datum_Stp" use="optional"> <xs:annotation> <xs:documentation>ETG05: Entgelt Abrechnung bis im Format(JJJJ-MM-TT)</xs:documentation> </xs:annotation> </xs:attribute> </xs:complexType> </pre>	

	<pre> <xs:attribute name="entgelt_anzahl" type="kh:Anzahl_Tage3" use="required"> <xs:annotation> <xs:documentation>ETG06: Anzahl des Entgeltschlüssels</xs:documentation> </xs:annotation> </xs:attribute> <xs:attribute name="TOB" type="kh:Anzahl_Tage3" use="optional"> <xs:annotation> <xs:documentation>ETG07: Tage ohne Berechnung/Behandlung</xs:documentation> </xs:annotation> </xs:attribute> <xs:attribute name="kz_pruefung" use="optional"> <xs:annotation> <xs:documentation>ETG08: Kennzeichen - Gesonderte Prüfung durch MD gewünscht</xs:documentation> </xs:annotation> <xs:simpleType> <xs:restriction base="xs:string"> <xs:length value="1"/> <xs:enumeration value="1"/> </xs:restriction> </xs:simpleType> </xs:attribute> </xs:complexType> </xs:element> </pre>
--	--

attribute Beauftragung/Auftrag/Infos/Entgelte/@entgeltart

type	restriction of Entgeltart									
properties	use required									
facets	<table border="1"> <thead> <tr> <th>Kind</th> <th>Value</th> <th>Annotation</th> </tr> </thead> <tbody> <tr> <td>length</td> <td>8</td> <td></td> </tr> <tr> <td>pattern</td> <td>[0-9A-Z]{8}</td> <td></td> </tr> </tbody> </table>	Kind	Value	Annotation	length	8		pattern	[0-9A-Z]{8}	
Kind	Value	Annotation								
length	8									
pattern	[0-9A-Z]{8}									
annotation	documentation ETG01: Entgeltart									
source	<pre> <xs:attribute name="entgeltart" use="required"> <xs:annotation> <xs:documentation>ETG01: Entgeltart</xs:documentation> </xs:annotation> <xs:simpleType> <xs:restriction base="kh:Entgeltart"> <xs:length value="8"/> </xs:restriction> </xs:simpleType> </xs:attribute> </pre>									

attribute Beauftragung/Auftrag/Infos/Entgelte/@bezeichnung

type	restriction of Bezeichnung_Entgelt
properties	use required

facets	<table border="1"> <thead> <tr> <th>Kind</th> <th>Value</th> <th>Annotation</th> </tr> </thead> <tbody> <tr> <td>minLength</td> <td>1</td> <td></td> </tr> <tr> <td>maxLength</td> <td>1024</td> <td></td> </tr> </tbody> </table>	Kind	Value	Annotation	minLength	1		maxLength	1024	
Kind	Value	Annotation								
minLength	1									
maxLength	1024									
annotation	documentation ETG02: Bezeichnung des Entgelts									
source	<pre><xs:attribute name="bezeichnung" use="required"> <xs:annotation> <xs:documentation>ETG02: Bezeichnung des Entgelts </xs:documentation> </xs:annotation> <xs:simpleType> <xs:restriction base="kh:Bezeichnung_Entgelt"/> </xs:simpleType> </xs:attribute></pre>									

attribute Beauftragung/Auftrag/Infos/Entgelte/@betrag

type	restriction of xs:decimal												
properties	use optional												
facets	<table border="1"> <thead> <tr> <th>Kind</th> <th>Value</th> <th>Annotation</th> </tr> </thead> <tbody> <tr> <td>maxExclusive</td> <td>100000000</td> <td></td> </tr> <tr> <td>totalDigits</td> <td>9</td> <td></td> </tr> <tr> <td>fractionDigits</td> <td>2</td> <td></td> </tr> </tbody> </table>	Kind	Value	Annotation	maxExclusive	100000000		totalDigits	9		fractionDigits	2	
Kind	Value	Annotation											
maxExclusive	100000000												
totalDigits	9												
fractionDigits	2												
annotation	documentation ETG03: Entgeltbetrag												
source	<pre><xs:attribute name="betrag" use="optional"> <xs:annotation> <xs:documentation>ETG03: Entgeltbetrag </xs:documentation> </xs:annotation> <xs:simpleType> <xs:restriction base="xs:decimal"> <xs:fractionDigits value="2" fixed="false"/> <xs:totalDigits value="9"/> <xs:maxExclusive value="100000000"/> </xs:restriction> </xs:simpleType> </xs:attribute></pre>												

attribute Beauftragung/Auftrag/Infos/Entgelte/@abrechnung_von

type	Datum_Stp									
properties	use optional									
facets	<table border="1"> <thead> <tr> <th>Kind</th> <th>Value</th> <th>Annotation</th> </tr> </thead> <tbody> <tr> <td>minInclusive</td> <td>1850-01-01</td> <td></td> </tr> <tr> <td>maxInclusive</td> <td>2099-12-31</td> <td></td> </tr> </tbody> </table>	Kind	Value	Annotation	minInclusive	1850-01-01		maxInclusive	2099-12-31	
Kind	Value	Annotation								
minInclusive	1850-01-01									
maxInclusive	2099-12-31									
annotation	documentation ETG04: Entgelt Abrechnung von im Format(JJJ-MM-TT)									
source	<pre><xs:attribute name="abrechnung_von" type="md:Datum_Stp" use="optional"> <xs:annotation> <xs:documentation>ETG04: Entgelt Abrechnung von im</pre>									

	Format(JJJJ-MM-TT)</xs:documentation> </xs:annotation> </xs:attribute>
--	--

attribute Beauftragung/Auftrag/Infos/Entgelte/@abrechnung_bis

type	Datum_Stp									
properties	use optional									
facets	<table border="1"> <thead> <tr> <th>Kind</th> <th>Value</th> <th>Annotation</th> </tr> </thead> <tbody> <tr> <td>minInclusive</td> <td>1850-01-01</td> <td></td> </tr> <tr> <td>maxInclusive</td> <td>2099-12-31</td> <td></td> </tr> </tbody> </table>	Kind	Value	Annotation	minInclusive	1850-01-01		maxInclusive	2099-12-31	
Kind	Value	Annotation								
minInclusive	1850-01-01									
maxInclusive	2099-12-31									
annotation	documentation ETG05: Entgelt Abrechnung bis im Format(JJJJ-MM-TT)									
source	<xs:attribute name="abrechnung_bis" type="md: Datum_Stp" use="optional"> <xs:annotation> <xs:documentation>ETG05: Entgelt Abrechnung bis im Format(JJJJ-MM-TT)</xs:documentation> </xs:annotation> </xs:attribute>									

attribute Beauftragung/Auftrag/Infos/Entgelte/@entgelt_anzahl

type	Anzahl_Tage3									
properties	use required									
facets	<table border="1"> <thead> <tr> <th>Kind</th> <th>Value</th> <th>Annotation</th> </tr> </thead> <tbody> <tr> <td>minInclusive</td> <td>0</td> <td></td> </tr> <tr> <td>maxInclusive</td> <td>999</td> <td></td> </tr> </tbody> </table>	Kind	Value	Annotation	minInclusive	0		maxInclusive	999	
Kind	Value	Annotation								
minInclusive	0									
maxInclusive	999									
annotation	documentation ETG06: Anzahl des Entgeltschlüssels									
source	<xs:attribute name="entgelt_anzahl" type="kh: Anzahl_Tage3" use="required"> <xs:annotation> <xs:documentation>ETG06: Anzahl des Entgeltschlüssels</xs:documentation> </xs:annotation> </xs:attribute>									

attribute Beauftragung/Auftrag/Infos/Entgelte/@TOB

type	Anzahl_Tage3									
properties	use optional									
facets	<table border="1"> <thead> <tr> <th>Kind</th> <th>Value</th> <th>Annotation</th> </tr> </thead> <tbody> <tr> <td>minInclusive</td> <td>0</td> <td></td> </tr> <tr> <td>maxInclusive</td> <td>999</td> <td></td> </tr> </tbody> </table>	Kind	Value	Annotation	minInclusive	0		maxInclusive	999	
Kind	Value	Annotation								
minInclusive	0									
maxInclusive	999									
annotation	documentation ETG07: Tage ohne Berechnung/Behandlung									
source	<xs:attribute name="TOB" type="kh: Anzahl_Tage3" use="optional"> <xs:annotation> <xs:documentation>ETG07: Tage ohne Berechnung/Behandlung</xs:documentation> </xs:annotation>									

	<pre></xs: annotation> </xs: attribute></pre>
--	---

attribute Beauftragung/Auftrag/Infos/Entgelte/@kz_pruefung

type	restriction of xs:string									
properties	use optional									
facets	<table border="1"> <thead> <tr> <th>Kind</th> <th>Value</th> <th>Annotation</th> </tr> </thead> <tbody> <tr> <td>length</td> <td>1</td> <td></td> </tr> <tr> <td>enumeration</td> <td>1</td> <td></td> </tr> </tbody> </table>	Kind	Value	Annotation	length	1		enumeration	1	
Kind	Value	Annotation								
length	1									
enumeration	1									
annotation	documentation ETG08: Kennzeichen - Gesonderte Prüfung durch MD gewünscht									
source	<pre><xs: attribute name="kz_pruefung" use="optional" > <xs: annotation> <xs: documentation>ETG08: Kennzeichen - Gesonderte Prüfung durch MD gewünscht</xs: documentation> </xs: annotation> <xs: simpleType> <xs: restriction base="xs:string"> <xs: length value="1"/> <xs: enumeration value="1"/> </xs: restriction> </xs: simpleType> </xs: attribute></pre>									

element Beauftragung/Auftrag/Infos/Aktenzeichen_anderer_Begutachtungsfall

diagram	
namespace	http://www.aok-systems.de/xml-schema/mdk-kh-standard_V07.00
type	Aktenzeichen_anderer_Begutachtungsfall_Ctp
properties	minOcc 0 maxOcc 9 content complex
children	Aktenzeichen Fallnummer
annotation	documentation AAB: Aktenzeichen anderer Begutachtungsfall
source	<pre><xs: element name="Aktenzeichen_anderer_Begutachtungsfall" type="md:Aktenzeichen_anderer_Begutachtungsfall_Ctp" minOccurs="0" maxOccurs="9"> <xs: annotation></pre>

```

<xs:documentation>AAB: Aktenzeichen anderer
Begutachtungsfall</xs:documentation>
</xs:annotation>
</xs:element>

```

element Beauftragung/Auftrag/Infos/Standorte

diagram																									
namespace	http://www.aok-systems.de/xml-schema/mdk-kh-standard_V07.00																								
properties	minOcc 0 maxOcc 99 content complex																								
attributes	<table border="1"> <thead> <tr> <th>Name</th> <th>Type</th> <th>Use</th> <th>Default</th> <th>Fixed</th> <th>Annotation</th> </tr> </thead> <tbody> <tr> <td>standortnummer</td> <td>derived by: xs:string</td> <td>required</td> <td></td> <td></td> <td>documentation STA01: Standortnummer</td> </tr> <tr> <td>ende_datum</td> <td>Datum_Stp</td> <td>required</td> <td></td> <td></td> <td>documentation STA02: Standort Ende im Format (JJJ-MM-TT)</td> </tr> <tr> <td>ende_uhrzeit</td> <td>xs:time</td> <td>required</td> <td></td> <td></td> <td>documentation STA03: Standort Ende Uhrzeit im Format (HH:MM:SS)</td> </tr> </tbody> </table>	Name	Type	Use	Default	Fixed	Annotation	standortnummer	derived by: xs:string	required			documentation STA01: Standortnummer	ende_datum	Datum_Stp	required			documentation STA02: Standort Ende im Format (JJJ-MM-TT)	ende_uhrzeit	xs:time	required			documentation STA03: Standort Ende Uhrzeit im Format (HH:MM:SS)
Name	Type	Use	Default	Fixed	Annotation																				
standortnummer	derived by: xs:string	required			documentation STA01: Standortnummer																				
ende_datum	Datum_Stp	required			documentation STA02: Standort Ende im Format (JJJ-MM-TT)																				
ende_uhrzeit	xs:time	required			documentation STA03: Standort Ende Uhrzeit im Format (HH:MM:SS)																				
annotation	documentation STA-Sätze																								
source	<pre> <xs:element name="Standorte" minOccurs="0" maxOccurs="99"> <xs:annotation> <xs:documentation>STA-Sätze</xs:documentation> </xs:annotation> <xs:complexType> <xs:attribute name="standortnummer" use="required"> <xs:annotation> <xs:documentation>STA01: Standortnummer</xs:documentation> </xs:annotation> <xs:simpleType> <xs:restriction base="xs:string"> <xs:length value="9"/> </xs:restriction> </xs:simpleType> </xs:attribute> </xs:complexType> </pre>																								

	<pre> <xs:attribute name="ende_datum" type="md: Datum_Stp" use="required"> <xs:annotation> <xs:documentation>STA02: Standort Ende im Format (JJJJ-MM-TT)</xs:documentation> </xs:annotation> </xs:attribute> <xs:attribute name="ende_uhrzeit" type="xs:time" use="required"> <xs:annotation> <xs:documentation>STA03: Standort Ende Uhrzeit im Format (HH:MM:SS)</xs:documentation> </xs:annotation> </xs:attribute> </xs:complexType> </xs:element> </pre>
--	--

attribute Beauftragung/Auftrag/Infos/Standorte/@standortnummer

type	restriction of xs:string						
properties	use required						
facets	<table border="1"> <thead> <tr> <th>Kind</th> <th>Value</th> <th>Annotation</th> </tr> </thead> <tbody> <tr> <td>length</td> <td>9</td> <td></td> </tr> </tbody> </table>	Kind	Value	Annotation	length	9	
Kind	Value	Annotation					
length	9						
annotation	documentation STA01: Standortnummer						
source	<pre> <xs:attribute name="standortnummer" use="required"> <xs:annotation> <xs:documentation>STA01: Standortnummer</xs:documentation> </xs:annotation> <xs:simpleType> <xs:restriction base="xs:string"> <xs:length value="9"/> </xs:restriction> </xs:simpleType> </xs:attribute> </pre>						

attribute Beauftragung/Auftrag/Infos/Standorte/@ende_datum

type	Datum_Stp									
properties	use required									
facets	<table border="1"> <thead> <tr> <th>Kind</th> <th>Value</th> <th>Annotation</th> </tr> </thead> <tbody> <tr> <td>minInclusive</td> <td>1850-01-01</td> <td></td> </tr> <tr> <td>maxInclusive</td> <td>2099-12-31</td> <td></td> </tr> </tbody> </table>	Kind	Value	Annotation	minInclusive	1850-01-01		maxInclusive	2099-12-31	
Kind	Value	Annotation								
minInclusive	1850-01-01									
maxInclusive	2099-12-31									
annotation	documentation STA02: Standort Ende im Format (JJJJ-MM-TT)									
source	<pre> <xs:attribute name="ende_datum" type="md: Datum_Stp" use="required"> <xs:annotation> <xs:documentation>STA02: Standort Ende im Format (JJJJ-MM-TT)</xs:documentation> </xs:annotation> </xs:attribute> </pre>									

attribute Beauftragung/Auftrag/Infos/Standorte/@ende_uhrzeit

type	xs:time
properties	use required
annotation	documentation STA03: Standort Ende Uhrzeit im Format (HH:MM:SS)
source	<pre><xs:attribute name="ende_uhrzeit" type="xs:time" use="required"> <xs:annotation> <xs:documentation>STA03: Standort Ende Uhrzeit im Format (HH: MM: SS)</xs:documentation> </xs:annotation> </xs:attribute></pre>

element Beauftragung/Storno

diagram																									
namespace	http://www.aok-systems.de/xml-schema/mdk-kh-standard_V07.00																								
properties	content complex																								
attributes	<table border="1"> <thead> <tr> <th>Name</th> <th>Type</th> <th>Use</th> <th>Default</th> <th>Fixed</th> <th>Annotation</th> </tr> </thead> <tbody> <tr> <td>auftragsart</td> <td>Auftragsart</td> <td>required</td> <td></td> <td></td> <td>documentation AST01: Auftragsart</td> </tr> <tr> <td>aktenzeichen</td> <td>Aktenzeichen_Stp</td> <td>required</td> <td></td> <td></td> <td>documentation AST02: Aktenzeichen der Krankenkasse</td> </tr> <tr> <td>erlaeuterung</td> <td>Freitext_1024</td> <td>optional</td> <td></td> <td></td> <td>documentation AST03: Erläuterungen</td> </tr> </tbody> </table>	Name	Type	Use	Default	Fixed	Annotation	auftragsart	Auftragsart	required			documentation AST01: Auftragsart	aktenzeichen	Aktenzeichen_Stp	required			documentation AST02: Aktenzeichen der Krankenkasse	erlaeuterung	Freitext_1024	optional			documentation AST03: Erläuterungen
Name	Type	Use	Default	Fixed	Annotation																				
auftragsart	Auftragsart	required			documentation AST01: Auftragsart																				
aktenzeichen	Aktenzeichen_Stp	required			documentation AST02: Aktenzeichen der Krankenkasse																				
erlaeuterung	Freitext_1024	optional			documentation AST03: Erläuterungen																				
annotation	documentation Stornierungsmeldung an MD																								
source	<pre><xs:element name="Storno"> <xs:annotation> <xs:documentation>Storni erungsmel dung an MD</xs:documentati on> </xs:annotati on> <xs:compl exType> <xs:attri bute name="auftragsart" type="kh:Auftragsart" use="requi red"> <xs:annotati on></pre>																								

	<pre> <xs:documentation>AST01: Auftragsart</xs:documentation> </xs:annotation> </xs:attribute> <xs:attribute name="aktenzeichen" type="md:Aktenzeichen_Stp" use="required"> <xs:annotation> <xs:documentation>AST02: Aktenzeichen der Krankenkasse</xs:documentation> </xs:annotation> </xs:attribute> <xs:attribute name="erlaeuterung" type="kh:Freitext_1024" use="optional"> <xs:annotation> <xs:documentation>AST03: Erläuterungen</xs:documentation> </xs:annotation> </xs:attribute> </xs:complexType> </xs:element> </pre>
--	--

attribute Beauftragung/Storno/@auftragsart

type	Auftragsart																																				
properties	use required																																				
facets	<table border="1"> <thead> <tr> <th>Kind</th> <th>Value</th> <th>Annotation</th> </tr> </thead> <tbody> <tr><td>enumeration</td><td>01</td><td></td></tr> <tr><td>enumeration</td><td>02</td><td></td></tr> <tr><td>enumeration</td><td>03</td><td></td></tr> <tr><td>enumeration</td><td>04</td><td></td></tr> <tr><td>enumeration</td><td>05</td><td></td></tr> <tr><td>enumeration</td><td>06</td><td></td></tr> <tr><td>enumeration</td><td>07</td><td></td></tr> <tr><td>enumeration</td><td>08</td><td></td></tr> <tr><td>enumeration</td><td>09</td><td></td></tr> <tr><td>enumeration</td><td>10</td><td></td></tr> <tr><td>enumeration</td><td>11</td><td></td></tr> </tbody> </table>	Kind	Value	Annotation	enumeration	01		enumeration	02		enumeration	03		enumeration	04		enumeration	05		enumeration	06		enumeration	07		enumeration	08		enumeration	09		enumeration	10		enumeration	11	
Kind	Value	Annotation																																			
enumeration	01																																				
enumeration	02																																				
enumeration	03																																				
enumeration	04																																				
enumeration	05																																				
enumeration	06																																				
enumeration	07																																				
enumeration	08																																				
enumeration	09																																				
enumeration	10																																				
enumeration	11																																				
annotation	documentation AST01: Auftragsart																																				
source	<pre> <xs:attribute name="auftragsart" type="kh:Auftragsart" use="required"> <xs:annotation> <xs:documentation>AST01: Auftragsart</xs:documentation> </xs:annotation> </xs:attribute> </pre>																																				

attribute Beauftragung/Storno/@aktenzeichen

type	Aktenzeichen_Stp												
properties	use required												
facets	<table border="1"> <thead> <tr> <th>Kind</th> <th>Value</th> <th>Annotation</th> </tr> </thead> <tbody> <tr><td>minLength</td><td>2</td><td></td></tr> <tr><td>maxLength</td><td>18</td><td></td></tr> <tr><td>pattern</td><td>\S+[#x0020;-&#x00FF;]*</td><td></td></tr> </tbody> </table>	Kind	Value	Annotation	minLength	2		maxLength	18		pattern	\S+[#x0020;-ÿ]*	
Kind	Value	Annotation											
minLength	2												
maxLength	18												
pattern	\S+[#x0020;-ÿ]*												

annotation	documentation AST02: Aktenzeichen der Krankenkasse
source	<xs:attribute name="aktenzeichen" type="md: Aktenzeichen_Stp" use="required"> <xs:annotation> <xs:documentation>AST02: Aktenzeichen der Krankenkasse</xs:documentation> </xs:annotation> </xs:attribute>

attribute Beauftragung/Storno/@erlaeuterung

type	Freitext_1024
properties	use optional
facets	Kind Value Annotation minLength 1 maxLength 1024
annotation	documentation AST03: Erläuterungen
source	<xs:attribute name="erlaeuterung" type="kh: Freitext_1024" use="optional"> <xs:annotation> <xs:documentation>AST03: Erläuterungen</xs:documentation> </xs:annotation> </xs:attribute>

element Beauftragung/Zwischennachricht_ZAP

diagram	
namespace	http://www.aok-systems.de/xml-schema/mdk-kh-standard_V07.00
properties	content complex
children	AZ_KK Datum_Antwort Antwort_Erweiterung_Pruefgegenstand
annotation	documentation Zwischennachricht Antwort Erweiterung des Prüfgegenstandes (ZAP) an MD
source	<xs:element name="Zwischennachricht_ZAP"> <xs:annotation> <xs:documentation>Zwischennachricht Antwort Erweiterung des Prüfgegenstandes (ZAP) an MD</xs:documentation> </xs:annotation>

	<pre> <xs:complexType> <xs:sequence> <xs:element name="AZ_KK" minOccurs="1"> <xs:annotation> <xs:documentation>ZAP01: Aktenzeichen der Krankenkasse</xs:documentation> </xs:annotation> <xs:simpleType> <xs:restriction base="xs:string"> <xs:minLength value="2"/> <xs:maxLength value="18"/> </xs:restriction> </xs:simpleType> </xs:element> <xs:element name="Datum_Antwort" type="md:Datum_Stp" minOccurs="1"> <xs:annotation> <xs:documentation>ZAP02: Datum der Antwort der Krankenkasse zur Erweiterung des Prüfgegenstandes</xs:documentation> </xs:annotation> </xs:element> <xs:element name="Antwort_Erweiterung_Pruefgegenstand" type="kh:Berechtigung_Erweiterung_Pruefgegenstand" minOccurs="1"> <xs:annotation> <xs:documentation>ZAP03: Antwort Erweiterung Prüfgegenstand (Schlüssel T)</xs:documentation> </xs:annotation> </xs:element> </xs:sequence> </xs:complexType> </xs:element> </pre>
--	---

element Beauftragung/Zwischennachricht_ZAP/AZ_KK

diagram										
namespace	http://www.aok-systems.de/xml-schema/mdk-kh-standard_V07.00									
type	restriction of xs:string									
properties	content simple									
facets	<table border="1"> <thead> <tr> <th>Kind</th> <th>Value</th> <th>Annotation</th> </tr> </thead> <tbody> <tr> <td>minLength</td> <td>2</td> <td></td> </tr> <tr> <td>maxLength</td> <td>18</td> <td></td> </tr> </tbody> </table>	Kind	Value	Annotation	minLength	2		maxLength	18	
Kind	Value	Annotation								
minLength	2									
maxLength	18									
annotation	documentation ZAP01: Aktenzeichen der Krankenkasse									
source	<pre> <xs:element name="AZ_KK" minOccurs="1"> <xs:annotation> <xs:documentation>ZAP01: Aktenzeichen der Krankenkasse</xs:documentation> </xs:annotation> <xs:simpleType> <xs:restriction base="xs:string"> </pre>									

	<pre> <xs: minLength value="2"/> <xs: maxLength value="18"/> </xs: restriction> </xs: simpleType> </xs: element> </pre>
--	---

element Beauftragung/Zwischennachricht_ZAP/Datum_Antwort

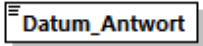
diagram	 <p>Datum_Antwort ZAP02: Datum der Antwort der Krankenkasse zur Erweiterung des Prüfgegenstandes</p>									
namespace	http://www.aok-systems.de/xml-schema/mdk-kh-standard_V07.00									
type	Datum_Stp									
properties	content simple									
facets	<table border="1"> <thead> <tr> <th>Kind</th> <th>Value</th> <th>Annotation</th> </tr> </thead> <tbody> <tr> <td>minInclusive</td> <td>1850-01-01</td> <td></td> </tr> <tr> <td>maxInclusive</td> <td>2099-12-31</td> <td></td> </tr> </tbody> </table>	Kind	Value	Annotation	minInclusive	1850-01-01		maxInclusive	2099-12-31	
Kind	Value	Annotation								
minInclusive	1850-01-01									
maxInclusive	2099-12-31									
annotation	documentation ZAP02: Datum der Antwort der Krankenkasse zur Erweiterung des Prüfgegenstandes									
source	<pre> <xs: element name="Datum_Antwort" type="md: Datum_Stp" minOccurs="1"> <xs: annotation> <xs: documentation>ZAP02: Datum der Antwort der Krankenkasse zur Erweiterung des Prüfgegenstandes</xs: documentation> </xs: annotation> </xs: element> </pre>									

element Beauftragung/Zwischennachricht_ZAP/Antwort_Erweiterung_Pruefgegenstand

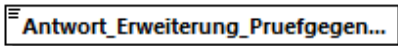
diagram	 <p>Antwort_Erweiterung_Pruefgegen... ZAP03: Antwort Erweiterung Prüfgegenstand (Schlüssel T)</p>									
namespace	http://www.aok-systems.de/xml-schema/mdk-kh-standard_V07.00									
type	Berechtigung_Erweiterung_Pruefgegenstand									
properties	content simple									
facets	<table border="1"> <thead> <tr> <th>Kind</th> <th>Value</th> <th>Annotation</th> </tr> </thead> <tbody> <tr> <td>enumeration</td> <td>0</td> <td></td> </tr> <tr> <td>enumeration</td> <td>1</td> <td></td> </tr> </tbody> </table>	Kind	Value	Annotation	enumeration	0		enumeration	1	
Kind	Value	Annotation								
enumeration	0									
enumeration	1									
annotation	documentation ZAP03: Antwort Erweiterung Prüfgegenstand (Schlüssel T)									
source	<pre> <xs: element name="Antwort_Erweiterung_Pruefgegenstand" type="kh: Berechtigung_Erweiterung_Pruefgegenstand" minOccurs="1"> <xs: annotation> <xs: documentation>ZAP03: Antwort Erweiterung Prüfgegenstand (Schlüssel T)</xs: documentation> </xs: annotation> </xs: element> </pre>									

```
</xs: annotation>
</xs: element>
```

element Beauftragung/Dokument

diagram																									
namespace	http://www.aok-systems.de/xml-schema/mdk-kh-standard_V07.00																								
type	Dokument_Ctp																								
properties	minOcc 0 maxOcc 9 content complex																								
attributes	<table border="1"> <thead> <tr> <th>Name</th> <th>Type</th> <th>Use</th> <th>Default</th> <th>Fixed</th> <th>Annotation</th> </tr> </thead> <tbody> <tr> <td>mime_type</td> <td>derived by: Freitext Ohne Zeilenumbrueche Stp</td> <td>required</td> <td></td> <td></td> <td>documentation DOK01: MIME-Type</td> </tr> <tr> <td>name</td> <td>derived by: Freitext Ohne Zeilenumbrueche Stp</td> <td>required</td> <td></td> <td></td> <td>documentation DOK02: Name des Dokumentes</td> </tr> <tr> <td>dok_typ</td> <td>derived by: Dok Typ Stp</td> <td>required</td> <td></td> <td></td> <td>documentation DOK03: Dokumententyp</td> </tr> </tbody> </table>	Name	Type	Use	Default	Fixed	Annotation	mime_type	derived by: Freitext Ohne Zeilenumbrueche Stp	required			documentation DOK01: MIME-Type	name	derived by: Freitext Ohne Zeilenumbrueche Stp	required			documentation DOK02: Name des Dokumentes	dok_typ	derived by: Dok Typ Stp	required			documentation DOK03: Dokumententyp
Name	Type	Use	Default	Fixed	Annotation																				
mime_type	derived by: Freitext Ohne Zeilenumbrueche Stp	required			documentation DOK01: MIME-Type																				
name	derived by: Freitext Ohne Zeilenumbrueche Stp	required			documentation DOK02: Name des Dokumentes																				
dok_typ	derived by: Dok Typ Stp	required			documentation DOK03: Dokumententyp																				
annotation	documentation DOK: Stammdaten Dokument																								
source	<pre><xs: element name="Dokument" type="md: Dokument_Ctp" minOccurs="0" maxOccurs="9"> <xs: annotation> <xs: documentation>DOK: Stammdaten Dokument</xs: documentation> </xs: annotation> </xs: element></pre>																								

element Begutachtung

diagram

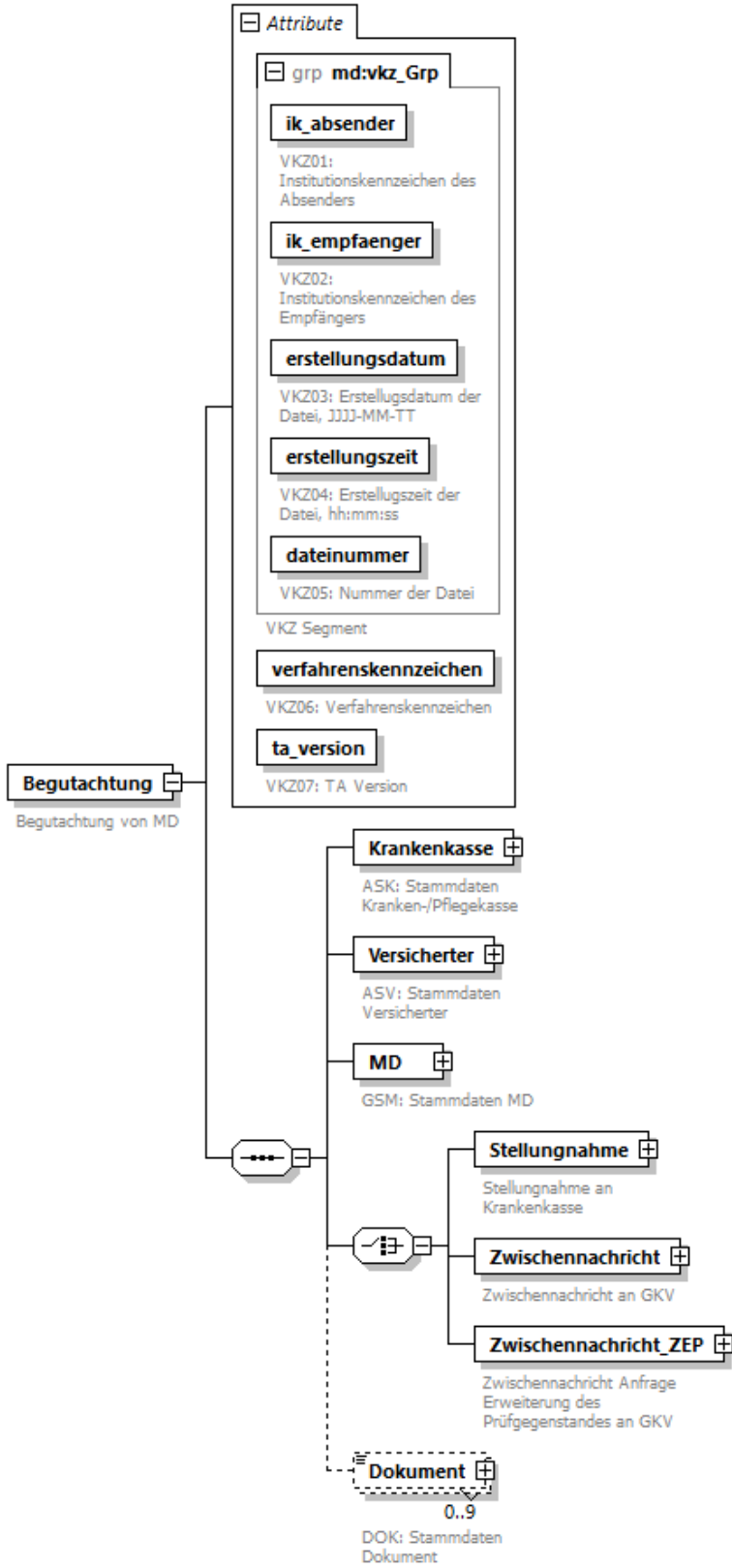

namespace	http://www.aok-systems.de/xml-schema/mdk-kh-standard_V07.00					
properties	content complex					
children	Krankenkasse Versicherter MD Stellungnahme Zwischennachricht Zwischennachricht_ZEP Dokument					
attributes	Name	Type	Use	Default	Fixed	Annotation
	ik_absender	IK_Stp	required			documentation VKZ01: Institutionskennzeichen des Absenders
	ik_empfaenger	IK_Stp	required			documentation VKZ02: Institutionskennzeichen des Empfängers
	erstellungdatum	Datum_Stp	required			documentation VKZ03: Erstellungsdatum der Datei, JJJJ-MM-TT
	erstellungzeit	Zeitpunkt_Stp	required			documentation VKZ04: Erstellungszeit der Datei, hh:mm:ss
	dateinummer	derived by: xs:positiveInteger	required			documentation VKZ05: Nummer der Datei
	verfahrenskennzeichen	Verfahrenskennzeichen_Stp	required			documentation VKZ06: Verfahrenskennzeichen
	ta_version	Schluessel_V_Stp	required			documentation VKZ07: TA Version
annotation	documentation Begutachtung von MD					
source	<pre> <xs:element name="Begutachtung"> <xs:annotation> <xs:documentation>Begutachtung von MD</xs:documentation> </xs:annotation> <xs:complexType> <xs:sequence> <xs:element name="Krankenkasse" type="md:Kasse_Ctp"> <xs:annotation> <xs:documentation>ASK: Stammdaten Kranken-/Pfl egekasse</xs:documentation> </xs:annotation> </xs:element> <xs:element name="Versi cherter" type="md:Versi cherter_Ctp"> <xs:annotation> <xs:documentation>ASV: Stammdaten Versi cherter</xs:documentation> </xs:annotation> </xs:element> <xs:element name="MD" type="md:MD_Ctp"> <xs:annotation> <xs:documentation>GSM: Stammdaten MD</xs:documentation> </xs:annotation> </xs:element> <xs:choice> <xs:element name="Stel l ungnahme"> <xs:annotation> <xs:documentation>Stel l ungnahme an Krankenkasse</xs:documentation> </xs:annotation> </xs:element> </xs:choice> </xs:sequence> </xs:complexType> </xs:element> </pre>					

```

</xs:annotation>
<xs:complexType>
  <xs:sequence>
    <xs:element name="Antworten" type="kh:CT_Antworten" minOccurs="0">
      <xs:annotation>
        <xs:documentation>GRK-Satz</xs:documentation>
      </xs:annotation>
      <xs:unique name="key_antwort">
        <xs:selector xpath="antwort"/>
        <xs:field xpath="@frage_ID"/>
      </xs:unique>
    </xs:element>
    <xs:element name="Pruefung">
      <xs:annotation>
        <xs:documentation>Notwendige Informationen und
Prüfungen</xs:documentation>
      </xs:annotation>
      <xs:complexType>
        <xs:sequence>
          <xs:element name="Fall daten">
            <xs:annotation>
              <xs:documentation>GFK-Satz</xs:documentation>
            </xs:annotation>
            <xs:complexType>
              <xs:sequence>
                <xs:element name="Aufnahme">
                  <xs:annotation>
                    <xs:documentation>GFK01 und
GFK02</xs:documentation>
                  </xs:annotation>
                  <xs:complexType>
                    <xs:attribute name="aufnahmegrund"
type="kh:Aufnahmegrund" use="required">
                      <xs:annotation>
                        <xs:documentation>GFK01:
Aufnahmegrund</xs:documentation>
                      </xs:annotation>
                      </xs:attribute>
                      <xs:attribute name="aufnahmeanl ass"
type="kh:Aufnahmeanl ass" use="required">
                        <xs:annotation>
                          <xs:documentation>GFK02: Aufnahmeanl ass
</xs:documentation>
                        </xs:annotation>
                        </xs:attribute>
                      </xs:complexType>
                    </xs:element>
                    <xs:element name="Entl assung" type="md:Datum_Stp"
minOccurs="0">
                      <xs:annotation>
                        <xs:documentation>GFK03: Voraussi chtli ches
Entlassungsdatum im Format (JJJJ-MM-TT)</xs:documentation>
                      </xs:annotation>
                      </xs:element>
                    <xs:element name="Gewi cht" minOccurs="0">

```

```

        <xs: annotation>
          <xs: documentation>GFK04: Aufnahmegewicht in
Gramm</xs: documentation>
        </xs: annotation>
        <xs: simpleType>
          <xs: restriction base="xs:int">
            <xs: minOccurs value="0" />
            <xs: maxInclusive value="99999" />
          </xs: restriction>
        </xs: simpleType>
      </xs: element>
    </xs: sequence>
  </xs: complexType>
</xs: element>
<xs: element name="Diagnosen">
  <xs: annotation>
    <xs: documentation>GDI -Satz und GFK05</xs: documentation>
  </xs: annotation>
  <xs: complexType>
    <xs: sequence>
      <xs: element name="Diagnose" maxOccurs="999">
        <xs: annotation>
          <xs: documentation>GDI -Sätze</xs: documentation>
        </xs: annotation>
        <xs: complexType>
          <xs: sequence>
            <xs: element name="KH">
              <xs: annotation>
                <xs: documentation>GDI 01 -GDI 03</xs: documentation>
              </xs: annotation>
              <xs: complexType>
                <xs: attribute name="diagnosetyp"
type="kh:Diagnosetyp" use="required">
                  <xs: annotation>
                    <xs: documentation>GDI 01:
Diagnosetyp</xs: documentation>
                  </xs: annotation>
                  </xs: attribute>
                  <xs: attribute name="icd" use="optional">
                    <xs: annotation>
                      <xs: documentation>GDI 02:
ICD-Schlüssel</xs: documentation>
                    </xs: annotation>
                    <xs: simpleType>
                      <xs: restriction
base="md:ICD_Schlüssel_Stp" />
                    </xs: simpleType>
                  </xs: attribute>
                  <xs: attribute name="lokalisaton"
type="md:Lokalisaton_Stp" use="optional">
                    <xs: annotation>
                      <xs: documentation>GDI 03:
Lokalisaton</xs: documentation>
                    </xs: annotation>

```

```

        </xs: attribute>
        </xs: complexType>
    </xs: element>
    <xs: element name="MD">
        <xs: annotation>

<xs: documentation>GDI 04-GDI 07</xs: documentation>
        </xs: annotation>
        <xs: complexType>
            <xs: attribute name="icd" use="optional">
                <xs: annotation>
                    <xs: documentation>GDI 04:
I CD-Schlüssel </xs: documentation>
                </xs: annotation>
                <xs: simpleType>
                    <xs: restriction
base="md: ICD_Schlüssel_Stp" />
                </xs: simpleType>
                </xs: attribute>
                <xs: attribute name="Lokalisation"
type="md: Lokalisation_Stp" use="optional">
                    <xs: annotation>
                        <xs: documentation>GDI 05:
Lokalisation</xs: documentation>
                </xs: annotation>
                </xs: attribute>
                <xs: attribute name="antwort"
type="kh: Antwortzeichen" use="required">
                    <xs: annotation>
                        <xs: documentation>GDI 06: Antwort
MD</xs: documentation>
                </xs: annotation>
                </xs: attribute>
                <xs: attribute name="erläuterung"
type="kh: Freitext_1024" use="optional">
                    <xs: annotation>
                        <xs: documentation>GDI 07: Erläuterungen
MD</xs: documentation>
                </xs: annotation>
                </xs: attribute>
            </xs: complexType>
        </xs: element>
    </xs: sequence>
</xs: complexType>
</xs: element>
</xs: sequence>
<xs: attribute name="icd_version" use="required">
    <xs: annotation>
        <xs: documentation>GFK05:
I CD-Version</xs: documentation>
    </xs: annotation>
    <xs: simpleType>
        <xs: restriction base="xs:gYear">
            <xs: minInclusive value="2003" />
            <xs: maxInclusive value="2099" />

```



```

        </xs:restriction>
        </xs:simpleType>
        </xs:attribute>
        </xs:complexType>
</xs:element>
<xs:element name="Prozeduren" minOccurs="0">
  <xs:annotation>
    <xs:documentation>GOP-Satz und GFK06</xs:documentation>
  </xs:annotation>
  <xs:complexType>
    <xs:sequence>
      <xs:element name="Prozedur" maxOccurs="999">
        <xs:annotation>
          <xs:documentation>GOP-Sätze</xs:documentation>
        </xs:annotation>
        <xs:complexType>
          <xs:sequence>
            <xs:element name="KH">
              <xs:annotation>
                <xs:documentation>GOP01-03</xs:documentation>
              </xs:annotation>
              <xs:complexType>
                <xs:attribute name="ops" use="optional">
                  <xs:annotation>
                    <xs:documentation>GOP01:
OPS-Schlüssel </xs:documentation>
                  </xs:annotation>
                </xs:simpleType>
                <xs:restriction
base="kh:OPS_Schlüssel"/>
              </xs:simpleType>
              </xs:attribute>
              <xs:attribute name="Lokalisation"
type="md:Lokalisation_Stp" use="optional">
                <xs:annotation>
                  <xs:documentation>GOP02:
Lokalisation</xs:documentation>
                </xs:annotation>
                </xs:attribute>
                <xs:attribute name="datum_ops"
type="md:Datum_Stp" use="optional">
                  <xs:annotation>
                    <xs:documentation>GOP03: Datum OPS im
Format (JJJJ-MM-TT)</xs:documentation>
                  </xs:annotation>
                </xs:attribute>
              </xs:complexType>
            </xs:element>
            <xs:element name="MD">
              <xs:annotation>
                <xs:documentation>GOP04-08</xs:documentation>
              </xs:annotation>
            </xs:element>
          </xs:sequence>
        </xs:complexType>
      </xs:element>
    </xs:sequence>
  </xs:complexType>
</xs:element>

```

```

        <xs: attribute name="ops"
type="kh: OPS_Schl uessel " use="opti onal ">
        <xs: annotati on>
        <xs: documentati on>GOP04: OPS-Schl üssel
MD</xs: documentati on>
        </xs: annotati on>
        </xs: attribute>
        <xs: attribute name="Lokal i sati on"
type="md: Lokal i sati on_Stp" use="opti onal ">
        <xs: annotati on>
        <xs: documentati on>GOP05: Lokal i sati on
MD</xs: documentati on>
        </xs: annotati on>
        </xs: attribute>
        <xs: attribute name="datum_ops"
type="md: Datum_Stp" use="opti onal ">
        <xs: annotati on>
        <xs: documentati on>GOP06: Datum OPS MD im
Format (JJJJ-MM-TT)</xs: documentati on>
        </xs: annotati on>
        </xs: attribute>
        <xs: attribute name="antwort"
type="kh: Antwortzei chen" use="requi red">
        <xs: annotati on>
        <xs: documentati on>GOP07: Antwort
MD</xs: documentati on>
        </xs: annotati on>
        </xs: attribute>
        <xs: attribute name="erl aeuterung"
type="kh: Frei text_1024" use="opti onal ">
        <xs: annotati on>
        <xs: documentati on>GOP08: Erl äuterungen
MD</xs: documentati on>
        </xs: annotati on>
        </xs: attribute>
        </xs: compl exType>
        </xs: el ement>
        </xs: sequence>
        </xs: compl exType>
        </xs: el ement>
</xs: sequence>
<xs: attribute name="ops_versi on" use="requi red">
<xs: annotati on>
<xs: documentati on>GFK06:
OPS-Versi on</xs: documentati on>
</xs: annotati on>
<xs: si mpl eType>
<xs: restri cti on base="xs: gYear">
<xs: mi ni ncl usi ve val ue="2003"/>
<xs: maxl ncl usi ve val ue="2099"/>
</xs: restri cti on>
</xs: si mpl eType>
</xs: attribute>
</xs: compl exType>
</xs: el ement>

```

```

<xs:element name="Entlassung" minOccurs="0">
  <xs:annotation>
    <xs:documentation>GEK-Satz</xs:documentation>
  </xs:annotation>
  <xs:complexType>
    <xs:sequence>
      <xs:element name="Abteilungstyp"
type="md:Abteilungstyp_Stp" minOccurs="0">
        <xs:annotation>
          <xs:documentation>GEK01: Zusatzschlüssel
Abteilungstyp MD</xs:documentation>
        </xs:annotation>
      </xs:element>
      <xs:element name="Entlassungsgrund"
type="kh:Entlassungsgrund">
        <xs:annotation>
          <xs:documentation>GEK02: Grund der Entlassung/
Verlegung MD</xs:documentation>
        </xs:annotation>
      </xs:element>
      <xs:choice>
        <xs:sequence>
          <xs:element name="MD_DRG" minOccurs="0">
            <xs:annotation>
              <xs:documentation>GEK03-04</xs:documentation>
            </xs:annotation>
          <xs:complexType>
            <xs:attribute name="DRG" use="optional">
              <xs:annotation>
                <xs:documentation>GEK03:
DRG-MD</xs:documentation>
              </xs:annotation>
            </xs:simpleType>
            <xs:restriction base="kh:DRG"/>
          </xs:complexType>
          <xs:attribute name="relativgewicht"
use="optional">
            <xs:annotation>
              <xs:documentation>GEK04: Eff.
Relativgewicht der DRG-MD</xs:documentation>
            </xs:annotation>
          </xs:simpleType>
          <xs:restriction base="xs:decimal">
            <xs:totalDigits value="8"/>
            <xs:fractionDigits value="3"/>
            <xs:maxExclusive value="100000"/>
          </xs:restriction>
        </xs:simpleType>
      </xs:attribute>
    </xs:complexType>
  </xs:element>
</xs:sequence>
</xs:sequence>
<xs:element name="MD_PEPP" minOccurs="0">

```

```

</xs: annotation>
<xs: annotation>GEK09: PEPP
MD</xs: documentati on>
</xs: annotation>
<xs: si mpl eType>
  <xs: restri cti on base="xs: string">
    <xs: maxLength val ue="5"/>
    <xs: mi nLength val ue="1"/>
  </xs: restri cti on>
</xs: si mpl eType>
</xs: el ement>
<xs: el ement name="Bewertungsrel ati on"
mi n0ccurs="0">
  <xs: annotation>
    <xs: documentati on>GEK10: Eff.
Bewertungsrelati on der PEPP MD</xs: documentati on>
  </xs: annotation>
  <xs: si mpl eType>
    <xs: restri cti on base="xs: deci mal ">
      <xs: total Di gi ts val ue="8"/>
      <xs: fracti onDi gi ts val ue="4"/>
      <xs: maxExcl usi ve val ue="10000"/>
    </xs: restri cti on>
  </xs: si mpl eType>
</xs: el ement>
</xs: sequence>
</xs: choi ce>
<xs: el ement name="Beatmungsstunden" mi n0ccurs="0">
  <xs: annotation>
    <xs: documentati on>GEK05: Anzahl
Beatmungsstunden</xs: documentati on>
  </xs: annotation>
  <xs: si mpl eType>
    <xs: restri cti on base="xs: i nt">
      <xs: mi nIncl usi ve val ue="0"/>
      <xs: maxIncl usi ve val ue="9999"/>
    </xs: restri cti on>
  </xs: si mpl eType>
</xs: el ement>
<xs: el ement name="Entbi ndung" mi n0ccurs="0"
max0ccurs="2">
  <xs: annotation>
    <xs: documentati on>GEK06-07: Tag der Entbi ndung MD i m
Format (JJJJ-MM-TT)</xs: documentati on>
  </xs: annotation>
  <xs: si mpl eType>
    <xs: restri cti on base="md: Datum_Stp"/>
  </xs: si mpl eType>
</xs: el ement>
<xs: el ement name="TOB" type="kh: Anzahl _Tage3"
mi n0ccurs="0">
  <xs: annotation>
    <xs: documentati on>GEK08: Tage ohne Berechnung
(TOB)</xs: documentati on>
  </xs: annotation>

```



```

        </xs: attribute>
        <xs: attribute name="TOB" type="kh: Anzahl_Tage3"
use="optional ">
        <xs: annotation>
        <xs: documentation>GEG06: Tage ohne
Berechnung/Behandlung</xs: documentation>
        </xs: annotation>
        </xs: attribute>
        </xs: complexType>
</xs: element>
<xs: element name="MD">
    <xs: annotation>
        <xs: documentation>GEG07-14</xs: documentation>
    </xs: annotation>
    <xs: complexType>
        <xs: attribute name="entgeltart"
type="kh: Entgeltart" use="optional ">
            <xs: annotation>
                <xs: documentation>GEG07: Entgeltart
MD</xs: documentation>
            </xs: annotation>
            </xs: attribute>
            <xs: attribute name="betrag" use="optional ">
                <xs: annotation>
                    <xs: documentation>GEG08: Entgeltbetrag
MD</xs: documentation>
                </xs: annotation>
                <xs: simpleType>
                    <xs: restriction base="xs: decimal ">
                        <xs: fractionDigits value="2" fixed="false"/>
                        <xs: totalDigits value="9"/>
                        <xs: maxExclusive value="100000000"/>
                    </xs: restriction>
                </xs: simpleType>
            </xs: attribute>
            <xs: attribute name="abrechnung_von"
type="md: Datum_Stp" use="optional ">
                <xs: annotation>
                    <xs: documentation>GEG09: Entgelt Abrechnung von
MD im Format (JJJJ-MM-TT)</xs: documentation>
                </xs: annotation>
                </xs: attribute>
                <xs: attribute name="abrechnung_bis"
type="md: Datum_Stp" use="optional ">
                    <xs: annotation>
                        <xs: documentation>GEG10: Entgelt Abrechnung bis
MD im Format (JJJJ-MM-TT)</xs: documentation>
                    </xs: annotation>
                    </xs: attribute>
                    <xs: attribute name="entgeltanzahl "
type="kh: Anzahl_Tage3" use="optional ">
                        <xs: annotation>
                            <xs: documentation>GEG11: Anzahl des
Entgeltschlüssels MD</xs: documentation>
                        </xs: annotation>

```



```

<xs:element name="Bereitstellung"
type="kh:Bereitstellung_Unterlagen" minOccurs="1">
  <xs:annotation>
    <xs:documentation>AGU03: Bereitstellung (Schlüssel
U)</xs:documentation>
  </xs:annotation>
</xs:element>
<xs:element name="Dokumententyp" minOccurs="1">
  <xs:annotation>
    <xs:documentation>AGU04: Dokumententyp nach
eVV</xs:documentation>
  </xs:annotation>
  <xs:simpleType>
    <xs:restriction base="xs:string">
      <xs:length value="8"/>
    </xs:restriction>
  </xs:simpleType>
</xs:element>
<xs:element name="Datum_Bereitstellung"
type="md:Datum_Stp" minOccurs="0">
  <xs:annotation>
    <xs:documentation>AGU05: Datum der Bereitstellung im
Format (JJJJ-MM-TT)</xs:documentation>
  </xs:annotation>
</xs:element>
<xs:element name="Hashwert" minOccurs="0">
  <xs:annotation>
    <xs:documentation>AGU06: Hashwert lt.
MD-Portal</xs:documentation>
  </xs:annotation>
  <xs:simpleType>
    <xs:restriction base="xs:string">
      <xs:length value="32"/>
    </xs:restriction>
  </xs:simpleType>
</xs:element>
<xs:element name="Anmerkungen" type="kh:Frei text_1024"
minOccurs="0">
  <xs:annotation>
    <xs:documentation>AGU07:
Anmerkungen</xs:documentation>
  </xs:annotation>
</xs:element>
</xs:sequence>
</xs:complexType>
</xs:element>
</xs:sequence>
</xs:complexType>
</xs:element>
</xs:sequence>
<xs:attribute name="geltungsbereich" use="required">
  <xs:annotation>
    <xs:documentation>GKH01: Gesetzlicher Geltungsbereich der
Abrechnung</xs:documentation>
  </xs:annotation>

```



```

<xs:simpleType>
  <xs:restriction base="kh: Abrechnungsart" />
</xs:simpleType>
</xs:attribute>
<xs:attribute name="fall_ID" use="optional">
  <xs:annotation>
    <xs:documentation>GKH02: Fall-ID KH
(Aufnahmenummer)</xs:documentation>
  </xs:annotation>
  <xs:simpleType>
    <xs:restriction base="kh: Fall_ID">
      <xs:minLength value="1" />
    </xs:restriction>
  </xs:simpleType>
</xs:attribute>
<xs:attribute name="erledigungsart" use="required">
  <xs:annotation>
    <xs:documentation>GKH03: Erledigungsart</xs:documentation>
  </xs:annotation>
  <xs:simpleType>
    <xs:restriction base="kh: Gutachtenart" />
  </xs:simpleType>
</xs:attribute>
<xs:attribute name="anlagen_PDF" use="required">
  <xs:annotation>
    <xs:documentation>GKH04: Anzahl der Anlagen</xs:documentation>
  </xs:annotation>
  <xs:simpleType>
    <xs:restriction base="xs:string">
      <xs:length value="1" />
      <xs:pattern value="[0-9]" />
    </xs:restriction>
  </xs:simpleType>
</xs:attribute>
<xs:attribute name="anlagen_post" use="required">
  <xs:annotation>
    <xs:documentation>GKH05: Anzahl der Anlagen per
Postweg</xs:documentation>
  </xs:annotation>
  <xs:simpleType>
    <xs:restriction base="xs:string">
      <xs:length value="1" />
      <xs:pattern value="[0-9]" />
    </xs:restriction>
  </xs:simpleType>
</xs:attribute>
<xs:attribute name="anlagen_post_text"
type="md:Frei text_Mit_Zeichen_Stp" use="optional">
  <xs:annotation>
    <xs:documentation>GKH06: Erläuterung Anlagen per
Postweg</xs:documentation>
  </xs:annotation>
</xs:attribute>
<xs:attribute name="gutachten_auswahl" use="required">
  <xs:annotation>

```

```

0=nein
    <xs:documentation>GKH07: Auswahl zur Begutachtung
    1=ja</xs:documentation>
  </xs:annotation>
</xs:simpleType>
  <xs:restriction base="xs:string">
    <xs:enumeration value="0"/>
    <xs:enumeration value="1"/>
  </xs:restriction>
</xs:simpleType>
</xs:attribute>
<xs:attribute name="rueckgabe" type="kh:Rueckgabegrund"
use="optional">
  <xs:annotation>
    <xs:documentation>GKH08: Rückgabegrund ohne
Auftragserledigung</xs:documentation>
  </xs:annotation>
</xs:attribute>
<xs:attribute name="erlaeuterung_rueckgabe" type="kh:Frei text_1024"
use="optional">
  <xs:annotation>
    <xs:documentation>GKH09: Erläuterung Rückgabegrund
'sonstiges' </xs:documentation>
  </xs:annotation>
</xs:attribute>
<xs:attribute name="ber_erw_fragestellung"
type="kh:Ber_Erw_Fragestellung" use="required">
  <xs:annotation>
    <xs:documentation>GKH10: Berechtigung des MD zur Ergänzung der
Fragestellung</xs:documentation>
  </xs:annotation>
</xs:attribute>
<xs:attribute name="wechsel_auftragsart"
type="kh:Wechsel_Auftragsart" use="required">
  <xs:annotation>
    <xs:documentation>GKH11: Berechtigung des MD zum Wechsel der
Auftragsart</xs:documentation>
  </xs:annotation>
</xs:attribute>
<xs:attribute name="art_begutachtung" type="kh:Art_Begutachtung"
use="required">
  <xs:annotation>
    <xs:documentation>GKH12: Art der Begutachtung</xs:documentation>
  </xs:annotation>
</xs:attribute>
<xs:attribute name="datum_unterlagenanforderung" type="md:Datum_Stp"
use="optional">
  <xs:annotation>
    <xs:documentation>GKH13: Datum der
Unterlagenanforderung</xs:documentation>
  </xs:annotation>
</xs:attribute>
</xs:complexType>
</xs:element>
<xs:element name="Zwischennachricht">
  <xs:annotation>

```

```

<xs:documentation>Zwischennachricht an GKV</xs:documentation>
</xs:annotation>
<xs:complexType>
  <xs:sequence>
    <xs:element name="Fragen" type="kh:CT_Neuer_Pruefanlass"
mi nOccurs="0">
      <xs:annotation>
        <xs:documentation>Fragestellungen des MD</xs:documentation>
      </xs:annotation>
      <xs:unique name="key_frage_z">
        <xs:selector xpath="kh:frage"/>
        <xs:field xpath="@frage_ID"/>
      </xs:unique>
    </xs:element>
    <xs:element name="Pruefantrag">
      <xs:annotation>
        <xs:documentation>Prüfauftragsdatum</xs:documentation>
      </xs:annotation>
      <xs:complexType>
        <xs:annotation>
          <xs:documentation>Prüfauftrag</xs:documentation>
        </xs:annotation>
        <xs:attribute name="erledigungsart" type="kh:Gutachtenart"
use="required">
          <xs:annotation>
            <xs:documentation>GZN01: Erledigungsart</xs:documentation>
          </xs:annotation>
          </xs:attribute>
          <xs:attribute name="aktenzeichen" type="md:Aktenzeichen_Stp"
use="required">
            <xs:annotation>
              <xs:documentation>GZN02: Aktenzeichen der
Krankenkasse</xs:documentation>
            </xs:annotation>
            </xs:attribute>
            <xs:attribute name="datum_anzeige" type="md:Datum_Stp"
use="optional">
              <xs:annotation>
                <xs:documentation>GZN03: Datum der Prüfanzeige im Format
(JJJJ-MM-TT)</xs:documentation>
              </xs:annotation>
              </xs:attribute>
              <xs:attribute name="datum_erweiterung" type="md:Datum_Stp"
use="optional">
                <xs:annotation>
                  <xs:documentation>GZN04: Datum Erweiterung des Prüfanlasses
im Format (JJJJ-MM-TT)</xs:documentation>
                </xs:annotation>
                </xs:attribute>
                <xs:attribute name="datum_beauftragung" type="md:Datum_Stp"
use="required">
                  <xs:annotation>
                    <xs:documentation>GZN05: Datum der Beauftragung im Format
(JJJJ-MM-TT)</xs:documentation>
                  </xs:annotation>

```

```

        </xs: attribute>
        </xs: complexType>
    </xs: element>
    <xs: element name="Pruefgegenstaende" type="kh: CT_Pruefgegenstand"
mi n0ccurs="0">
        <xs: annotation>
            <xs: documentati on>PGS-Sätze: Prüfgegenstand</xs: documentati on>
        </xs: annotation>
    </xs: element>
</xs: sequence>
</xs: complexType>
</xs: element>
<xs: element name="Zwi schennachri cht_ZEP">
    <xs: annotation>
        <xs: documentati on>Zwi schennachricht Anfrage Erwei terung des
Prüfgegenstandes an GKV</xs: documentati on>
    </xs: annotation>
    <xs: complexType>
        <xs: sequence>
            <xs: element name="Anfrage_ZEP" mi n0ccurs="1">
                <xs: annotation>
                    <xs: documentati on>Anfrage zur Erwei terung des Prüfgegenstandes
(ZEP)</xs: documentati on>
                </xs: annotation>
                <xs: complexType>
                    <xs: sequence>
                        <xs: element name="AZ_KK" mi n0ccurs="1">
                            <xs: annotation>
                                <xs: documentati on>ZEP01: Aktenzei chen der
Krankenkasse</xs: documentati on>
                            </xs: annotation>
                            <xs: simpleType>
                                <xs: restricti on base="xs: stri ng">
                                    <xs: mi nLength val ue="2" />
                                    <xs: maxLength val ue="18" />
                                </xs: restricti on>
                            </xs: simpleType>
                        </xs: element>
                        <xs: element name="Datum_Anfrage" type="md: Datum_Stp"
mi n0ccurs="1">
                            <xs: annotation>
                                <xs: documentati on>ZEP02: Datum der Anfrage zur Erwei terung
des Prüfgegenstandes im Format (JJJJ-MM-TT)</xs: documentati on>
                            </xs: annotation>
                        </xs: element>
                    </xs: sequence>
                </xs: complexType>
            </xs: element>
            <xs: element name="Pruefgegenstaende" type="kh: CT_Pruefgegenstand">
                <xs: annotation>
                    <xs: documentati on>PGS-Sätze: Prüfgegenstand</xs: documentati on>
                </xs: annotation>
                <xs: uni que name="key_preufgegenstand_zep">
                    <xs: selector xpath="kh: Pruefgegenstand" />
                    <xs: fi el d xpath="@pruefgegenstand" />
            </xs: element>
        </xs: sequence>
    </xs: complexType>
</xs: element>

```

```

        </xs: unique>
    </xs: element>
    <xs: element name="Fragen" type="kh: CT_Neuer_Pruefanl ass">
        <xs: annotation>
            <xs: documentation>Neue Fragestellungen des MD zum beauftragten
Fal I </xs: documentation>
        </xs: annotation>
        <xs: unique name="key_frage_zep">
            <xs: selector xpath="kh: frage" />
            <xs: field xpath="@frage_ID" />
        </xs: unique>
    </xs: element>
</xs: sequence>
</xs: complexType>
</xs: element>
</xs: choice>
<xs: element name="Dokument" type="md: Dokument_Ctp" minOccurs="0"
maxOccurs="9">
    <xs: annotation>
        <xs: documentation>DOK: Stammdaten Dokument</xs: documentation>
    </xs: annotation>
</xs: element>
</xs: sequence>
<xs: attributeGroup ref="md: vkz_Grp" />
<xs: attribute name="verfahrenskennzeichen"
type="kh: Verfahrenskennzeichen_Stp" use="required">
    <xs: annotation>
        <xs: documentation>VKZ06: Verfahrenskennzeichen</xs: documentation>
    </xs: annotation>
</xs: attribute>
<xs: attribute name="ta_version" type="kh: Schl uessel _V_Stp" use="required">
    <xs: annotation>
        <xs: documentation>VKZ07: TA Version</xs: documentation>
    </xs: annotation>
</xs: attribute>
</xs: complexType>
</xs: element>

```

attribute Begutachtung/@verfahrenskennzeichen

type	Verfahrenskennzeichen_Stp									
properties	use required									
facets	<table border="1"> <thead> <tr> <th>Kind</th> <th>Value</th> <th>Annotation</th> </tr> </thead> <tbody> <tr> <td>enumeration</td> <td>EMDK0</td> <td></td> </tr> <tr> <td>enumeration</td> <td>TMDK0</td> <td></td> </tr> </tbody> </table>	Kind	Value	Annotation	enumeration	EMDK0		enumeration	TMDK0	
Kind	Value	Annotation								
enumeration	EMDK0									
enumeration	TMDK0									
annotation	documentation VKZ06: Verfahrenskennzeichen									
source	<pre> <xs: attribute name="verfahrenskennzeichen" type="kh: Verfahrenskennzeichen_Stp" use="required"> <xs: annotation> <xs: documentation>VKZ06: Verfahrenskennzeichen</xs: documentation> </xs: annotation> </pre>									

	</xs:attribute>
--	-----------------

attribute Begutachtung/@ta_version

type	Schluessel V Stp									
properties	use required									
facets	<table><thead><tr><th>Kind</th><th>Value</th><th>Annotation</th></tr></thead><tbody><tr><td>pattern</td><td>[1-9][0-9]?\.[1-9]?[0-9]</td><td></td></tr><tr><td>enumeration</td><td>1.11</td><td></td></tr></tbody></table>	Kind	Value	Annotation	pattern	[1-9][0-9]?\.[1-9]?[0-9]		enumeration	1.11	
Kind	Value	Annotation								
pattern	[1-9][0-9]?\.[1-9]?[0-9]									
enumeration	1.11									
annotation	documentation VKZ07: TA Version									
source	<xs:attribute name="ta_version" type="kh:Schluessel_V_Stp" use="required"> <xs:annotation> <xs:documentation>VKZ07: TA Version</xs:documentation> </xs:annotation> </xs:attribute>									

element Begutachtung/Krankenkasse

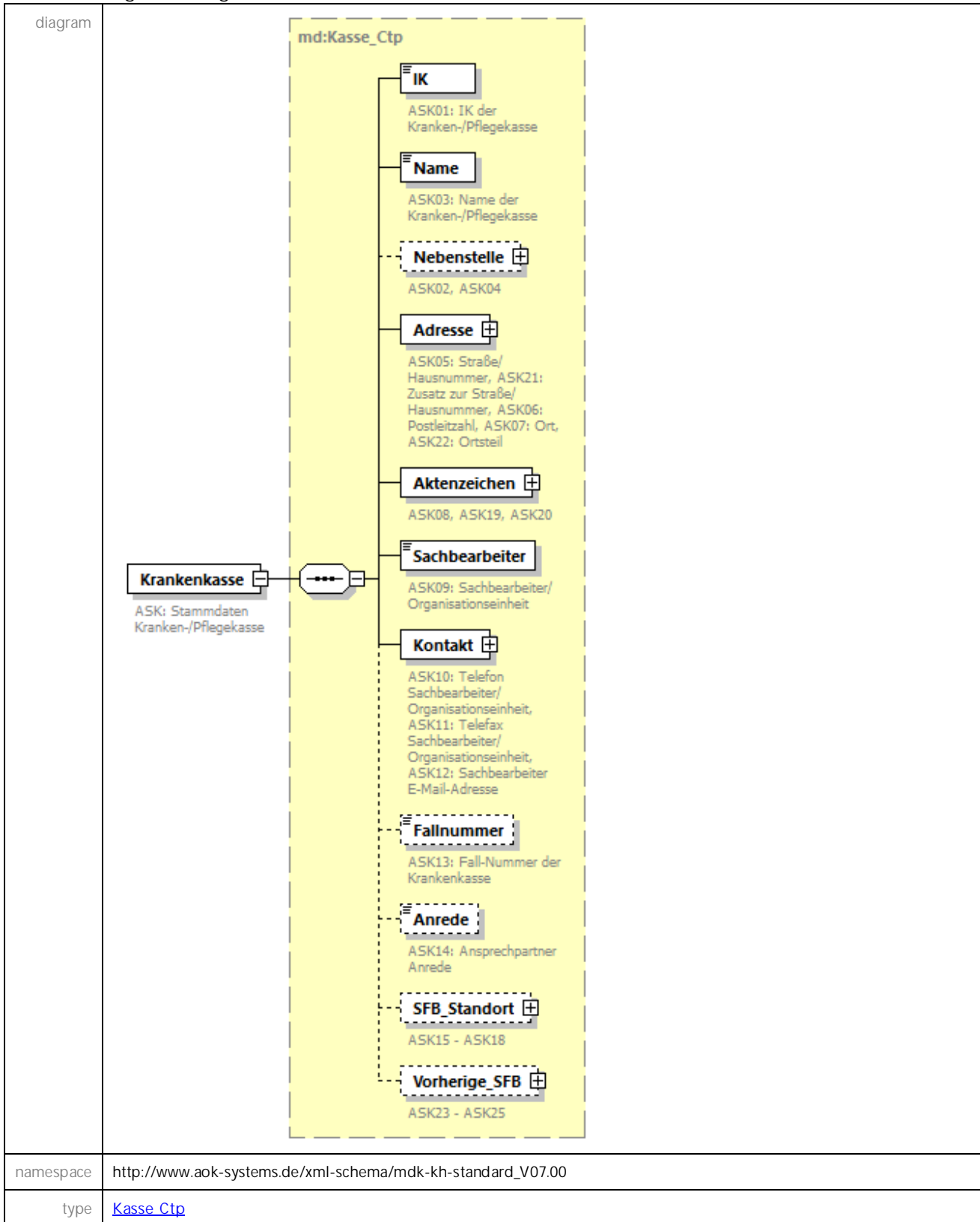

properties	content complex
children	IK Name Nebenstelle Adresse Aktenzeichen Sachbearbeiter Kontakt Fallnummer Anrede SFB Standort Vorherige SFB
annotation	documentation ASK: Stammdaten Kranken-/Pflegekasse
source	<xs:element name="Krankenkasse" type="md:Kasse_Ctp"> <xs:annotation> <xs:documentation>ASK: Stammdaten Kranken-/Pflegekasse</xs:documentation> </xs:annotation> </xs:element>

element Begutachtung/Versicherter

diagram	
namespace	http://www.aok-systems.de/xml-schema/mdk-kh-standard_V07.00
type	Versicherter_Ctp
properties	content complex

children	KV_PV_Nummer Person Adresse Kontakt
annotation	documentation ASV: Stammdaten Versicherter
source	<pre><xs:element name="Versicherter" type="md:Versicherter_Ctp"> <xs:annotation> <xs:documentation>ASV: Stammdaten Versicherter</xs:documentation> </xs:annotation> </xs:element></pre>

element Begutachtung/MD

diagram	
namespace	http://www.aok-systems.de/xml-schema/mdk-kh-standard_V07.00
type	MD_Ctp
properties	content complex
children	IK Beratungsstelle Adresse Ansprechpartner Kontakt
annotation	documentation GSM: Stammdaten MD
source	<pre><xs:element name="MD" type="md:MD_Ctp"> <xs:annotation> <xs:documentation>GSM: Stammdaten MD</xs:documentation> </xs:annotation> </xs:element></pre>

element Begutachtung/Stellungnahme

diagram

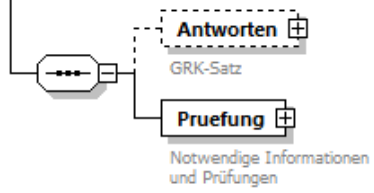
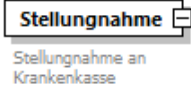

namespace	http://www.aok-systems.de/xml-schema/mdk-kh-standard_V07.00					
properties	content complex					
children	Antworten Pruefung					
attributes	Name	Type	Use	Default	Fixed	Annotation
	geltungsbereich	derived by: Abrechnungsart	required			documentation GKH01: Gesetzlicher Geltungsbereich der Abrechnung
	fall_ID	derived by: Fall_ID	optional			documentation GKH02: Fall-ID KH (Aufnahmenummer)
	erledigungsart	derived by: Gutachtenart	required			documentation GKH03: Erledigungsart
	anlagen_PDF	derived by: xs:string	required			documentation GKH04: Anzahl der Anlagen
	anlagen_post	derived by: xs:string	required			documentation GKH05: Anzahl der Anlagen per Postweg
	anlagen_post_text	Freitext Mit Zeichen Stp	optional			documentation GKH06: Erläuterung Anlagen per Postweg
	gutachten_auswahl	derived by: xs:string	required			documentation GKH07: Auswahl zur Begutachtung 0=nein 1=ja
	rueckgabe	Rueckgabegrund	optional			documentation GKH08: Rückgabegrund ohne Auftrags erledigung
	erlaeuterung_rueckgabe	Freitext_1024	optional			documentation GKH09: Erläuterung Rückgabegrund 'sonstiges'
	ber_erw_fragestellung	Ber Erw Fragestellung	required			documentation GKH10: Berechtigung des MD zur Ergänzung der Fragestellung
	wechsel_auftragsart	Wechsel Auftragsart	required			documentation GKH11: Berechtigung des MD zum Wechsel der Auftragsart
	art_begutachtung	Art Begutachtung	required			documentation GKH12: Art der Begutachtung
	datum_unterlagenanforderung	Datum Stp	optional			documentation GKH13: Datum der Unterlagenanforderung
annotation	documentation Stellungnahme an Krankenkasse					
source	<pre><xs:element name="Stellungnahme"> <xs:annotation> <xs:documentation>Stellungnahme an Krankenkasse</xs:documentation> </xs:annotation> <xs:complexType> <xs:sequence></pre>					

```

<xs:element name="Antworten" type="kh:CT_Antworten" minOccurs="0">
  <xs:annotation>
    <xs:documentation>GRK-Satz</xs:documentation>
  </xs:annotation>
  <xs:unique name="key_antwort">
    <xs:selector xpath="antwort"/>
    <xs:field xpath="@frage_ID"/>
  </xs:unique>
</xs:element>
<xs:element name="Pruefung">
  <xs:annotation>
    <xs:documentation>Notwendige Informationen und
Prüfungen</xs:documentation>
  </xs:annotation>
  <xs:complexType>
    <xs:sequence>
      <xs:element name="Falldaten">
        <xs:annotation>
          <xs:documentation>GFK-Satz</xs:documentation>
        </xs:annotation>
        <xs:complexType>
          <xs:sequence>
            <xs:element name="Aufnahme">
              <xs:annotation>
                <xs:documentation>GFK01 und GFK02</xs:documentation>
              </xs:annotation>
              <xs:complexType>
                <xs:attribute name="aufnahmegrund" type="kh:Aufnahmegrund"
use="required">
                  <xs:annotation>
                    <xs:documentation>GFK01:
Aufnahmegrund</xs:documentation>
                  </xs:annotation>
                  </xs:attribute>
                  <xs:attribute name="aufnahmeanlass"
type="kh:Aufnahmeanlass" use="required">
                    <xs:annotation>
                      <xs:documentation>GFK02: Aufnahmeanlass
</xs:documentation>
                    </xs:annotation>
                    </xs:attribute>
                  </xs:complexType>
                </xs:element>
              <xs:element name="Entlassung" type="md:Datum_Stp"
minOccurs="0">
                <xs:annotation>
                  <xs:documentation>GFK03: Voraussichtliches Entlassungsdatum
im Format (JJJJ-MM-TT)</xs:documentation>
                </xs:annotation>
                </xs:element>
              <xs:element name="Gewicht" minOccurs="0">
                <xs:annotation>
                  <xs:documentation>GFK04: Aufnahmegewicht in
Gramm</xs:documentation>
                </xs:annotation>
              </xs:element>
            </xs:sequence>
          </xs:complexType>
        </xs:element>
      </xs:sequence>
    </xs:complexType>
  </xs:element>

```

```

<xs: simpleType>
  <xs: restriction base="xs: int">
    <xs: minOccurs value="0"/>
    <xs: maxInclusive value="99999"/>
  </xs: restriction>
</xs: simpleType>
</xs: element>
</xs: sequence>
</xs: complexType>
</xs: element>
<xs: element name="Diagnosen">
  <xs: annotation>
    <xs: documentation>GDI -Satz und GFK05</xs: documentation>
  </xs: annotation>
  <xs: complexType>
    <xs: sequence>
      <xs: element name="Diagnose" maxOccurs="999">
        <xs: annotation>
          <xs: documentation>GDI -Sätze</xs: documentation>
        </xs: annotation>
        <xs: complexType>
          <xs: sequence>
            <xs: element name="KH">
              <xs: annotation>
                <xs: documentation>GDI 01-GDI 03</xs: documentation>
              </xs: annotation>
              <xs: complexType>
                <xs: attribute name="diagnosetyp"
type="kh: Diagnosetyp" use="required">
                  <xs: annotation>
                    <xs: documentation>GDI 01:
Diagnosentyp</xs: documentation>
                  </xs: annotation>
                </xs: attribute>
                <xs: attribute name="icd" use="optional">
                  <xs: annotation>
                    <xs: documentation>GDI 02:
ICD-Schlüssel </xs: documentation>
                  </xs: annotation>
                <xs: simpleType>
                  <xs: restriction base="md: ICD_Schlüssel_Stp"/>
                </xs: simpleType>
                </xs: attribute>
                <xs: attribute name="lokalisaton"
type="md: Lokalisaton_Stp" use="optional">
                  <xs: annotation>
                    <xs: documentation>GDI 03:
Lokalisaton</xs: documentation>
                  </xs: annotation>
                </xs: attribute>
              </xs: complexType>
            </xs: element>
            <xs: element name="MD">
              <xs: annotation>
                <xs: documentation>GDI 04-GDI 07</xs: documentation>
              </xs: annotation>
            </xs: element>
          </xs: sequence>
        </xs: complexType>
      </xs: element>
    </xs: sequence>
  </xs: complexType>
</xs: element>

```

```

        </xs: annotation>
        <xs: complexType>
          <xs: attribute name="icd" use="optional">
            <xs: annotation>
              <xs: documentation>GDI 04:
I CD-Schlüssel </xs: documentation>
            </xs: annotation>
            <xs: simpleType>
              <xs: restriction base="md: ICD_Schlüssel_Stp"/>
            </xs: simpleType>
            </xs: attribute>
            <xs: attribute name="lokalisierung"
type="md: Lokalisierung_Stp" use="optional">
              <xs: annotation>
                <xs: documentation>GDI 05:
Lokalisierung</xs: documentation>
              </xs: annotation>
              </xs: attribute>
            <xs: attribute name="antwort" type="kh: Antwortzeichen"
use="required">
              <xs: annotation>
                <xs: documentation>GDI 06: Antwort
MD</xs: documentation>
              </xs: annotation>
              </xs: attribute>
            <xs: attribute name="erläuterung"
type="kh: Freitext_1024" use="optional">
              <xs: annotation>
                <xs: documentation>GDI 07: Erläuterungen
MD</xs: documentation>
              </xs: annotation>
              </xs: attribute>
            </xs: complexType>
          </xs: element>
        </xs: sequence>
      </xs: complexType>
    </xs: element>
  </xs: sequence>
  <xs: attribute name="icd_version" use="required">
    <xs: annotation>
      <xs: documentation>GFK05: ICD-Version</xs: documentation>
    </xs: annotation>
    <xs: simpleType>
      <xs: restriction base="xs:gYear">
        <xs: minInclusive value="2003"/>
        <xs: maxInclusive value="2099"/>
      </xs: restriction>
    </xs: simpleType>
  </xs: attribute>
</xs: complexType>
</xs: element>
<xs: element name="Prozeduren" minOccurs="0">
  <xs: annotation>
    <xs: documentation>GOP-Satz und GFK06</xs: documentation>
  </xs: annotation>

```



```

<xs:complexType>
  <xs:sequence>
    <xs:element name="Prozedur" maxOccurs="999">
      <xs:annotation>
        <xs:documentation>GOP-Sätze</xs:documentation>
      </xs:annotation>
      <xs:complexType>
        <xs:sequence>
          <xs:element name="KH">
            <xs:annotation>
              <xs:documentation>GOP01-03</xs:documentation>
            </xs:annotation>
            <xs:complexType>
              <xs:attribute name="ops" use="optional">
                <xs:annotation>
                  <xs:documentation>GOP01:
OPS-Schlüssel </xs:documentation>
                </xs:annotation>
              </xs:attribute>
              <xs:simpleType>
                <xs:restriction base="kh:OPS_Schlüssel"/>
              </xs:simpleType>
              <xs:attribute name="lokalisaton"
type="md:Lokalisaton_Stp" use="optional">
                <xs:annotation>
                  <xs:documentation>GOP02:
Lokalisaton</xs:documentation>
                </xs:annotation>
              </xs:attribute>
              <xs:attribute name="datum_ops" type="md:Datum_Stp"
use="optional">
                <xs:annotation>
                  <xs:documentation>GOP03: Datum OPS im Format
(JJJJ-MM-TT)</xs:documentation>
                </xs:annotation>
              </xs:attribute>
            </xs:complexType>
          </xs:element>
          <xs:element name="MD">
            <xs:annotation>
              <xs:documentation>GOP04-08</xs:documentation>
            </xs:annotation>
            <xs:complexType>
              <xs:attribute name="ops" type="kh:OPS_Schlüssel"
use="optional">
                <xs:annotation>
                  <xs:documentation>GOP04: OPS-Schlüssel
MD</xs:documentation>
                </xs:annotation>
              </xs:attribute>
              <xs:attribute name="lokalisaton"
type="md:Lokalisaton_Stp" use="optional">
                <xs:annotation>
                  <xs:documentation>GOP05: Lokalisaton
MD</xs:documentation>
                </xs:annotation>
              </xs:attribute>
            </xs:complexType>
          </xs:element>
        </xs:sequence>
      </xs:complexType>
    </xs:element>
  </xs:sequence>
</xs:complexType>

```

```

        </xs: annotation>
        </xs: attribute>
        <xs: attribute name="datum_ops" type="md: Datum_Stp"
use="opti onal ">
        <xs: annotation>
        <xs: documentati on>GOP06: Datum OPS MD im Format
(JJJJ-MM-TT)</xs: documentati on>
        </xs: annotation>
        </xs: attribute>
        <xs: attribute name="antwort" type="kh: Antwortzei chen"
use="requi red">
        <xs: annotation>
        <xs: documentati on>GOP07: Antwort
MD</xs: documentati on>
        <xs: annotation>
        </xs: attribute>
        <xs: attribute name="erl aeuterung"
type="kh: Frei text_1024" use="opti onal ">
        <xs: annotation>
        <xs: documentati on>GOP08: Erl äuterungen
MD</xs: documentati on>
        </xs: annotation>
        </xs: attribute>
        </xs: complexType>
        </xs: element>
        </xs: sequence>
        </xs: complexType>
        </xs: element>
        </xs: sequence>
        <xs: attribute name="ops_versi on" use="requi red">
        <xs: annotation>
        <xs: documentati on>GFK06: OPS-Versi on</xs: documentati on>
        </xs: annotation>
        <xs: simpleType>
        <xs: restricti on base="xs: gYear">
        <xs: mi nIncl usi ve val ue="2003"/>
        <xs: maxIncl usi ve val ue="2099"/>
        </xs: restricti on>
        </xs: simpleType>
        </xs: attribute>
        </xs: complexType>
        </xs: element>
        <xs: element name="Entl assung" mi nOccurs="0">
        <xs: annotation>
        <xs: documentati on>GEK-Satz</xs: documentati on>
        </xs: annotation>
        <xs: complexType>
        <xs: sequence>
        <xs: element name="Abtei lungstyp" type="md: Abtei lungstyp_Stp"
mi nOccurs="0">
        <xs: annotation>
        <xs: documentati on>GEK01: Zusatzschlüssel Abtei lungstyp
MD</xs: documentati on>
        </xs: annotation>
        </xs: element>

```

```

<xs:element name="Entlassungsgrund" type="kh:Entlassungsgrund">
  <xs:annotation>
    <xs:documentation>GEK02: Grund der Entlassung/ Verlegung
MD</xs:documentation>
  </xs:annotation>
</xs:element>
<xs:choice>
  <xs:sequence>
    <xs:element name="MD_DRG" minOccurs="0">
      <xs:annotation>
        <xs:documentation>GEK03-04</xs:documentation>
      </xs:annotation>
      <xs:complexType>
        <xs:attribute name="DRG" use="optional">
          <xs:annotation>
            <xs:documentation>GEK03: DRG-MD</xs:documentation>
          </xs:annotation>
          <xs:simpleType>
            <xs:restriction base="kh:DRG"/>
          </xs:simpleType>
        </xs:attribute>
        <xs:attribute name="relativgewicht" use="optional">
          <xs:annotation>
            <xs:documentation>GEK04: Eff. Relativgewicht der
DRG-MD</xs:documentation>
          </xs:annotation>
          <xs:simpleType>
            <xs:restriction base="xs:decimal">
              <xs:totalDigits value="8"/>
              <xs:fractionDigits value="3"/>
              <xs:maxExclusive value="100000"/>
            </xs:restriction>
          </xs:simpleType>
        </xs:attribute>
      </xs:complexType>
    </xs:element>
  </xs:sequence>
  <xs:sequence>
    <xs:element name="MD_PEPP" minOccurs="0">
      <xs:annotation>
        <xs:documentation>GEK09: PEPP MD</xs:documentation>
      </xs:annotation>
      <xs:simpleType>
        <xs:restriction base="xs:string">
          <xs:maxLength value="5"/>
          <xs:minLength value="1"/>
        </xs:restriction>
      </xs:simpleType>
    </xs:element>
    <xs:element name="Bewertungsrelation" minOccurs="0">
      <xs:annotation>
        <xs:documentation>GEK10: Eff. Bewertungsrelation der
PEPP MD</xs:documentation>
      </xs:annotation>
      <xs:simpleType>

```

```

        <xs:restriction base="xs:decimal">
          <xs:totalDigits value="8"/>
          <xs:fractionDigits value="4"/>
          <xs:maxExclusive value="10000"/>
        </xs:restriction>
      </xs:simpleType>
    </xs:element>
  </xs:sequence>
</xs:choice>
<xs:element name="Beatmungsstunden" minOccurs="0">
  <xs:annotation>
    <xs:documentation>GEK05: Anzahl
Beatmungsstunden</xs:documentation>
  </xs:annotation>
  <xs:simpleType>
    <xs:restriction base="xs:int">
      <xs:minInclusive value="0"/>
      <xs:maxInclusive value="9999"/>
    </xs:restriction>
  </xs:simpleType>
</xs:element>
<xs:element name="Entbindung" minOccurs="0" maxOccurs="2">
  <xs:annotation>
    <xs:documentation>GEK06-07: Tag der Entbindung MD im Format
(JJJJ-MM-TT)</xs:documentation>
  </xs:annotation>
  <xs:simpleType>
    <xs:restriction base="md:Datum_Stp"/>
  </xs:simpleType>
</xs:element>
<xs:element name="TOB" type="kh:Anzahl_Tage3" minOccurs="0">
  <xs:annotation>
    <xs:documentation>GEK08: Tage ohne Berechnung
(TOB)</xs:documentation>
  </xs:annotation>
</xs:element>
</xs:sequence>
</xs:complexType>
</xs:element>
<xs:element name="Entgelte" minOccurs="0" maxOccurs="999">
  <xs:annotation>
    <xs:documentation>GEG-Sätze</xs:documentation>
  </xs:annotation>
  <xs:complexType>
    <xs:sequence>
      <xs:element name="KH">
        <xs:annotation>
          <xs:documentation>GEG01-06</xs:documentation>
        </xs:annotation>
        <xs:complexType>
          <xs:attribute name="entgeltart" type="kh:Entgeltart"
use="optional">
            <xs:annotation>
              <xs:documentation>GEG01: Entgeltart</xs:documentation>
            </xs:annotation>

```

```

</xs: attribute>
<xs: attribute name="betrag" use="optional ">
  <xs: annotation>
    <xs: documentati on>GEG02: Entgel tbetrag
  </xs: documentati on>
  </xs: annotation>
  <xs: simpleType>
    <xs: restricti on base="xs: decimal ">
      <xs: fracti onDi gi ts val ue="2" fixed="fal se"/>
      <xs: total Di gi ts val ue="9"/>
      <xs: maxExcl usi ve val ue="100000000"/>
    </xs: restricti on>
  </xs: simpleType>
</xs: attribute>
<xs: attribute name="abrechnung_von" type="md: Datum_Stp"
use="opti onal ">
  <xs: annotation>
    <xs: documentati on>GEG03: Entgel t Abrechnung von im
Format(JJJJ-MM-TT)</xs: documentati on>
  </xs: annotation>
</xs: attribute>
<xs: attribute name="abrechnung_bi s" type="md: Datum_Stp"
use="opti onal ">
  <xs: annotation>
    <xs: documentati on>GEG04: Entgel t Abrechnung bi s im
Format(JJJJ-MM-TT)</xs: documentati on>
  </xs: annotation>
</xs: attribute>
<xs: attribute name="entgel t_anzahl " type="kh: Anzahl _Tage3"
use="opti onal ">
  <xs: annotation>
    <xs: documentati on>GEG05: Anzahl des
Entgel tschl üssel s</xs: documentati on>
  </xs: annotation>
</xs: attribute>
<xs: attribute name="TOB" type="kh: Anzahl _Tage3"
use="opti onal ">
  <xs: annotation>
    <xs: documentati on>GEG06: Tage ohne
Berechnung/Behandl ung</xs: documentati on>
  </xs: annotation>
</xs: attribute>
</xs: compl exType>
</xs: el ement>
<xs: el ement name="MD">
  <xs: annotation>
    <xs: documentati on>GEG07-14</xs: documentati on>
  </xs: annotation>
  <xs: compl exType>
    <xs: attribute name="entgel tart" type="kh: Entgel tart"
use="opti onal ">
      <xs: annotation>
        <xs: documentati on>GEG07: Entgel tart
      </xs: annotation>
    </xs: attribute>
  </xs: compl exType>
</xs: el ement>
MD</xs: documentati on>
</xs: annotation>

```

```

</xs: attribute>
<xs: attribute name="betrag" use="optional ">
  <xs: annotation>
    <xs: documentati on>GEG08: Entgel tbetrag
MD</xs: documentati on>
  </xs: annotation>
  <xs: simpleType>
    <xs: restricti on base="xs: deci mal ">
      <xs: fracti onDi gi ts val ue="2" fi xed="fal se"/>
      <xs: total Di gi ts val ue="9"/>
      <xs: maxExcl usi ve val ue="100000000"/>
    </xs: restricti on>
  </xs: simpleType>
</xs: attribute>
<xs: attribute name="abrechnung_von" type="md: Datum_Stp"
use="opti onal ">
  <xs: annotation>
    <xs: documentati on>GEG09: Entgel t Abrechnung von MD im
Format (JJJJ-MM-TT)</xs: documentati on>
  </xs: annotation>
</xs: attribute>
<xs: attribute name="abrechnung_bi s" type="md: Datum_Stp"
use="opti onal ">
  <xs: annotation>
    <xs: documentati on>GEG10: Entgel t Abrechnung bi s MD im
Format (JJJJ-MM-TT)</xs: documentati on>
  </xs: annotation>
</xs: attribute>
<xs: attribute name="entgel t_anzahl " type="kh: Anzahl _Tage3"
use="opti onal ">
  <xs: annotation>
    <xs: documentati on>GEG11: Anzahl des Entgel tschl üssel s
MD</xs: documentati on>
  </xs: annotation>
</xs: attribute>
<xs: attribute name="TOB" type="kh: Anzahl _Tage3"
use="opti onal ">
  <xs: annotation>
    <xs: documentati on>GEG12: Tage ohne
Berechnung/Behandl ung MD</xs: documentati on>
  </xs: annotation>
</xs: attribute>
<xs: attribute name="antwort" type="kh: Antwortzei chen"
use="requi red">
  <xs: annotation>
    <xs: documentati on>GEG13: Antwort MD</xs: documentati on>
  </xs: annotation>
</xs: attribute>
<xs: attribute name="erl aeuterung" type="kh: Frei text_1024"
use="opti onal ">
  <xs: annotation>
    <xs: documentati on>GEG14: Erl äuterungen
MD</xs: documentati on>
  </xs: annotation>
</xs: attribute>

```

```

        </xs: complexType>
        </xs: element>
    </xs: sequence>
</xs: complexType>
</xs: element>
    <xs: element name="Aktenzeichen_anderer_Begutachtungsfall"
type="md: Aktenzeichen_anderer_Begutachtungsfall_Ctp" minOccurs="0" maxOccurs="9">
        <xs: annotation>
            <xs: documentation>AAB: Aktenzeichen anderer
Begutachtungsfall</xs: documentation>
        </xs: annotation>
    </xs: element>
    <xs: element name="Angef_Geliefert_Unterlagen" minOccurs="0"
maxOccurs="9999">
        <xs: annotation>
            <xs: documentation>AGU-Sätze</xs: documentation>
        </xs: annotation>
        <xs: complexType>
            <xs: sequence>
                <xs: element name="Unterlagen_Bezeichnung"
type="kh: Freitext_1024" minOccurs="1">
                    <xs: annotation>
                        <xs: documentation>AGU01: Unterlagen
Bezeichnung</xs: documentation>
                    </xs: annotation>
                </xs: element>
                <xs: element name="Datum_Anforderung" type="md: Datum_Stp"
minOccurs="0">
                    <xs: annotation>
                        <xs: documentation>AGU02: Datum der Anforderung im Format
(JJJJ-MM-TT)</xs: documentation>
                    </xs: annotation>
                </xs: element>
                <xs: element name="Bereitstellung"
type="kh: Bereitstellung_Unterlagen" minOccurs="1">
                    <xs: annotation>
                        <xs: documentation>AGU03: Bereitstellung (Schlüssel
U)</xs: documentation>
                    </xs: annotation>
                </xs: element>
                <xs: element name="Dokumententyp" minOccurs="1">
                    <xs: annotation>
                        <xs: documentation>AGU04: Dokumententyp nach
eVW</xs: documentation>
                    </xs: annotation>
                <xs: simpleType>
                    <xs: restriction base="xs: string">
                        <xs: length value="8"/>
                    </xs: restriction>
                </xs: simpleType>
            </xs: sequence>
        </xs: element>
        <xs: element name="Datum_Bereitstellung" type="md: Datum_Stp"
minOccurs="0">
            <xs: annotation>
                <xs: documentation>AGU05: Datum der Bereitstellung im Format

```

```

(JJJJ-MM-TT)</xs:documentati on>
  </xs:annotati on>
</xs:el ement>
<xs:el ement name="Hashwert" mi nOccurs="0">
  <xs:annotati on>
    <xs:documentati on>AGU06: Hashwert I t.
MD-Portal </xs:documentati on>
  </xs:annotati on>
  <xs:simpl eType>
    <xs:restricti on base="xs:stri ng">
      <xs:length val ue="32"/>
    </xs:restricti on>
  </xs:simpl eType>
</xs:el ement>
<xs:el ement name="Anmerkungen" type="kh:Frei text_1024"
mi nOccurs="0">
  <xs:annotati on>
    <xs:documentati on>AGU07: Anmerkungen</xs:documentati on>
  </xs:annotati on>
</xs:el ement>
</xs:sequence>
</xs:compl exType>
</xs:el ement>
</xs:sequence>
</xs:compl exType>
</xs:el ement>
</xs:sequence>
<xs:attri bute name="gel tungsberei ch" use="requi red">
  <xs:annotati on>
    <xs:documentati on>GKH01: Gesetzli cher Gel tungsberei ch der
Abrechnung</xs:documentati on>
  </xs:annotati on>
  <xs:simpl eType>
    <xs:restricti on base="kh:Abrechnungsart"/>
  </xs:simpl eType>
</xs:attri bute>
<xs:attri bute name="fall _ID" use="opti onal ">
  <xs:annotati on>
    <xs:documentati on>GKH02: Fall -ID KH (Aufnahmenummer)</xs:documentati on>
  </xs:annotati on>
  <xs:simpl eType>
    <xs:restricti on base="kh:Fall _ID">
      <xs:minLength val ue="1"/>
    </xs:restricti on>
  </xs:simpl eType>
</xs:attri bute>
<xs:attri bute name="erl edi gungsart" use="requi red">
  <xs:annotati on>
    <xs:documentati on>GKH03: Erl edi gungsart</xs:documentati on>
  </xs:annotati on>
  <xs:simpl eType>
    <xs:restricti on base="kh:Gutachtenart"/>
  </xs:simpl eType>
</xs:attri bute>
<xs:attri bute name="anl agen_PDF" use="requi red">

```



```

<xs: annotation>
  <xs: documentation>GKH04: Anzahl der Anlagen</xs: documentation>
</xs: annotation>
<xs: simpleType>
  <xs: restriction base="xs:string">
    <xs:length value="1"/>
    <xs:pattern value="[0-9]"/>
  </xs:restriction>
</xs:simpleType>
</xs:attribute>
<xs:attribute name="anlagen_post" use="required">
  <xs: annotation>
    <xs: documentation>GKH05: Anzahl der Anlagen per Postweg</xs: documentation>
  </xs: annotation>
  <xs: simpleType>
    <xs: restriction base="xs:string">
      <xs:length value="1"/>
      <xs:pattern value="[0-9]"/>
    </xs:restriction>
  </xs:simpleType>
</xs:attribute>
<xs:attribute name="anlagen_post_text" type="md:Frei text_Mit_Zeichen_Stp"
use="optional">
  <xs: annotation>
    <xs: documentation>GKH06: Erläuterung Anlagen per
Postweg</xs: documentation>
  </xs: annotation>
</xs:attribute>
<xs:attribute name="gutachten_auswahl" use="required">
  <xs: annotation>
    <xs: documentation>GKH07: Auswahl zur Begutachtung
1=ja 0=nein</xs: documentation>
  </xs: annotation>
  <xs: simpleType>
    <xs: restriction base="xs:string">
      <xs:enumeration value="0"/>
      <xs:enumeration value="1"/>
    </xs:restriction>
  </xs:simpleType>
</xs:attribute>
<xs:attribute name="rueckgabe" type="kh:Rueckgabegrund" use="optional">
  <xs: annotation>
    <xs: documentation>GKH08: Rückgabegrund ohne
Auftragserledigung</xs: documentation>
  </xs: annotation>
</xs:attribute>
<xs:attribute name="erlaeuterung_rueckgabe" type="kh:Frei text_1024"
use="optional">
  <xs: annotation>
    <xs: documentation>GKH09: Erläuterung Rückgabegrund
'sonstiges'</xs: documentation>
  </xs: annotation>
</xs:attribute>
<xs:attribute name="ber_erw_fragestellung" type="kh:Ber_Erw_Fragestellung"
use="required">

```

	<pre> <xs: annotation> <xs: documentation>GKH10: Berechtigung des MD zur Ergänzung der Fragestellung</xs: documentation> </xs: annotation> </xs: attribute> <xs: attribute name="wechsel_auftragsart" type="kh: Wechsel_Auftragsart" use="required"> <xs: annotation> <xs: documentation>GKH11: Berechtigung des MD zum Wechsel der Auftragsart</xs: documentation> </xs: annotation> </xs: attribute> <xs: attribute name="art_begutachtung" type="kh: Art_Begutachtung" use="required"> <xs: annotation> <xs: documentation>GKH12: Art der Begutachtung</xs: documentation> </xs: annotation> </xs: attribute> <xs: attribute name="datum_unterlagenanforderung" type="md: Datum_Stp" use="optional"> <xs: annotation> <xs: documentation>GKH13: Datum der Unterlagenanforderung</xs: documentation> </xs: annotation> </xs: attribute> </xs: complexType> </xs: element> </pre>
--	--

attribute Begutachtung/Stellungnahme/@geltungsbereich

type	restriction of Abrechnungsart												
properties	use required												
facets	<table border="1"> <thead> <tr> <th>Kind</th> <th>Value</th> <th>Annotation</th> </tr> </thead> <tbody> <tr> <td>enumeration</td> <td>01</td> <td></td> </tr> <tr> <td>enumeration</td> <td>02</td> <td></td> </tr> <tr> <td>enumeration</td> <td>09</td> <td></td> </tr> </tbody> </table>	Kind	Value	Annotation	enumeration	01		enumeration	02		enumeration	09	
Kind	Value	Annotation											
enumeration	01												
enumeration	02												
enumeration	09												
annotation	documentation GKH01: Gesetzlicher Geltungsbereich der Abrechnung												
source	<pre> <xs: attribute name="geltungsbereich" use="required"> <xs: annotation> <xs: documentation>GKH01: Gesetzlicher Geltungsbereich der Abrechnung</xs: documentation> </xs: annotation> </xs: simpleType> <xs: restriction base="kh: Abrechnungsart"/> </xs: simpleType> </xs: attribute> </pre>												

attribute Begutachtung/Stellungnahme/@fall_ID

type	restriction of Fall_ID									
properties	use optional									
facets	<table border="1"> <thead> <tr> <th>Kind</th> <th>Value</th> <th>Annotation</th> </tr> </thead> <tbody> <tr> <td>minLength</td> <td>1</td> <td></td> </tr> <tr> <td>maxLength</td> <td>15</td> <td></td> </tr> </tbody> </table>	Kind	Value	Annotation	minLength	1		maxLength	15	
Kind	Value	Annotation								
minLength	1									
maxLength	15									
annotation	documentation GKH02: Fall-ID KH (Aufnahmenummer)									
source	<pre><xs:attribute name="fall_ID" use="optional"> <xs:annotation> <xs:documentation>GKH02: Fall-ID KH (Aufnahmenummer)</xs:documentation> </xs:annotation> <xs:simpleType> <xs:restriction base="kh:fall_ID"> <xs:minLength value="1"/> </xs:restriction> </xs:simpleType> </xs:attribute></pre>									

attribute Begutachtung/Stellungnahme/@erledigungsart

type	restriction of Gutachtenart																								
properties	use required																								
facets	<table border="1"> <thead> <tr> <th>Kind</th> <th>Value</th> <th>Annotation</th> </tr> </thead> <tbody> <tr> <td>enumeration</td> <td>01</td> <td></td> </tr> <tr> <td>enumeration</td> <td>02</td> <td></td> </tr> <tr> <td>enumeration</td> <td>03</td> <td></td> </tr> <tr> <td>enumeration</td> <td>04</td> <td></td> </tr> <tr> <td>enumeration</td> <td>05</td> <td></td> </tr> <tr> <td>enumeration</td> <td>06</td> <td></td> </tr> <tr> <td>enumeration</td> <td>07</td> <td></td> </tr> </tbody> </table>	Kind	Value	Annotation	enumeration	01		enumeration	02		enumeration	03		enumeration	04		enumeration	05		enumeration	06		enumeration	07	
Kind	Value	Annotation																							
enumeration	01																								
enumeration	02																								
enumeration	03																								
enumeration	04																								
enumeration	05																								
enumeration	06																								
enumeration	07																								
annotation	documentation GKH03: Erledigungsart																								
source	<pre><xs:attribute name="erledigungsart" use="required"> <xs:annotation> <xs:documentation>GKH03: Erledigungsart</xs:documentation> </xs:annotation> <xs:simpleType> <xs:restriction base="kh:Gutachtenart"/> </xs:simpleType> </xs:attribute></pre>																								

attribute Begutachtung/Stellungnahme/@anlagen_PDF

type	restriction of xs:string			
properties	use required			
facets	<table border="1"> <thead> <tr> <th>Kind</th> <th>Value</th> <th>Annotation</th> </tr> </thead> <tbody> </tbody> </table>	Kind	Value	Annotation
Kind	Value	Annotation		

	length 1 pattern [0-9]
annotation	documentation GKH04: Anzahl der Anlagen
source	<xs:attribute name="anlagen_PDF" use="required"> <xs:annotation> <xs:documentation>GKH04: Anzahl der Anlagen</xs:documentation> </xs:annotation> <xs:simpleType> <xs:restriction base="xs:string"> <xs:length value="1"/> <xs:pattern value="[0-9]"/> </xs:restriction> </xs:simpleType> </xs:attribute>

attribute Begutachtung/Stellungnahme/@anlagen_post

type	restriction of xs:string
properties	use required
facets	Kind Value Annotation length 1 pattern [0-9]
annotation	documentation GKH05: Anzahl der Anlagen per Postweg
source	<xs:attribute name="anlagen_post" use="required"> <xs:annotation> <xs:documentation>GKH05: Anzahl der Anlagen per Postweg</xs:documentation> </xs:annotation> <xs:simpleType> <xs:restriction base="xs:string"> <xs:length value="1"/> <xs:pattern value="[0-9]"/> </xs:restriction> </xs:simpleType> </xs:attribute>

attribute Begutachtung/Stellungnahme/@anlagen_post_text

type	Freitext Mit Zeichen Stp
properties	use optional
facets	Kind Value Annotation minLength 1 maxLength 255
annotation	documentation GKH06: Erläuterung Anlagen per Postweg
source	<xs:attribute name="anlagen_post_text" type="md:Freitext_Mit_Zeichen_Stp" use="optional"> <xs:annotation>

	<pre><xs:documentation>GKH06: Erläuterung Anlagen per Postweg</xs:documentation> </xs:annotation> </xs:attribute></pre>
--	---

attribute Begutachtung/Stellungnahme/@gutachten_auswahl

type	restriction of xs:string									
properties	use required									
facets	<table border="1"> <thead> <tr> <th>Kind</th> <th>Value</th> <th>Annotation</th> </tr> </thead> <tbody> <tr> <td>enumeration</td> <td>0</td> <td></td> </tr> <tr> <td>enumeration</td> <td>1</td> <td></td> </tr> </tbody> </table>	Kind	Value	Annotation	enumeration	0		enumeration	1	
Kind	Value	Annotation								
enumeration	0									
enumeration	1									
annotation	<pre>documentation GKH07: Auswahl zur Begutachtung 0=nein 1=ja</pre>									
source	<pre><xs:attribute name="gutachten_auswahl" use="required"> <xs:annotation> <xs:documentation>GKH07: Auswahl zur Begutachtung 0=nein 1=ja</xs:documentation> </xs:annotation> <xs:simpleType> <xs:restriction base="xs:string"> <xs:enumeration value="0"/> <xs:enumeration value="1"/> </xs:restriction> </xs:simpleType> </xs:attribute></pre>									

attribute Begutachtung/Stellungnahme/@rueckgabe

type	Rueckgabegrund																																				
properties	use optional																																				
facets	<table border="1"> <thead> <tr> <th>Kind</th> <th>Value</th> <th>Annotation</th> </tr> </thead> <tbody> <tr><td>enumeration</td><td>1</td><td></td></tr> <tr><td>enumeration</td><td>3</td><td></td></tr> <tr><td>enumeration</td><td>4</td><td></td></tr> <tr><td>enumeration</td><td>5</td><td></td></tr> <tr><td>enumeration</td><td>6</td><td></td></tr> <tr><td>enumeration</td><td>7</td><td></td></tr> <tr><td>enumeration</td><td>8</td><td></td></tr> <tr><td>enumeration</td><td>9</td><td></td></tr> <tr><td>enumeration</td><td>10</td><td></td></tr> <tr><td>enumeration</td><td>11</td><td></td></tr> <tr><td>enumeration</td><td>12</td><td></td></tr> </tbody> </table>	Kind	Value	Annotation	enumeration	1		enumeration	3		enumeration	4		enumeration	5		enumeration	6		enumeration	7		enumeration	8		enumeration	9		enumeration	10		enumeration	11		enumeration	12	
Kind	Value	Annotation																																			
enumeration	1																																				
enumeration	3																																				
enumeration	4																																				
enumeration	5																																				
enumeration	6																																				
enumeration	7																																				
enumeration	8																																				
enumeration	9																																				
enumeration	10																																				
enumeration	11																																				
enumeration	12																																				
annotation	<pre>documentation GKH08: Rückgabegrund ohne Auftragserledigung</pre>																																				
source	<pre><xs:attribute name="rueckgabe" type="kh:Rueckgabegrund" use="optional"> <xs:annotation> <xs:documentation>GKH08: Rückgabegrund ohne Auftragserledigung</xs:documentation></pre>																																				

	<pre></xs: annotation> </xs: attribute></pre>
--	---

attribute Begutachtung/Stellungnahme/@erlaeuterung_rueckgabe

type	Freitext 1024									
properties	use optional									
facets	<table border="1"> <thead> <tr> <th>Kind</th> <th>Value</th> <th>Annotation</th> </tr> </thead> <tbody> <tr> <td>minLength</td> <td>1</td> <td></td> </tr> <tr> <td>maxLength</td> <td>1024</td> <td></td> </tr> </tbody> </table>	Kind	Value	Annotation	minLength	1		maxLength	1024	
Kind	Value	Annotation								
minLength	1									
maxLength	1024									
annotation	documentation GKH09: Erläuterung Rückgabegrund 'sonstiges'									
source	<pre><xs: attribute name="erlaeuterung_rueckgabe" type="kh: Freitext_1024" use="optional"> <xs: annotation> <xs: documentation>GKH09: Erläuterung Rückgabegrund 'sonstiges' </xs: documentation> </xs: annotation> </xs: attribute></pre>									

attribute Begutachtung/Stellungnahme/@ber_erw_fragestellung

type	Ber_Erw_Fragestellung						
properties	use required						
facets	<table border="1"> <thead> <tr> <th>Kind</th> <th>Value</th> <th>Annotation</th> </tr> </thead> <tbody> <tr> <td>enumeration</td> <td>1</td> <td></td> </tr> </tbody> </table>	Kind	Value	Annotation	enumeration	1	
Kind	Value	Annotation					
enumeration	1						
annotation	documentation GKH10: Berechtigung des MD zur Ergänzung der Fragestellung						
source	<pre><xs: attribute name="ber_erw_fragestellung" type="kh: Ber_Erw_Fragestellung" use="required"> <xs: annotation> <xs: documentation>GKH10: Berechtigung des MD zur Ergänzung der Fragestellung</xs: documentation> </xs: annotation> </xs: attribute></pre>						

attribute Begutachtung/Stellungnahme/@wechsel_auftragsart

type	Wechsel_Auftragsart						
properties	use required						
facets	<table border="1"> <thead> <tr> <th>Kind</th> <th>Value</th> <th>Annotation</th> </tr> </thead> <tbody> <tr> <td>enumeration</td> <td>0</td> <td></td> </tr> </tbody> </table>	Kind	Value	Annotation	enumeration	0	
Kind	Value	Annotation					
enumeration	0						
annotation	documentation GKH11: Berechtigung des MD zum Wechsel der Auftragsart						
source	<pre><xs: attribute name="wechsel_auftragsart" type="kh: Wechsel_Auftragsart" use="required"> <xs: annotation></pre>						

	<pre> <xs:documentation>GKH11: Berechtigung des MD zum Wechsel der Auftragsart</xs:documentation> </xs:annotation> </xs:attribute> </pre>
--	---

attribute Begutachtung/Stellungnahme/@art_begutachtung

type	Art_Begutachtung									
properties	use required									
facets	<table border="1"> <thead> <tr> <th>Kind</th> <th>Value</th> <th>Annotation</th> </tr> </thead> <tbody> <tr> <td>enumeration</td> <td>1</td> <td></td> </tr> <tr> <td>enumeration</td> <td>2</td> <td></td> </tr> </tbody> </table>	Kind	Value	Annotation	enumeration	1		enumeration	2	
Kind	Value	Annotation								
enumeration	1									
enumeration	2									
annotation	documentation GKH12: Art der Begutachtung									
source	<pre> <xs:attribute name="art_begutachtung" type="kh: Art_Begutachtung" use="required"> <xs:annotation> <xs:documentation>GKH12: Art der Begutachtung</xs:documentation> </xs:annotation> </xs:attribute> </pre>									

attribute Begutachtung/Stellungnahme/@datum_unterlagenanforderung

type	Datum_Stp									
properties	use optional									
facets	<table border="1"> <thead> <tr> <th>Kind</th> <th>Value</th> <th>Annotation</th> </tr> </thead> <tbody> <tr> <td>minInclusive</td> <td>1850-01-01</td> <td></td> </tr> <tr> <td>maxInclusive</td> <td>2099-12-31</td> <td></td> </tr> </tbody> </table>	Kind	Value	Annotation	minInclusive	1850-01-01		maxInclusive	2099-12-31	
Kind	Value	Annotation								
minInclusive	1850-01-01									
maxInclusive	2099-12-31									
annotation	documentation GKH13: Datum der Unterlagenanforderung									
source	<pre> <xs:attribute name="datum_unterlagenanforderung" type="md: Datum_Stp" use="optional"> <xs:annotation> <xs:documentation>GKH13: Datum der Unterlagenanforderung</xs:documentation> </xs:annotation> </xs:attribute> </pre>									

element Begutachtung/Stellungnahme/Antworten

diagram						
namespace	http://www.aok-systems.de/xml-schema/mdk-kh-standard_V07.00					
type	CT_Antworten					
properties	minOcc	0	maxOcc	1	content	complex
children	antwort					
identity constraints	unique	Name	key_antwort	Refer	Selector	antwort
					Field(s)	@frage_ID
annotation	documentation GRK-Satz					
source	<pre> <xs:element name="Antworten" type="kh:CT_Antworten" minOccurs="0"> <xs:annotation> <xs:documentation>GRK-Satz</xs:documentation> </xs:annotation> <xs:unique name="key_antwort"> <xs:selector xpath="antwort"/> <xs:field xpath="@frage_ID"/> </xs:unique> </xs:element> </pre>					

element Begutachtung/Stellungnahme/Pruefung

<p>diagram</p>	
<p>namespace</p>	<p>http://www.aok-systems.de/xml-schema/mdk-kh-standard_V07.00</p>
<p>properties</p>	<p>content complex</p>
<p>children</p>	<p>Falldaten Diagnosen Prozeduren Entlassung Entgelte Aktenzeichen anderer Begutachtungsfall Angef. Gelief. Unterlagen</p>
<p>annotation</p>	<p>documentation Notwendige Informationen und Prüfungen</p>
<p>source</p>	<pre> <xs:element name="Pruefung"> <xs:annotation> <xs:documentation>Notwendige Informationen und Prüfungen</xs:documentation> </xs:annotation> <xs:complexType> <xs:sequence> <xs:element name="Falldaten"> <xs:annotation> <xs:documentation>GFK-Satz</xs:documentation> </xs:annotation> <xs:complexType> <xs:sequence> <xs:element name="Aufnahme"> <xs:annotation> <xs:documentation>GFK01 und GFK02</xs:documentation> </xs:annotation> <xs:complexType> <xs:attribute name="aufnahmegrund" type="kh:Aufnahmegrund" use="required"> </xs:complexType> </xs:element> </xs:sequence> </xs:complexType> </xs:element> </xs:sequence> </xs:complexType> </pre>

```

        <xs:documentati on>GFK01: Aufnahmegrund</xs:documentati on>
        </xs:annotati on>
    </xs:attribu te>
    <xs:attribu te name="aufnahmeanl ass" type="kh: Aufnahmeanl ass"
use="requi red">
        <xs:annotati on>
        <xs:documentati on>GFK02: Aufnahmeanl ass </xs:documentati on>
        </xs:annotati on>
        </xs:attribu te>
        </xs:compl exType>
    </xs:el ement>
    <xs:el ement name="Entl assung" type="md: Datum_Stp" mi n0ccurs="0">
        <xs:annotati on>
        <xs:documentati on>GFK03: Voraussi chtl iches Entl assungsdatum im
Format (JJJJ-MM-TT)</xs:documentati on>
        </xs:annotati on>
    </xs:el ement>
    <xs:el ement name="Gewi cht" mi n0ccurs="0">
        <xs:annotati on>
        <xs:documentati on>GFK04: Aufnahmewi cht in
Gramm</xs:documentati on>
        </xs:annotati on>
        <xs:simpl eType>
            <xs:restri cti on base="xs: i nt">
                <xs:mi nI ncl usi ve val ue="0"/>
                <xs:ma xI ncl usi ve val ue="99999"/>
            </xs:restri cti on>
        </xs:simpl eType>
    </xs:el ement>
    </xs:sequen ce>
    </xs:compl exType>
</xs:el ement>
<xs:el ement name="Di agnosen">
    <xs:annotati on>
    <xs:documentati on>GDI -Satz und GFK05</xs:documentati on>
    </xs:annotati on>
    <xs:compl exType>
    <xs:sequen ce>
        <xs:el ement name="Di agnose" ma x0ccurs="999">
            <xs:annotati on>
            <xs:documentati on>GDI -Sätze</xs:documentati on>
            </xs:annotati on>
            <xs:compl exType>
            <xs:sequen ce>
                <xs:el ement name="KH">
                    <xs:annotati on>
                    <xs:documentati on>GDI 01-GDI 03</xs:documentati on>
                    </xs:annotati on>
                    <xs:compl exType>
                    <xs:attribu te name="di agnosetyp" type="kh: Di agnosetyp"
use="requi red">
                        <xs:annotati on>
                        <xs:documentati on>GDI 01:
Di agnosetyp</xs:documentati on>
                        </xs:annotati on>

```

```

        </xs: attribute>
        <xs: attribute name="i cd" use="optional ">
          <xs: annotation>
            <xs: documentation>GDI 02:
ICD-Schlüssel </xs: documentation>
          </xs: annotation>
          <xs: simpleType>
            <xs: restriction base="md: ICD_Schlüssel_Stp" />
          </xs: simpleType>
        </xs: attribute>
        <xs: attribute name="lokalisation"
type="md: Lokalisation_Stp" use="optional ">
          <xs: annotation>
            <xs: documentation>GDI 03:
Lokalisation</xs: documentation>
          </xs: annotation>
          </xs: attribute>
          </xs: complexType>
        </xs: element>
        <xs: element name="MD">
          <xs: annotation>
            <xs: documentation>GDI 04-GDI 07</xs: documentation>
          </xs: annotation>
          <xs: complexType>
            <xs: attribute name="i cd" use="optional ">
              <xs: annotation>
                <xs: documentation>GDI 04:
ICD-Schlüssel </xs: documentation>
              </xs: annotation>
              <xs: simpleType>
                <xs: restriction base="md: ICD_Schlüssel_Stp" />
              </xs: simpleType>
            </xs: attribute>
            <xs: attribute name="lokalisation"
type="md: Lokalisation_Stp" use="optional ">
              <xs: annotation>
                <xs: documentation>GDI 05:
Lokalisation</xs: documentation>
              </xs: annotation>
              </xs: attribute>
            <xs: attribute name="antwort" type="kh: Antwortzeichen"
use="required">
              <xs: annotation>
                <xs: documentation>GDI 06: Antwort MD</xs: documentation>
              </xs: annotation>
            </xs: attribute>
            <xs: attribute name="erläuterung" type="kh: Freitext_1024"
use="optional ">
              <xs: annotation>
                <xs: documentation>GDI 07: Erläuterungen
MD</xs: documentation>
              </xs: annotation>
            </xs: attribute>
          </xs: complexType>
        </xs: element>

```

```

        </xs: sequence>
    </xs: complexType>
</xs: element>
</xs: sequence>
<xs: attribute name="icd_version" use="required">
    <xs: annotation>
        <xs: documentation>GFK05: ICD-Version</xs: documentation>
    </xs: annotation>
    <xs: simpleType>
        <xs: restriction base="xs:gYear">
            <xs: minOccurs value="2003"/>
            <xs: maxInclusive value="2099"/>
        </xs: restriction>
    </xs: simpleType>
</xs: attribute>
</xs: complexType>
</xs: element>
<xs: element name="Prozeduren" minOccurs="0">
    <xs: annotation>
        <xs: documentation>GOP-Satz und GFK06</xs: documentation>
    </xs: annotation>
    <xs: complexType>
        <xs: sequence>
            <xs: element name="Prozedur" maxOccurs="999">
                <xs: annotation>
                    <xs: documentation>GOP-Sätze</xs: documentation>
                </xs: annotation>
                <xs: complexType>
                    <xs: sequence>
                        <xs: element name="KH">
                            <xs: annotation>
                                <xs: documentation>GOP01-03</xs: documentation>
                            </xs: annotation>
                            <xs: complexType>
                                <xs: attribute name="ops" use="optional">
                                    <xs: annotation>
                                        <xs: documentation>GOP01:
OPS-Schlüssel </xs: documentation>
                                        </xs: annotation>
                                    </xs: simpleType>
                                <xs: restriction base="kh:OPS_Schlüssel"/>
                            </xs: simpleType>
                        </xs: attribute>
                        <xs: attribute name="Lokalisation"
type="md:Lokalisation_Stp" use="optional">
                            <xs: annotation>
                                <xs: documentation>GOP02:
Lokalisation</xs: documentation>
                            </xs: annotation>
                        </xs: attribute>
                        <xs: attribute name="datum_ops" type="md:Datum_Stp"
use="optional">
                            <xs: annotation>
                                <xs: documentation>GOP03: Datum OPS im Format
(JJJJ-MM-TT)</xs: documentation>

```

```

        </xs: annotation>
        </xs: attribute>
    </xs: complexType>
</xs: element>
<xs: element name="MD">
    <xs: annotation>
        <xs: documentation>GOP04-08</xs: documentation>
    </xs: annotation>
    <xs: complexType>
        <xs: attribute name="ops" type="kh: OPS_Schl uessel "
use="optional ">
            <xs: annotation>
                <xs: documentation>GOP04: OPS-Schl üssel
MD</xs: documentation>
            </xs: annotation>
            </xs: attribute>
            <xs: attribute name="Lokal isati on"
type="md: Lokal isati on_Stp" use="optional ">
                <xs: annotation>
                    <xs: documentation>GOP05: Lokal isati on
MD</xs: documentation>
                </xs: annotation>
                </xs: attribute>
                <xs: attribute name="datum_ops" type="md: Datum_Stp"
use="optional ">
                    <xs: annotation>
                        <xs: documentation>GOP06: Datum OPS MD im Format
(JJJJ-MM-TT)</xs: documentation>
                    </xs: annotation>
                    </xs: attribute>
                    <xs: attribute name="antwort" type="kh: Antwortzei chen"
use="required">
                        <xs: annotation>
                            <xs: documentation>GOP07: Antwort MD</xs: documentation>
                        </xs: annotation>
                        </xs: attribute>
                        <xs: attribute name="erl aeuterung" type="kh: Frei text_1024"
use="optional ">
                            <xs: annotation>
                                <xs: documentation>GOP08: Erl äuterungen
MD</xs: documentation>
                            </xs: annotation>
                            </xs: attribute>
                            </xs: complexType>
                            </xs: element>
                            </xs: sequence>
                            </xs: complexType>
                            </xs: element>
                            </xs: sequence>
                            <xs: attribute name="ops_versi on" use="required">
                                <xs: annotation>
                                    <xs: documentation>GFK06: OPS-Versi on</xs: documentation>
                                </xs: annotation>
                                <xs: simpleType>
                                    <xs: restricti on base="xs: gYear">

```

```

        <xs:mi nI ncl usi ve val ue="2003"/>
        <xs:ma xI ncl usi ve val ue="2099"/>
    </xs:re stri cti on>
</xs:si mpl eType>
</xs:at tri bute>
</xs:com pl exType>
</xs:el ement>
<xs:el ement name="Entl assung" mi nOccurs="0">
    <xs:annotati on>
        <xs:documentati on>GEK-Satz</xs:documentati on>
    </xs:annotati on>
    <xs:com pl exType>
        <xs:sequence>
            <xs:el ement name="Abtei lungstyp" type="md: Abtei lungstyp_Stp"
mi nOccurs="0">
                <xs:annotati on>
                    <xs:documentati on>GEK01: Zusatzschlüssel Abtei lungstyp
MD</xs:documentati on>
                </xs:annotati on>
            </xs:el ement>
            <xs:el ement name="Entl assungsgrund" type="kh: Entl assungsgrund">
                <xs:annotati on>
                    <xs:documentati on>GEK02: Grund der Entl assung/ Verle gung
MD</xs:documentati on>
                </xs:annotati on>
            </xs:el ement>
            <xs:choi ce>
                <xs:sequence>
                    <xs:el ement name="MD_DRG" mi nOccurs="0">
                        <xs:annotati on>
                            <xs:documentati on>GEK03-04</xs:documentati on>
                        </xs:annotati on>
                    <xs:com pl exType>
                        <xs:at tri bute name="DRG" use="opti onal ">
                            <xs:annotati on>
                                <xs:documentati on>GEK03: DRG-MD</xs:documentati on>
                            </xs:annotati on>
                            <xs:si mpl eType>
                                <xs:re stri cti on base="kh: DRG"/>
                            </xs:si mpl eType>
                        </xs:at tri bute>
                        <xs:at tri bute name="rel ati vgewi cht" use="opti onal ">
                            <xs:annotati on>
                                <xs:documentati on>GEK04: Eff. Rel ati vgewi cht der
DRG-MD</xs:documentati on>
                            </xs:annotati on>
                            <xs:si mpl eType>
                                <xs:re stri cti on base="xs: deci mal ">
                                    <xs:total Di gi ts val ue="8"/>
                                    <xs:fracti onDi gi ts val ue="3"/>
                                    <xs:ma xExcl usi ve val ue="100000"/>
                                </xs:re stri cti on>
                            </xs:si mpl eType>
                        </xs:at tri bute>
                    </xs:com pl exType>
                </xs:sequence>
            </xs:choi ce>
        </xs:sequence>
    </xs:com pl exType>
</xs:el ement>

```

```

</xs:element>
</xs:sequence>
<xs:sequence>
  <xs:element name="MD_PEPP" minOccurs="0">
    <xs:annotation>
      <xs:documentation>GEK09: PEPP MD</xs:documentation>
    </xs:annotation>
    <xs:simpleType>
      <xs:restriction base="xs:string">
        <xs:maxLength value="5"/>
        <xs:minLength value="1"/>
      </xs:restriction>
    </xs:simpleType>
  </xs:element>
  <xs:element name="Bewertungsrelation" minOccurs="0">
    <xs:annotation>
      <xs:documentation>GEK10: Eff. Bewertungsrelation der PEPP
MD</xs:documentation>
    </xs:annotation>
    <xs:simpleType>
      <xs:restriction base="xs:decimal">
        <xs:totalDigits value="8"/>
        <xs:fractionDigits value="4"/>
        <xs:maxExclusive value="10000"/>
      </xs:restriction>
    </xs:simpleType>
  </xs:element>
</xs:sequence>
</xs:choice>
<xs:element name="Beatmungsstunden" minOccurs="0">
  <xs:annotation>
    <xs:documentation>GEK05: Anzahl
Beatmungsstunden</xs:documentation>
  </xs:annotation>
  <xs:simpleType>
    <xs:restriction base="xs:int">
      <xs:minInclusive value="0"/>
      <xs:maxInclusive value="9999"/>
    </xs:restriction>
  </xs:simpleType>
</xs:element>
<xs:element name="Entbindung" minOccurs="0" maxOccurs="2">
  <xs:annotation>
    <xs:documentation>GEK06-07: Tag der Entbindung MD im Format
(JJJJ-MM-TT)</xs:documentation>
  </xs:annotation>
  <xs:simpleType>
    <xs:restriction base="md:Datum_Stp"/>
  </xs:simpleType>
</xs:element>
<xs:element name="TOB" type="kh:Anzahl_Tage3" minOccurs="0">
  <xs:annotation>
    <xs:documentation>GEK08: Tage ohne Berechnung
(TOB)</xs:documentation>
  </xs:annotation>

```

```

        </xs:element>
    </xs:sequence>
</xs:complexType>
</xs:element>
<xs:element name="Entgelte" minOccurs="0" maxOccurs="999">
    <xs:annotation>
        <xs:documentation>GEG-Sätze</xs:documentation>
    </xs:annotation>
    <xs:complexType>
        <xs:sequence>
            <xs:element name="KH">
                <xs:annotation>
                    <xs:documentation>GEG01-06</xs:documentation>
                </xs:annotation>
                <xs:complexType>
                    <xs:attribute name="entgeltart" type="kh:Entgeltart"
use="optional">
                        <xs:annotation>
                            <xs:documentation>GEG01: Entgeltart</xs:documentation>
                        </xs:annotation>
                    </xs:attribute>
                    <xs:attribute name="betrag" use="optional">
                        <xs:annotation>
                            <xs:documentation>GEG02: Entgeltbetrag </xs:documentation>
                        </xs:annotation>
                        <xs:simpleType>
                            <xs:restriction base="xs:decimal">
                                <xs:fractionDigits value="2" fixed="false"/>
                                <xs:totalDigits value="9"/>
                                <xs:maxExclusive value="100000000"/>
                            </xs:restriction>
                        </xs:simpleType>
                    </xs:attribute>
                    <xs:attribute name="abrechnung_von" type="md:Datum_Stp"
use="optional">
                        <xs:annotation>
                            <xs:documentation>GEG03: Entgelt Abrechnung von im
Format(JJJJ-MM-TT)</xs:documentation>
                        </xs:annotation>
                    </xs:attribute>
                    <xs:attribute name="abrechnung_bis" type="md:Datum_Stp"
use="optional">
                        <xs:annotation>
                            <xs:documentation>GEG04: Entgelt Abrechnung bis im
Format(JJJJ-MM-TT)</xs:documentation>
                        </xs:annotation>
                    </xs:attribute>
                    <xs:attribute name="entgelt_anzahl" type="kh:Anzahl_Tage3"
use="optional">
                        <xs:annotation>
                            <xs:documentation>GEG05: Anzahl des
Entgeltschlüssels</xs:documentation>
                        </xs:annotation>
                    </xs:attribute>
                    <xs:attribute name="TOB" type="kh:Anzahl_Tage3" use="optional">

```



```

        <xs: annotation>
        <xs: documentation>GEG06: Tage ohne
Berechnung/Behandlung</xs: documentation>
        </xs: annotation>
        </xs: attribute>
        </xs: complexType>
</xs: element>
<xs: element name="MD">
        <xs: annotation>
        <xs: documentation>GEG07-14</xs: documentation>
        </xs: annotation>
        <xs: complexType>
        <xs: attribute name="entgeltart" type="kh: Entgeltart"
use="optional">
        <xs: annotation>
        <xs: documentation>GEG07: Entgeltart MD</xs: documentation>
        </xs: annotation>
        </xs: attribute>
        <xs: attribute name="betrag" use="optional">
        <xs: annotation>
        <xs: documentation>GEG08: Entgeltbetrag MD</xs: documentation>
        </xs: annotation>
        <xs: simpleType>
        <xs: restriction base="xs: decimal">
        <xs: fractionDigits value="2" fixed="false"/>
        <xs: totalDigits value="9"/>
        <xs: maxExclusive value="100000000"/>
        </xs: restriction>
        </xs: simpleType>
        </xs: attribute>
        <xs: attribute name="abrechnung_von" type="md: Datum_Stp"
use="optional">
        <xs: annotation>
        <xs: documentation>GEG09: Entgelt Abrechnung von MD im Format
(JJJJ-MM-TT)</xs: documentation>
        </xs: annotation>
        </xs: attribute>
        <xs: attribute name="abrechnung_bis" type="md: Datum_Stp"
use="optional">
        <xs: annotation>
        <xs: documentation>GEG10: Entgelt Abrechnung bis MD im Format
(JJJJ-MM-TT)</xs: documentation>
        </xs: annotation>
        </xs: attribute>
        <xs: attribute name="entgelt_anzahl" type="kh: Anzahl_Tage3"
use="optional">
        <xs: annotation>
        <xs: documentation>GEG11: Anzahl des Entgeltschlüssels
MD</xs: documentation>
        </xs: annotation>
        </xs: attribute>
        <xs: attribute name="TOB" type="kh: Anzahl_Tage3" use="optional">
        <xs: annotation>
        <xs: documentation>GEG12: Tage ohne Berechnung/Behandlung
MD</xs: documentation>

```

```

        </xs: annotation>
        </xs: attribute>
        <xs: attribute name="antwort" type="kh: Antwortzeichen"
use="required">
        <xs: annotation>
        <xs: documentation>GEG13: Antwort MD</xs: documentation>
        </xs: annotation>
        </xs: attribute>
        <xs: attribute name="erlaeuterung" type="kh: Freitext_1024"
use="optional">
        <xs: annotation>
        <xs: documentation>GEG14: Erläuterungen MD</xs: documentation>
        </xs: annotation>
        </xs: attribute>
        </xs: complexType>
        </xs: element>
    </xs: sequence>
</xs: complexType>
</xs: element>
<xs: element name="Aktenzeichen_anderer_Begutachtungsfall"
type="md: Aktenzeichen_anderer_Begutachtungsfall_Ctp" minOccurs="0" maxOccurs="9">
    <xs: annotation>
    <xs: documentation>AAB: Aktenzeichen anderer
Begutachtungsfall</xs: documentation>
    </xs: annotation>
    </xs: element>
    <xs: element name="Angef_Geliefert_Unterlagen" minOccurs="0" maxOccurs="9999">
    <xs: annotation>
    <xs: documentation>AGU-Sätze</xs: documentation>
    </xs: annotation>
    <xs: complexType>
    <xs: sequence>
    <xs: element name="Unterlagen_Bezeichnung" type="kh: Freitext_1024"
minOccurs="1">
    <xs: annotation>
    <xs: documentation>AGU01: Unterlagen
Bezeichnung</xs: documentation>
    </xs: annotation>
    </xs: element>
    <xs: element name="Datum_Anforderung" type="md: Datum_Stp"
minOccurs="0">
    <xs: annotation>
    <xs: documentation>AGU02: Datum der Anforderung im Format
(JJJJ-MM-TT)</xs: documentation>
    </xs: annotation>
    </xs: element>
    <xs: element name="Bereitstellung" type="kh: Bereitstellung_Unterlagen"
minOccurs="1">
    <xs: annotation>
    <xs: documentation>AGU03: Bereitstellung (Schlüssel
U)</xs: documentation>
    </xs: annotation>
    </xs: element>
    <xs: element name="Dokumententyp" minOccurs="1">
    <xs: annotation>

```

```

        <xs:documentation>AGU04: Dokumententyp nach
eVV</xs:documentation>
    </xs:annotation>
    <xs:simpleType>
        <xs:restriction base="xs:string">
            <xs:length value="8"/>
        </xs:restriction>
    </xs:simpleType>
    </xs:element>
    <xs:element name="Datum_Bereitstellung" type="md:Datum_Stp"
mi nOccurs="0">
        <xs:annotation>
            <xs:documentation>AGU05: Datum der Bereit stellung im Format
(JJJJ-MM-TT)</xs:documentation>
        </xs:annotation>
    </xs:element>
    <xs:element name="Hashwert" mi nOccurs="0">
        <xs:annotation>
            <xs:documentation>AGU06: Hashwert I t.
MD-Portal </xs:documentation>
        </xs:annotation>
    <xs:simpleType>
        <xs:restriction base="xs:string">
            <xs:length value="32"/>
        </xs:restriction>
    </xs:simpleType>
    </xs:element>
    <xs:element name="Anmerkungen" type="kh:Frei text_1024" mi nOccurs="0">
        <xs:annotation>
            <xs:documentation>AGU07: Anmerkungen</xs:documentation>
        </xs:annotation>
    </xs:element>
</xs:sequence>
</xs:complexType>
</xs:element>
</xs:sequence>
</xs:complexType>
</xs:element>

```

element Begutachtung/Stellungnahme/Pruefung/Falldaten

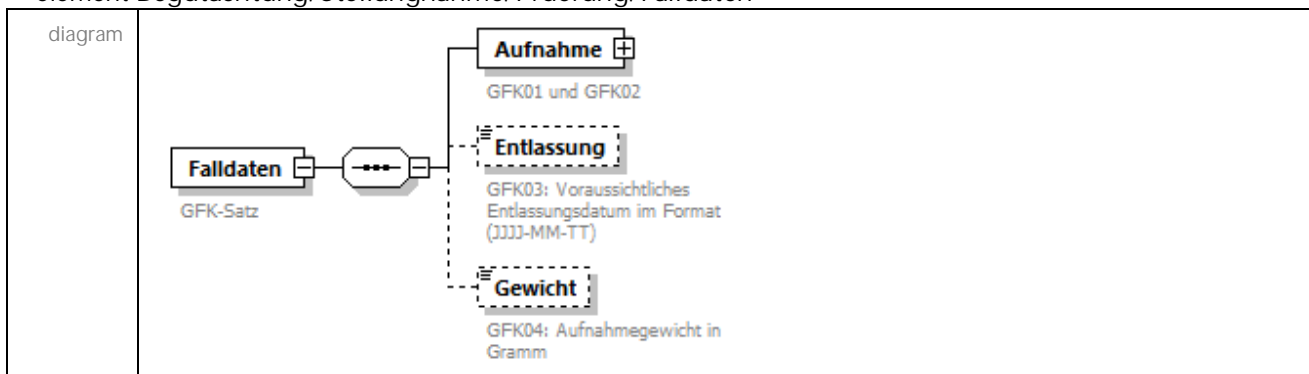

namespace	http://www.aok-systems.de/xml-schema/mdk-kh-standard_V07.00
properties	content complex
children	Aufnahme Entlassung Gewicht
annotation	documentation GFK-Satz
source	<pre> <xs:element name="FallDaten"> <xs:annotation> <xs:documentation>GFK-Satz</xs:documentation> </xs:annotation> <xs:complexType> <xs:sequence> <xs:element name="Aufnahme"> <xs:annotation> <xs:documentation>GFK01 und GFK02</xs:documentation> </xs:annotation> <xs:complexType> <xs:attribute name="aufnahmegrund" type="kh:Aufnahmegrund" use="required"> <xs:annotation> <xs:documentation>GFK01: Aufnahmegrund</xs:documentation> </xs:annotation> </xs:attribute> <xs:attribute name="aufnahmeanlass" type="kh:Aufnahmeanlass" use="required"> <xs:annotation> <xs:documentation>GFK02: Aufnahmeanlass </xs:documentation> </xs:annotation> </xs:attribute> </xs:complexType> </xs:element> <xs:element name="Entlassung" type="md:Datum_Stp" minOccurs="0"> <xs:annotation> <xs:documentation>GFK03: Voraussichtliches Entlassungsdatum im Format (JJJJ-MM-TT)</xs:documentation> </xs:annotation> </xs:element> <xs:element name="Gewicht" minOccurs="0"> <xs:annotation> <xs:documentation>GFK04: Aufnahmegewicht in Gramm</xs:documentation> </xs:annotation> <xs:simpleType> <xs:restriction base="xs:int"> <xs:minInclusive value="0"/> <xs:maxInclusive value="99999"/> </xs:restriction> </xs:simpleType> </xs:element> </xs:sequence> </xs:complexType> </xs:element> </pre>

element Begutachtung/Stellungnahme/Pruefung/Falldaten/Aufnahme

diagram						
namespace	http://www.aok-systems.de/xml-schema/mdk-kh-standard_V07.00					
properties	content complex					
attributes	Name	Type	Use	Default	Fixed	Annotation
	aufnahmegrund	Aufnahmegrund	required			documentation GFK01: Aufnahmegrund
	aufnahmeanlass	Aufnahmeanlass	required			documentation GFK02: Aufnahmeanlass
annotation	documentation GFK01 und GFK02					
source	<pre> <xs:element name="Aufnahme"> <xs:annotation> <xs:documentation>GFK01 und GFK02</xs:documentation> </xs:annotation> <xs:complexType> <xs:attribute name="aufnahmegrund" type="kh: Aufnahmegrund" use="required"> <xs:annotation> <xs:documentation>GFK01: Aufnahmegrund</xs:documentation> </xs:annotation> </xs:attribute> <xs:attribute name="aufnahmeanlass" type="kh: Aufnahmeanlass" use="required"> <xs:annotation> <xs:documentation>GFK02: Aufnahmeanlass </xs:documentation> </xs:annotation> </xs:attribute> </xs:complexType> </xs:element> </pre>					

attribute Begutachtung/Stellungnahme/Pruefung/Falldaten/Aufnahme/@aufnahmegrund

type	Aufnahmegrund					
properties	use required					
facets	Kind	Value	Annotation			
	length	4				
	pattern	(0[1-9] 10 11)[024][1-8]				
annotation	documentation GFK01: Aufnahmegrund					
source	<pre> <xs:attribute name="aufnahmegrund" type="kh: Aufnahmegrund" use="required"> <xs:annotation> <xs:documentation>GFK01: Aufnahmegrund</xs:documentation> </xs:annotation> </xs:attribute> </pre>					

	<pre></xs: annotation> </xs: attribute></pre>
--	---

attribute Begutachtung/Stellungnahme/Pruefung/Falldaten/Aufnahme/@aufnahmearlass

type	Aufnahmearlass																					
properties	use required																					
facets	<table border="1"> <thead> <tr> <th>Kind</th> <th>Value</th> <th>Annotation</th> </tr> </thead> <tbody> <tr> <td>enumeration</td> <td>E</td> <td></td> </tr> <tr> <td>enumeration</td> <td>Z</td> <td></td> </tr> <tr> <td>enumeration</td> <td>N</td> <td></td> </tr> <tr> <td>enumeration</td> <td>R</td> <td></td> </tr> <tr> <td>enumeration</td> <td>V</td> <td></td> </tr> <tr> <td>enumeration</td> <td>A</td> <td></td> </tr> </tbody> </table>	Kind	Value	Annotation	enumeration	E		enumeration	Z		enumeration	N		enumeration	R		enumeration	V		enumeration	A	
Kind	Value	Annotation																				
enumeration	E																					
enumeration	Z																					
enumeration	N																					
enumeration	R																					
enumeration	V																					
enumeration	A																					
annotation	documentation GFK02: Aufnahmearlass																					
source	<pre><xs: attribute name="aufnahmearlass" type="kh: Aufnahmearlass" use="required"> <xs: annotation> <xs: documentation>GFK02: Aufnahmearlass </xs: documentation> </xs: annotation> </xs: attribute></pre>																					

element Begutachtung/Stellungnahme/Pruefung/Falldaten/Entlassung

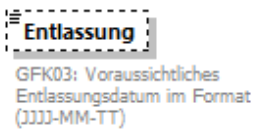
diagram										
namespace	http://www.aok-systems.de/xml-schema/mdk-kh-standard_V07.00									
type	Datum_Stp									
properties	minOcc 0 maxOcc 1 content simple									
facets	<table border="1"> <thead> <tr> <th>Kind</th> <th>Value</th> <th>Annotation</th> </tr> </thead> <tbody> <tr> <td>minInclusive</td> <td>1850-01-01</td> <td></td> </tr> <tr> <td>maxInclusive</td> <td>2099-12-31</td> <td></td> </tr> </tbody> </table>	Kind	Value	Annotation	minInclusive	1850-01-01		maxInclusive	2099-12-31	
Kind	Value	Annotation								
minInclusive	1850-01-01									
maxInclusive	2099-12-31									
annotation	documentation GFK03: Voraussichtliches Entlassungsdatum im Format (JJJJ-MM-TT)									
source	<pre><xs: element name="Entlassung" type="md: Datum_Stp" minOccurs="0"> <xs: annotation> <xs: documentation>GFK03: Voraussichtliches Entlassungsdatum im Format (JJJJ-MM-TT)</xs: documentation> </xs: annotation> </xs: element></pre>									

element Begutachtung/Stellungnahme/Pruefung/Falldaten/Gewicht

diagram										
namespace	http://www.aok-systems.de/xml-schema/mdk-kh-standard_V07.00									
type	restriction of xs:int									
properties	minOcc 0 maxOcc 1 content simple									
facets	<table border="1"> <thead> <tr> <th>Kind</th> <th>Value</th> <th>Annotation</th> </tr> </thead> <tbody> <tr> <td>minInclusive</td> <td>0</td> <td></td> </tr> <tr> <td>maxInclusive</td> <td>99999</td> <td></td> </tr> </tbody> </table>	Kind	Value	Annotation	minInclusive	0		maxInclusive	99999	
Kind	Value	Annotation								
minInclusive	0									
maxInclusive	99999									
annotation	documentation GFK04: Aufnahmegewicht in Gramm									
source	<pre><xs:element name="Gewicht" minOccurs="0"> <xs:annotation> <xs:documentation>GFK04: Aufnahmegewicht in Gramm</xs:documentation> </xs:annotation> <xs:simpleType> <xs:restriction base="xs:int"> <xs:minInclusive value="0"/> <xs:maxInclusive value="99999"/> </xs:restriction> </xs:simpleType> </xs:element></pre>									

element Begutachtung/Stellungnahme/Pruefung/Diagnosen

diagram													
namespace	http://www.aok-systems.de/xml-schema/mdk-kh-standard_V07.00												
properties	content complex												
children	Diagnose												
attributes	<table border="1"> <thead> <tr> <th>Name</th> <th>Type</th> <th>Use</th> <th>Default</th> <th>Fixed</th> <th>Annotation</th> </tr> </thead> <tbody> <tr> <td>icd_version</td> <td>derived by: xs:gYear</td> <td>required</td> <td></td> <td></td> <td>documentation GFK05: ICD-Version</td> </tr> </tbody> </table>	Name	Type	Use	Default	Fixed	Annotation	icd_version	derived by: xs:gYear	required			documentation GFK05: ICD-Version
Name	Type	Use	Default	Fixed	Annotation								
icd_version	derived by: xs:gYear	required			documentation GFK05: ICD-Version								
annotation	documentation GDI-Satz und GFK05												
source	<pre><xs:element name="Diagnosen"> <xs:annotation></pre>												

```

<xs:documentati on>GDI -Satz und GFK05</xs:documentati on>
</xs:annotati on>
<xs:compl exType>
  <xs:sequence>
    <xs:el ement name="Di agnose" maxOccurs="999">
      <xs:annotati on>
        <xs:documentati on>GDI -Sätze</xs:documentati on>
      </xs:annotati on>
    <xs:compl exType>
      <xs:sequence>
        <xs:el ement name="KH">
          <xs:annotati on>
            <xs:documentati on>GDI 01-GDI 03</xs:documentati on>
          </xs:annotati on>
          <xs:compl exType>
            <xs:attri bute name="di agnosetyp" type="kh: Di agnosetyp"
use="requi red">
              <xs:annotati on>
                <xs:documentati on>GDI 01: Di agnosetyp</xs:documentati on>
              </xs:annotati on>
            </xs:attri bute>
            <xs:attri bute name="i cd" use="opti onal ">
              <xs:annotati on>
                <xs:documentati on>GDI 02: I CD-Schl üssel </xs:documentati on>
              </xs:annotati on>
              <xs:simpl eType>
                <xs:restricti on base="md: I CD_Schl uessel _Stp"/>
              </xs:simpl eType>
            </xs:attri bute>
            <xs:attri bute name="l okal i sati on" type="md: Lokal i sati on_Stp"
use="opti onal ">
              <xs:annotati on>
                <xs:documentati on>GDI 03: Lokal i sati on</xs:documentati on>
              </xs:annotati on>
            </xs:attri bute>
          </xs:compl exType>
        </xs:el ement>
        <xs:el ement name="MD">
          <xs:annotati on>
            <xs:documentati on>GDI 04-GDI 07</xs:documentati on>
          </xs:annotati on>
          <xs:compl exType>
            <xs:attri bute name="i cd" use="opti onal ">
              <xs:annotati on>
                <xs:documentati on>GDI 04: I CD-Schl üssel </xs:documentati on>
              </xs:annotati on>
              <xs:simpl eType>
                <xs:restricti on base="md: I CD_Schl uessel _Stp"/>
              </xs:simpl eType>
            </xs:attri bute>
            <xs:attri bute name="l okal i sati on" type="md: Lokal i sati on_Stp"
use="opti onal ">
              <xs:annotati on>
                <xs:documentati on>GDI 05: Lokal i sati on</xs:documentati on>
              </xs:annotati on>
            </xs:attri bute>
          </xs:compl exType>
        </xs:el ement>
      </xs:sequence>
    </xs:el ement>
  </xs:sequence>
</xs:compl exType>

```



```

        </xs: attribute>
        <xs: attribute name="antwort" type="kh: Antwortzeichen"
use="required">
            <xs: annotation>
                <xs: documentation>GDI 06: Antwort MD</xs: documentation>
            </xs: annotation>
        </xs: attribute>
        <xs: attribute name="erlaeuterung" type="kh: Freitext_1024"
use="optional">
            <xs: annotation>
                <xs: documentation>GDI 07: Erläuterungen MD</xs: documentation>
            </xs: annotation>
        </xs: attribute>
    </xs: complexType>
</xs: element>
</xs: sequence>
</xs: complexType>
</xs: element>
</xs: sequence>
<xs: attribute name="icd_version" use="required">
    <xs: annotation>
        <xs: documentation>GFK05: ICD-Version</xs: documentation>
    </xs: annotation>
    <xs: simpleType>
        <xs: restriction base="xs:gYear">
            <xs: minInclusive value="2003"/>
            <xs: maxInclusive value="2099"/>
        </xs: restriction>
    </xs: simpleType>
</xs: attribute>
</xs: complexType>
</xs: element>

```

attribute Begutachtung/Stellungnahme/Pruefung/Diagnosen/@icd_version

type	restriction of xs:gYear									
properties	use required									
facets	<table border="1"> <thead> <tr> <th>Kind</th> <th>Value</th> <th>Annotation</th> </tr> </thead> <tbody> <tr> <td>minInclusive</td> <td>2003</td> <td></td> </tr> <tr> <td>maxInclusive</td> <td>2099</td> <td></td> </tr> </tbody> </table>	Kind	Value	Annotation	minInclusive	2003		maxInclusive	2099	
Kind	Value	Annotation								
minInclusive	2003									
maxInclusive	2099									
annotation	documentation GFK05: ICD-Version									
source	<pre> <xs: attribute name="icd_version" use="required"> <xs: annotation> <xs: documentation>GFK05: ICD-Version</xs: documentation> </xs: annotation> <xs: simpleType> <xs: restriction base="xs:gYear"> <xs: minInclusive value="2003"/> <xs: maxInclusive value="2099"/> </xs: restriction> </xs: simpleType> </pre>									

</xs:attribute>

element Begutachtung/Stellungnahme/Pruefung/Diagnosen/Diagnose

diagram	
namespace	http://www.aok-systems.de/xml-schema/mdk-kh-standard_V07.00
properties	minOcc 1 maxOcc 999 content complex
children	KH MD
annotation	documentation GDI-Sätze
source	<pre><xs:element name="Diagnose" maxOccurs="999"> <xs:annotation> <xs:documentation>GDI -Sätze</xs:documentation> </xs:annotation> <xs:complexType> <xs:sequence> <xs:element name="KH"> <xs:annotation> <xs:documentation>GDI 01 -GDI 03</xs:documentation> </xs:annotation> <xs:complexType> <xs:attribute name="diagnosetyp" type="kh:Diagnosetyp" use="required"> <xs:annotation> <xs:documentation>GDI 01: Diagnosentyp</xs:documentation> </xs:annotation> </xs:attribute> <xs:attribute name="icd" use="optional"> <xs:annotation> <xs:documentation>GDI 02: ICD-Schlüssel</xs:documentation> </xs:annotation> </xs:attribute> <xs:simpleType> <xs:restriction base="md:ICD_Schluessel_Stp"/> </xs:simpleType> <xs:attribute name="Lokalisation" type="md:Lokalisation_Stp" use="optional"> <xs:annotation> <xs:documentation>GDI 03: Lokalisation</xs:documentation> </xs:annotation> </xs:attribute> </xs:complexType> </xs:element> <xs:element name="MD"> <xs:annotation> <xs:documentation>GDI 04-GDI 07</xs:documentation> </xs:annotation> </xs:element> </xs:sequence> </xs:complexType> </xs:element></pre>

```

</xs:annotati on>
<xs:compl exType>
  <xs:attri bute name="i cd" use="opti onal ">
    <xs:annotati on>
      <xs:documentati on>GDI 04: I CD-Schl üssel </xs:documentati on>
    </xs:annotati on>
    <xs:simpl eType>
      <xs:restri cti on base="md: I CD_Schl uessel _Stp" />
    </xs:simpl eType>
  </xs:attri bute>
  <xs:attri bute name="Lokal isati on" type="md: Lokal isati on_Stp"
use="opti onal ">
    <xs:annotati on>
      <xs:documentati on>GDI 05: Lokal isati on</xs:documentati on>
    </xs:annotati on>
  </xs:attri bute>
  <xs:attri bute name="antwort" type="kh: Antwortzei chen" use="requi red">
    <xs:annotati on>
      <xs:documentati on>GDI 06: Antwort MD</xs:documentati on>
    </xs:annotati on>
  </xs:attri bute>
  <xs:attri bute name="erl äuterung" type="kh: Frei text_1024"
use="opti onal ">
    <xs:annotati on>
      <xs:documentati on>GDI 07: Erl äuterungen MD</xs:documentati on>
    </xs:annotati on>
  </xs:attri bute>
</xs:compl exType>
</xs:el ement>
</xs:sequence>
</xs:compl exType>
</xs:el ement>

```

element Begutachtung/Stellungnahme/Pruefung/Diagnosen/Diagnose/KH

diagram						
namespace	http://www.aok-systems.de/xml-schema/mdk-kh-standard_V07.00					
properties	content complex					
attributes	Name	Type	Use	Default	Fixed	Annotation
	diagnosetyp	Diagnosetyp	required			documentation GDI01: Diagnosentyp

	icd derived by: optional documentation ICD_Schluessel_Stp GDI02: lokalisation Lokalisation_Stp optional documentation GDI03: Lokalisation
annotation	documentation GDI01-GDI03
source	<pre> <xs:element name="KH"> <xs:annotation> <xs:documentation>GDI 01-GDI 03</xs:documentation> </xs:annotation> <xs:complexType> <xs:attribute name="diagnosetyp" type="kh:Diagnosetyp" use="required"> <xs:annotation> <xs:documentation>GDI 01: Diagnosentyp</xs:documentation> </xs:annotation> </xs:attribute> <xs:attribute name="icd" use="optional"> <xs:annotation> <xs:documentation>GDI 02: ICD-Schlüssel</xs:documentation> </xs:annotation> </xs:attribute> <xs:simpleType> <xs:restriction base="md:ICD_Schluessel_Stp"/> </xs:simpleType> </xs:attribute> <xs:attribute name="lokalisation" type="md:Lokalisation_Stp" use="optional"> <xs:annotation> <xs:documentation>GDI 03: Lokalisation</xs:documentation> </xs:annotation> </xs:attribute> </xs:complexType> </xs:element> </pre>

attribute Begutachtung/Stellungnahme/Pruefung/Diagnosen/Diagnose/KH/@diagnosetyp

type	Diagnosetyp															
properties	use required															
facets	<table border="1"> <thead> <tr> <th>Kind</th> <th>Value</th> <th>Annotation</th> </tr> </thead> <tbody> <tr> <td>enumeration</td> <td>01</td> <td></td> </tr> <tr> <td>enumeration</td> <td>02</td> <td></td> </tr> <tr> <td>enumeration</td> <td>03</td> <td></td> </tr> <tr> <td>enumeration</td> <td>04</td> <td></td> </tr> </tbody> </table>	Kind	Value	Annotation	enumeration	01		enumeration	02		enumeration	03		enumeration	04	
Kind	Value	Annotation														
enumeration	01															
enumeration	02															
enumeration	03															
enumeration	04															
annotation	documentation GDI01: Diagnosentyp															
source	<pre> <xs:attribute name="diagnosetyp" type="kh:Diagnosetyp" use="required"> <xs:annotation> <xs:documentation>GDI 01: Diagnosentyp</xs:documentation> </xs:annotation> </xs:attribute> </pre>															

attribute Begutachtung/Stellungnahme/Pruefung/Diagnosen/Diagnose/KH/@icd

type	restriction of ICD_Schluesel_Stp												
properties	use optional												
facets	<table border="1"> <thead> <tr> <th>Kind</th> <th>Value</th> <th>Annotation</th> </tr> </thead> <tbody> <tr> <td>minLength</td> <td>3</td> <td></td> </tr> <tr> <td>maxLength</td> <td>9</td> <td></td> </tr> <tr> <td>pattern</td> <td>(\p{L}\p{N}\p{N}.*)?</td> <td></td> </tr> </tbody> </table>	Kind	Value	Annotation	minLength	3		maxLength	9		pattern	(\p{L}\p{N}\p{N}.*)?	
Kind	Value	Annotation											
minLength	3												
maxLength	9												
pattern	(\p{L}\p{N}\p{N}.*)?												
annotation	documentation GDI02: ICD-Schlüssel												
source	<pre><xs:attribute name="icd" use="optional"> <xs:annotation> <xs:documentation>GDI02: ICD-Schlüssel</xs:documentation> </xs:annotation> <xs:simpleType> <xs:restriction base="md:ICD_Schluesel_Stp"/> </xs:simpleType> </xs:attribute></pre>												

attribute Begutachtung/Stellungnahme/Pruefung/Diagnosen/Diagnose/KH/@lokalisierung

type	Lokalisation_Stp												
properties	use optional												
facets	<table border="1"> <thead> <tr> <th>Kind</th> <th>Value</th> <th>Annotation</th> </tr> </thead> <tbody> <tr> <td>enumeration</td> <td>B</td> <td></td> </tr> <tr> <td>enumeration</td> <td>L</td> <td></td> </tr> <tr> <td>enumeration</td> <td>R</td> <td></td> </tr> </tbody> </table>	Kind	Value	Annotation	enumeration	B		enumeration	L		enumeration	R	
Kind	Value	Annotation											
enumeration	B												
enumeration	L												
enumeration	R												
annotation	documentation GDI03: Lokalisation												
source	<pre><xs:attribute name="Lokalisation" type="md:Lokalisation_Stp" use="optional"> <xs:annotation> <xs:documentation>GDI03: Lokalisation</xs:documentation> </xs:annotation> </xs:attribute></pre>												

element Begutachtung/Stellungnahme/Pruefung/Diagnosen/Diagnose/MD

diagram																															
namespace	http://www.aok-systems.de/xml-schema/mdk-kh-standard_V07.00																														
properties	content complex																														
attributes	<table border="1"> <thead> <tr> <th>Name</th> <th>Type</th> <th>Use</th> <th>Default</th> <th>Fixed</th> <th>Annotation</th> </tr> </thead> <tbody> <tr> <td>icd</td> <td>derived by: ICD_Schluessel_Stp</td> <td>optional</td> <td></td> <td></td> <td>documentation GDI04: ICD-Schlüssel</td> </tr> <tr> <td>lokalisati on</td> <td>Lokalisati on_Stp</td> <td>optional</td> <td></td> <td></td> <td>documentation GDI05: Lokalisati on</td> </tr> <tr> <td>antwort</td> <td>Antwortzei chen</td> <td>required</td> <td></td> <td></td> <td>documentation GDI06: Antwort MD</td> </tr> <tr> <td>erlaeuterung</td> <td>Freitext_1024</td> <td>optional</td> <td></td> <td></td> <td>documentation GDI07: Erläuterungen MD</td> </tr> </tbody> </table>	Name	Type	Use	Default	Fixed	Annotation	icd	derived by: ICD_Schluessel_Stp	optional			documentation GDI04: ICD-Schlüssel	lokalisati on	Lokalisati on_Stp	optional			documentation GDI05: Lokalisati on	antwort	Antwortzei chen	required			documentation GDI06: Antwort MD	erlaeuterung	Freitext_1024	optional			documentation GDI07: Erläuterungen MD
Name	Type	Use	Default	Fixed	Annotation																										
icd	derived by: ICD_Schluessel_Stp	optional			documentation GDI04: ICD-Schlüssel																										
lokalisati on	Lokalisati on_Stp	optional			documentation GDI05: Lokalisati on																										
antwort	Antwortzei chen	required			documentation GDI06: Antwort MD																										
erlaeuterung	Freitext_1024	optional			documentation GDI07: Erläuterungen MD																										
annotation	documentation GDI04-GDI07																														
source	<pre> <xs:element name="MD"> <xs:annotation> <xs:documentation>GDI 04-GDI 07</xs:documentation> </xs:annotation> <xs:complexType> <xs:attribute name="icd" use="optional"> <xs:annotation> <xs:documentation>GDI 04: ICD-Schlüssel</xs:documentation> </xs:annotation> <xs:simpleType> <xs:restriction base="md:ICD_Schluessel_Stp"/> </xs:simpleType> </xs:attribute> <xs:attribute name="lokalisati on" type="md:Lokalisati on_Stp" use="optional"> <xs:annotation> <xs:documentation>GDI 05: Lokalisati on</xs:documentation> </xs:annotation> </xs:attribute> <xs:attribute name="antwort" type="kh:Antwortzei chen" use="required"> <xs:annotation> <xs:documentation>GDI 06: Antwort MD</xs:documentation> </xs:annotation> </xs:attribute> </xs:complexType> </xs:element> </pre>																														

	<pre> </xs: annotation> </xs: attribute> <xs: attribute name="erläuterung" type="kh: Frei text_1024" use="optional "> <xs: annotation> <xs: documentation>GDI 07: Erläuterungen MD</xs: documentation> </xs: annotation> </xs: attribute> </xs: complexType> </xs: element> </pre>
--	--

attribute Begutachtung/Stellungnahme/Pruefung/Diagnosen/Diagnose/MD/@icd

type	restriction of ICD_Schlüssel_Stp												
properties	use optional												
facets	<table border="1"> <thead> <tr> <th>Kind</th> <th>Value</th> <th>Annotation</th> </tr> </thead> <tbody> <tr> <td>minLength</td> <td>3</td> <td></td> </tr> <tr> <td>maxLength</td> <td>9</td> <td></td> </tr> <tr> <td>pattern</td> <td>(\p{L}\p{N}\p{N}.*)?</td> <td></td> </tr> </tbody> </table>	Kind	Value	Annotation	minLength	3		maxLength	9		pattern	(\p{L}\p{N}\p{N}.*)?	
Kind	Value	Annotation											
minLength	3												
maxLength	9												
pattern	(\p{L}\p{N}\p{N}.*)?												
annotation	documentation GDI04: ICD-Schlüssel												
source	<pre> <xs: attribute name="icd" use="optional "> <xs: annotation> <xs: documentation>GDI 04: ICD-Schlüssel</xs: documentation> </xs: annotation> <xs: simpleType> <xs: restriction base="md: ICD_Schlüssel_Stp" /> </xs: simpleType> </xs: attribute> </pre>												

attribute Begutachtung/Stellungnahme/Pruefung/Diagnosen/Diagnose/MD/@lokalisierung

type	Lokalisation_Stp												
properties	use optional												
facets	<table border="1"> <thead> <tr> <th>Kind</th> <th>Value</th> <th>Annotation</th> </tr> </thead> <tbody> <tr> <td>enumeration</td> <td>B</td> <td></td> </tr> <tr> <td>enumeration</td> <td>L</td> <td></td> </tr> <tr> <td>enumeration</td> <td>R</td> <td></td> </tr> </tbody> </table>	Kind	Value	Annotation	enumeration	B		enumeration	L		enumeration	R	
Kind	Value	Annotation											
enumeration	B												
enumeration	L												
enumeration	R												
annotation	documentation GDI05: Lokalisation												
source	<pre> <xs: attribute name="Lokalisation" type="md: Lokalisation_Stp" use="optional "> <xs: annotation> <xs: documentation>GDI 05: Lokalisation</xs: documentation> </xs: annotation> </xs: attribute> </pre>												

attribute Begutachtung/Stellungnahme/Pruefung/Diagnosen/Diagnose/MD/@antwort

type	Antwortzeichen
------	--------------------------------

properties	use required															
facets	<table border="1"> <thead> <tr> <th>Kind</th> <th>Value</th> <th>Annotation</th> </tr> </thead> <tbody> <tr> <td>enumeration</td> <td>0</td> <td></td> </tr> <tr> <td>enumeration</td> <td>1</td> <td></td> </tr> <tr> <td>enumeration</td> <td>2</td> <td></td> </tr> <tr> <td>enumeration</td> <td>9</td> <td></td> </tr> </tbody> </table>	Kind	Value	Annotation	enumeration	0		enumeration	1		enumeration	2		enumeration	9	
Kind	Value	Annotation														
enumeration	0															
enumeration	1															
enumeration	2															
enumeration	9															
annotation	documentation GDI06: Antwort MD															
source	<pre><xs:attribute name="antwort" type="kh:Antwortzeichen" use="required"> <xs:annotation> <xs:documentation>GDI06: Antwort MD</xs:documentation> </xs:annotation> </xs:attribute></pre>															

attribute Begutachtung/Stellungnahme/Pruefung/Diagnosen/Diagnose/MD/@erlaeuterung

type	Freitext_1024									
properties	use optional									
facets	<table border="1"> <thead> <tr> <th>Kind</th> <th>Value</th> <th>Annotation</th> </tr> </thead> <tbody> <tr> <td>minLength</td> <td>1</td> <td></td> </tr> <tr> <td>maxLength</td> <td>1024</td> <td></td> </tr> </tbody> </table>	Kind	Value	Annotation	minLength	1		maxLength	1024	
Kind	Value	Annotation								
minLength	1									
maxLength	1024									
annotation	documentation GDI07: Erläuterungen MD									
source	<pre><xs:attribute name="erlaeuterung" type="kh:Freitext_1024" use="optional"> <xs:annotation> <xs:documentation>GDI07: Erläuterungen MD</xs:documentation> </xs:annotation> </xs:attribute></pre>									

element Begutachtung/Stellungnahme/Pruefung/Prozeduren

diagram															
namespace	http://www.aok-systems.de/xml-schema/mdk-kh-standard_V07.00														
properties	minOcc 0 maxOcc 1 content complex														
children	Prozedur														
attributes	<table border="1"> <thead> <tr> <th>Name</th> <th>Type</th> <th>derived by:</th> <th>Use</th> <th>Default</th> <th>Fixed</th> <th>Annotation</th> </tr> </thead> <tbody> <tr> <td>ops_version</td> <td>xs:gYear</td> <td>derived by:</td> <td>required</td> <td></td> <td></td> <td>documentation GFK06:</td> </tr> </tbody> </table>	Name	Type	derived by:	Use	Default	Fixed	Annotation	ops_version	xs:gYear	derived by:	required			documentation GFK06:
Name	Type	derived by:	Use	Default	Fixed	Annotation									
ops_version	xs:gYear	derived by:	required			documentation GFK06:									

annotation	documentation GOP-Satz und GFK06
source	<pre> <xs:element name="Prozeduren" minOccurs="0"> <xs:annotation> <xs:documentation>GOP-Satz und GFK06</xs:documentation> </xs:annotation> <xs:complexType> <xs:sequence> <xs:element name="Prozedur" maxOccurs="999"> <xs:annotation> <xs:documentation>GOP-Sätze</xs:documentation> </xs:annotation> <xs:complexType> <xs:sequence> <xs:element name="KH"> <xs:annotation> <xs:documentation>GOP01-03</xs:documentation> </xs:annotation> <xs:complexType> <xs:attribute name="ops" use="optional"> <xs:annotation> <xs:documentation>GOP01: OPS-Schlüssel</xs:documentation> </xs:annotation> <xs:simpleType> <xs:restriction base="kh:OPS_Schlüssel"/> </xs:simpleType> </xs:attribute> <xs:attribute name="lokalisation" type="md:Lokalisation_Stp" use="optional"> <xs:annotation> <xs:documentation>GOP02: Lokalisation</xs:documentation> </xs:annotation> </xs:attribute> <xs:attribute name="datum_ops" type="md:Datum_Stp" use="optional"> <xs:annotation> <xs:documentation>GOP03: Datum OPS im Format (JJJJ-MM-TT)</xs:documentation> </xs:annotation> </xs:attribute> </xs:complexType> </xs:element> <xs:element name="MD"> <xs:annotation> <xs:documentation>GOP04-08</xs:documentation> </xs:annotation> <xs:complexType> <xs:attribute name="ops" type="kh:OPS_Schlüssel" use="optional"> <xs:annotation> <xs:documentation>GOP04: OPS-Schlüssel MD</xs:documentation> </xs:annotation> </xs:attribute> <xs:attribute name="lokalisation" type="md:Lokalisation_Stp" use="optional"> </pre>

```

        <xs: annotation>
          <xs: documentati on>GOP05: Lokal i sati on MD</xs: documentati on>
        </xs: annotation>
      </xs: attribute>
      <xs: attribute name="datum_ops" type="md: Datum_Stp"
use="opti onal ">
        <xs: annotation>
          <xs: documentati on>GOP06: Datum OPS MD im Format
(JJJJ-MM-TT)</xs: documentati on>
        </xs: annotation>
      </xs: attribute>
      <xs: attribute name="antwort" type="kh: Antwortzei chen"
use="requi red">
        <xs: annotation>
          <xs: documentati on>GOP07: Antwort MD</xs: documentati on>
        </xs: annotation>
      </xs: attribute>
      <xs: attribute name="erl aeuterung" type="kh: Frei text_1024"
use="opti onal ">
        <xs: annotation>
          <xs: documentati on>GOP08: Erl aeuterungen MD</xs: documentati on>
        </xs: annotation>
      </xs: attribute>
    </xs: compl exType>
  </xs: el ement>
</xs: sequence>
</xs: compl exType>
</xs: el ement>
</xs: sequence>
<xs: attribute name="ops_versi on" use="requi red">
  <xs: annotation>
    <xs: documentati on>GFK06: OPS-Versi on</xs: documentati on>
  </xs: annotation>
  <xs: si mpl eType>
    <xs: restri cti on base="xs: gYear">
      <xs: mi nI ncl usi ve val ue="2003" />
      <xs: ma xI ncl usi ve val ue="2099" />
    </xs: restri cti on>
  </xs: si mpl eType>
</xs: attribute>
</xs: compl exType>
</xs: el ement>

```

attribute Begutachtung/Stellungnahme/Pruefung/Prozeduren/@ops_version

type	restriction of xs:gYear									
properties	use required									
facets	<table border="1"> <thead> <tr> <th>Kind</th> <th>Value</th> <th>Annotation</th> </tr> </thead> <tbody> <tr> <td>minInclusive</td> <td>2003</td> <td></td> </tr> <tr> <td>maxInclusive</td> <td>2099</td> <td></td> </tr> </tbody> </table>	Kind	Value	Annotation	minInclusive	2003		maxInclusive	2099	
Kind	Value	Annotation								
minInclusive	2003									
maxInclusive	2099									
annotation	documentation GFK06: OPS-Version									

source	<pre> <xs:attribute name="ops_version" use="required"> <xs:annotation> <xs:documentation>GFK06: OPS-Version</xs:documentation> </xs:annotation> <xs:simpleType> <xs:restriction base="xs:gYear"> <xs:minInclusive value="2003"/> <xs:maxInclusive value="2099"/> </xs:restriction> </xs:simpleType> </xs:attribute> </pre>
--------	--

element Begutachtung/Stellungnahme/Pruefung/Prozeduren/Prozedur

diagram	
namespace	http://www.aok-systems.de/xml-schema/mdk-kh-standard_V07.00
properties	minOcc 1 maxOcc 999 content complex
children	KH MD
annotation	documentation GOP-Sätze
source	<pre> <xs:element name="Prozedur" maxOccurs="999"> <xs:annotation> <xs:documentation>GOP-Sätze</xs:documentation> </xs:annotation> <xs:complexType> <xs:sequence> <xs:element name="KH"> <xs:annotation> <xs:documentation>GOP01-03</xs:documentation> </xs:annotation> <xs:complexType> <xs:attribute name="ops" use="optional"> <xs:annotation> <xs:documentation>GOP01: OPS-Schlüssel</xs:documentation> </xs:annotation> <xs:simpleType> <xs:restriction base="kh:OPS_Schluessel"/> </xs:simpleType> </xs:attribute> <xs:attribute name="Lokalisierung" type="md:Lokalisierung_Stp" use="optional"> <xs:annotation> <xs:documentation>GOP02: Lokalisierung</xs:documentation> </xs:annotation> </pre>

```

        </xs:attribute>
        <xs:attribute name="datum_ops" type="md: Datum_Stp" use="optional">
          <xs:annotation>
            <xs:documentation>GOP03: Datum OPS im Format
(JJJJ-MM-TT)</xs:documentation>
          </xs:annotation>
        </xs:attribute>
      </xs:complexType>
    </xs:element>
    <xs:element name="MD">
      <xs:annotation>
        <xs:documentation>GOP04-08</xs:documentation>
      </xs:annotation>
      <xs:complexType>
        <xs:attribute name="ops" type="kh: OPS_Schl_uessel " use="optional">
          <xs:annotation>
            <xs:documentation>GOP04: OPS-Schlüssel MD</xs:documentation>
          </xs:annotation>
        </xs:attribute>
        <xs:attribute name="lokalisierung" type="md: Lokalisierung_Stp"
use="optional">
          <xs:annotation>
            <xs:documentation>GOP05: Lokalisierung MD</xs:documentation>
          </xs:annotation>
        </xs:attribute>
        <xs:attribute name="datum_ops" type="md: Datum_Stp" use="optional">
          <xs:annotation>
            <xs:documentation>GOP06: Datum OPS MD im Format
(JJJJ-MM-TT)</xs:documentation>
          </xs:annotation>
        </xs:attribute>
        <xs:attribute name="antwort" type="kh: Antwortzeichen" use="required">
          <xs:annotation>
            <xs:documentation>GOP07: Antwort MD</xs:documentation>
          </xs:annotation>
        </xs:attribute>
        <xs:attribute name="erlaeuterung" type="kh: Freitext_1024"
use="optional">
          <xs:annotation>
            <xs:documentation>GOP08: Erläuterungen MD</xs:documentation>
          </xs:annotation>
        </xs:attribute>
      </xs:complexType>
    </xs:element>
  </xs:sequence>
</xs:complexType>
</xs:element>

```

element Begutachtung/Stellungnahme/Pruefung/Prozeduren/Prozedur/KH

diagram																									
namespace	http://www.aok-systems.de/xml-schema/mdk-kh-standard_V07.00																								
properties	content complex																								
attributes	<table border="1"> <thead> <tr> <th>Name</th> <th>Type</th> <th>Use</th> <th>Default</th> <th>Fixed</th> <th>Annotation</th> </tr> </thead> <tbody> <tr> <td>ops</td> <td>derived by: OPS_Schluessel</td> <td>optional</td> <td></td> <td></td> <td>documentation GOP01: OPS-Schlüssel</td> </tr> <tr> <td>lokalisierung</td> <td>Lokalisation_Stp</td> <td>optional</td> <td></td> <td></td> <td>documentation GOP02: Lokalisation</td> </tr> <tr> <td>datum_ops</td> <td>Datum_Stp</td> <td>optional</td> <td></td> <td></td> <td>documentation GOP03: Datum OPS im Format (JJJJ-MM-TT)</td> </tr> </tbody> </table>	Name	Type	Use	Default	Fixed	Annotation	ops	derived by: OPS_Schluessel	optional			documentation GOP01: OPS-Schlüssel	lokalisierung	Lokalisation_Stp	optional			documentation GOP02: Lokalisation	datum_ops	Datum_Stp	optional			documentation GOP03: Datum OPS im Format (JJJJ-MM-TT)
Name	Type	Use	Default	Fixed	Annotation																				
ops	derived by: OPS_Schluessel	optional			documentation GOP01: OPS-Schlüssel																				
lokalisierung	Lokalisation_Stp	optional			documentation GOP02: Lokalisation																				
datum_ops	Datum_Stp	optional			documentation GOP03: Datum OPS im Format (JJJJ-MM-TT)																				
annotation	documentation GOP01-03																								
source	<pre> <xs:element name="KH"> <xs:annotation> <xs:documentation>GOP01-03</xs:documentation> </xs:annotation> <xs:complexType> <xs:attribute name="ops" use="optional"> <xs:annotation> <xs:documentation>GOP01: OPS-Schlüssel</xs:documentation> </xs:annotation> <xs:simpleType> <xs:restriction base="kh:OPS_Schluessel"/> </xs:simpleType> </xs:attribute> <xs:attribute name="lokalisierung" type="md:Lokalisation_Stp" use="optional"> <xs:annotation> <xs:documentation>GOP02: Lokalisation</xs:documentation> </xs:annotation> </xs:attribute> <xs:attribute name="datum_ops" type="md:Datum_Stp" use="optional"> <xs:annotation> <xs:documentation>GOP03: Datum OPS im Format (JJJJ-MM-TT)</xs:documentation> </xs:annotation> </xs:attribute> </xs:complexType> </pre>																								

	<code></xs:element></code>
--	----------------------------------

attribute Begutachtung/Stellungnahme/Pruefung/Prozeduren/Prozedur/KH/@ops

type	restriction of OPS_Schluessel						
properties	use optional						
facets	<table border="1"> <thead> <tr> <th>Kind</th> <th>Value</th> <th>Annotation</th> </tr> </thead> <tbody> <tr> <td>maxLength</td> <td>11</td> <td></td> </tr> </tbody> </table>	Kind	Value	Annotation	maxLength	11	
Kind	Value	Annotation					
maxLength	11						
annotation	documentation GOP01: OPS-Schlüssel						
source	<pre><xs:attribute name="ops" use="optional"> <xs:annotation> <xs:documentation>GOP01: OPS-Schlüssel </xs:documentation> </xs:annotation> <xs:simpleType> <xs:restriction base="kh:OPS_Schluessel"/> </xs:simpleType> </xs:attribute></pre>						

attribute Begutachtung/Stellungnahme/Pruefung/Prozeduren/Prozedur/KH/@lokalisierung

type	Lokalisation_Stp												
properties	use optional												
facets	<table border="1"> <thead> <tr> <th>Kind</th> <th>Value</th> <th>Annotation</th> </tr> </thead> <tbody> <tr> <td>enumeration</td> <td>B</td> <td></td> </tr> <tr> <td>enumeration</td> <td>L</td> <td></td> </tr> <tr> <td>enumeration</td> <td>R</td> <td></td> </tr> </tbody> </table>	Kind	Value	Annotation	enumeration	B		enumeration	L		enumeration	R	
Kind	Value	Annotation											
enumeration	B												
enumeration	L												
enumeration	R												
annotation	documentation GOP02: Lokalisation												
source	<pre><xs:attribute name="Lokalisation" type="md:Lokalisation_Stp" use="optional"> <xs:annotation> <xs:documentation>GOP02: Lokalisation</xs:documentation> </xs:annotation> </xs:attribute></pre>												

attribute Begutachtung/Stellungnahme/Pruefung/Prozeduren/Prozedur/KH/@datum_ops

type	Datum_Stp									
properties	use optional									
facets	<table border="1"> <thead> <tr> <th>Kind</th> <th>Value</th> <th>Annotation</th> </tr> </thead> <tbody> <tr> <td>minInclusive</td> <td>1850-01-01</td> <td></td> </tr> <tr> <td>maxInclusive</td> <td>2099-12-31</td> <td></td> </tr> </tbody> </table>	Kind	Value	Annotation	minInclusive	1850-01-01		maxInclusive	2099-12-31	
Kind	Value	Annotation								
minInclusive	1850-01-01									
maxInclusive	2099-12-31									
annotation	documentation GOP03: Datum OPS im Format (JJJJ-MM-TT)									
source	<pre><xs:attribute name="datum_ops" type="md:Datum_Stp" use="optional"> <xs:annotation> <xs:documentation>GOP03: Datum OPS im Format (JJJJ-MM-TT)</xs:documentation> </xs:annotation> </xs:attribute></pre>									

```
</xs: annotation>
</xs: attribute>
```

element Begutachtung/Stellungnahme/Pruefung/Prozeduren/Prozedur/MD

diagram																																					
namespace	http://www.aok-systems.de/xml-schema/mdk-kh-standard_V07.00																																				
properties	content complex																																				
attributes	<table border="1"> <thead> <tr> <th>Name</th> <th>Type</th> <th>Use</th> <th>Default</th> <th>Fixed</th> <th>Annotation</th> </tr> </thead> <tbody> <tr> <td>ops</td> <td>OPS_Schluesssel</td> <td>optional</td> <td></td> <td></td> <td>documentation GOP04: OPS-Schlüssel MD</td> </tr> <tr> <td>lokalisierung</td> <td>Lokalisation_Stp</td> <td>optional</td> <td></td> <td></td> <td>documentation GOP05: Lokalisation MD</td> </tr> <tr> <td>datum_ops</td> <td>Datum_Stp</td> <td>optional</td> <td></td> <td></td> <td>documentation GOP06: Datum OPS MD im Format (JJJ-MM-TT)</td> </tr> <tr> <td>antwort</td> <td>Antwortzeichen</td> <td>required</td> <td></td> <td></td> <td>documentation GOP07: Antwort MD</td> </tr> <tr> <td>erlaeuterung</td> <td>Freitext_1024</td> <td>optional</td> <td></td> <td></td> <td>documentation GOP08: Erläuterungen MD</td> </tr> </tbody> </table>	Name	Type	Use	Default	Fixed	Annotation	ops	OPS_Schluesssel	optional			documentation GOP04: OPS-Schlüssel MD	lokalisierung	Lokalisation_Stp	optional			documentation GOP05: Lokalisation MD	datum_ops	Datum_Stp	optional			documentation GOP06: Datum OPS MD im Format (JJJ-MM-TT)	antwort	Antwortzeichen	required			documentation GOP07: Antwort MD	erlaeuterung	Freitext_1024	optional			documentation GOP08: Erläuterungen MD
Name	Type	Use	Default	Fixed	Annotation																																
ops	OPS_Schluesssel	optional			documentation GOP04: OPS-Schlüssel MD																																
lokalisierung	Lokalisation_Stp	optional			documentation GOP05: Lokalisation MD																																
datum_ops	Datum_Stp	optional			documentation GOP06: Datum OPS MD im Format (JJJ-MM-TT)																																
antwort	Antwortzeichen	required			documentation GOP07: Antwort MD																																
erlaeuterung	Freitext_1024	optional			documentation GOP08: Erläuterungen MD																																
annotation	documentation GOP04-08																																				
source	<pre><xs: element name="MD"> <xs: annotation> <xs: documentati on>GOP04-08</xs: documentati on> </xs: annotation> <xs: compl exType> <xs: attri bute name="ops" type="kh: OPS_Schl uessel " use="opti onal "></pre>																																				

	<pre> <xs: annotation> <xs: documentation>GOP04: OPS-Schlüssel MD</xs: documentation> </xs: annotation> </xs: attribute> <xs: attribute name="Lokalisation" type="md:Lokalisation_Stp" use="optional"> <xs: annotation> <xs: documentation>GOP05: Lokalisation MD</xs: documentation> </xs: annotation> </xs: attribute> <xs: attribute name="datum_ops" type="md:Datum_Stp" use="optional"> <xs: annotation> <xs: documentation>GOP06: Datum OPS MD im Format (JJJJ-MM-TT)</xs: documentation> </xs: annotation> </xs: attribute> <xs: attribute name="antwort" type="kh:Antwortzeichen" use="required"> <xs: annotation> <xs: documentation>GOP07: Antwort MD</xs: documentation> </xs: annotation> </xs: attribute> <xs: attribute name="erlaeuterung" type="kh:Freitext_1024" use="optional"> <xs: annotation> <xs: documentation>GOP08: Erläuterungen MD</xs: documentation> </xs: annotation> </xs: attribute> </xs: complexType> </xs: element> </pre>
--	---

attribute Begutachtung/Stellungnahme/Pruefung/Prozeduren/Prozedur/MD/@ops

type	OPS_Schlüssel						
properties	use optional						
facets	<table border="1"> <thead> <tr> <th>Kind</th> <th>Value</th> <th>Annotation</th> </tr> </thead> <tbody> <tr> <td>maxLength</td> <td>11</td> <td></td> </tr> </tbody> </table>	Kind	Value	Annotation	maxLength	11	
Kind	Value	Annotation					
maxLength	11						
annotation	documentation GOP04: OPS-Schlüssel MD						
source	<pre> <xs: attribute name="ops" type="kh:OPS_Schl uessel " use="opti onal "> <xs: annotation> <xs: documentati on>GOP04: OPS-Schl üssel MD</xs: documentati on> </xs: annotation> </xs: attribute> </pre>						

attribute Begutachtung/Stellungnahme/Pruefung/Prozeduren/Prozedur/MD/@lokalisierung

type	Lokalisation_Stp												
properties	use optional												
facets	<table border="1"> <thead> <tr> <th>Kind</th> <th>Value</th> <th>Annotation</th> </tr> </thead> <tbody> <tr> <td>enumeration</td> <td>B</td> <td></td> </tr> <tr> <td>enumeration</td> <td>L</td> <td></td> </tr> <tr> <td>enumeration</td> <td>R</td> <td></td> </tr> </tbody> </table>	Kind	Value	Annotation	enumeration	B		enumeration	L		enumeration	R	
Kind	Value	Annotation											
enumeration	B												
enumeration	L												
enumeration	R												

annotation	documentation GOP05: Lokalisation MD
source	<xs:attribute name="Lokalisation" type="md:Lokalisation_Stp" use="optional"> <xs:annotation> <xs:documentation>GOP05: Lokalisation MD</xs:documentation> </xs:annotation> </xs:attribute>

attribute Begutachtung/Stellungnahme/Pruefung/Prozeduren/Prozedur/MD/@datum_ops

type	Datum_Stp									
properties	use optional									
facets	<table border="1"> <thead> <tr> <th>Kind</th> <th>Value</th> <th>Annotation</th> </tr> </thead> <tbody> <tr> <td>minInclusive</td> <td>1850-01-01</td> <td></td> </tr> <tr> <td>maxInclusive</td> <td>2099-12-31</td> <td></td> </tr> </tbody> </table>	Kind	Value	Annotation	minInclusive	1850-01-01		maxInclusive	2099-12-31	
Kind	Value	Annotation								
minInclusive	1850-01-01									
maxInclusive	2099-12-31									
annotation	documentation GOP06: Datum OPS MD im Format (JJJ-MM-TT)									
source	<xs:attribute name="datum_ops" type="md:Datum_Stp" use="optional"> <xs:annotation> <xs:documentation>GOP06: Datum OPS MD im Format (JJJJ-MM-TT)</xs:documentation> </xs:annotation> </xs:attribute>									

attribute Begutachtung/Stellungnahme/Pruefung/Prozeduren/Prozedur/MD/@antwort

type	Antwortzeichen															
properties	use required															
facets	<table border="1"> <thead> <tr> <th>Kind</th> <th>Value</th> <th>Annotation</th> </tr> </thead> <tbody> <tr> <td>enumeration</td> <td>0</td> <td></td> </tr> <tr> <td>enumeration</td> <td>1</td> <td></td> </tr> <tr> <td>enumeration</td> <td>2</td> <td></td> </tr> <tr> <td>enumeration</td> <td>9</td> <td></td> </tr> </tbody> </table>	Kind	Value	Annotation	enumeration	0		enumeration	1		enumeration	2		enumeration	9	
Kind	Value	Annotation														
enumeration	0															
enumeration	1															
enumeration	2															
enumeration	9															
annotation	documentation GOP07: Antwort MD															
source	<xs:attribute name="antwort" type="kh:Antwortzeichen" use="required"> <xs:annotation> <xs:documentation>GOP07: Antwort MD</xs:documentation> </xs:annotation> </xs:attribute>															

attribute Begutachtung/Stellungnahme/Pruefung/Prozeduren/Prozedur/MD/@erlaeuterung

type	Freitext 1024						
properties	use optional						
facets	<table border="1"> <thead> <tr> <th>Kind</th> <th>Value</th> <th>Annotation</th> </tr> </thead> <tbody> <tr> <td>minLength</td> <td>1</td> <td></td> </tr> </tbody> </table>	Kind	Value	Annotation	minLength	1	
Kind	Value	Annotation					
minLength	1						

	maxLength 1024
annotation	documentation GOP08: Erläuterungen MD
source	<xs:attribute name="erläuterung" type="kh:Frei text_1024" use="optional"> <xs:annotation> <xs:documentation>GOP08: Erläuterungen MD</xs:documentation> </xs:annotation> </xs:attribute>

element Begutachtung/Stellungnahme/Pruefung/Entlassung

diagram	
namespace	http://www.aok-systems.de/xml-schema/mdk-kh-standard_V07.00
properties	minOcc 0 maxOcc 1 content complex
children	Abteilungstyp Entlassungsgrund MD_DRG MD_PEPP Bewertungsrelation Beatmungsstunden Entbindung TOB
annotation	documentation GEK-Satz
source	<xs:element name="Entlassung" minOccurs="0">

```

<xs: annotation>
  <xs: documentation>GEK-Satz</xs: documentation>
</xs: annotation>
<xs: complexType>
  <xs: sequence>
    <xs: element name="Abteilungstyp" type="md: Abteilungstyp_Stp" minOccurs="0">
      <xs: annotation>
        <xs: documentation>GEK01: Zusatzschlüssel Abteilungstyp
MD</xs: documentation>
      </xs: annotation>
    </xs: element>
    <xs: element name="Entlassungsgrund" type="kh: Entlassungsgrund">
      <xs: annotation>
        <xs: documentation>GEK02: Grund der Entlassung/ Verlegung
MD</xs: documentation>
      </xs: annotation>
    </xs: element>
    <xs: choice>
      <xs: sequence>
        <xs: element name="MD_DRG" minOccurs="0">
          <xs: annotation>
            <xs: documentation>GEK03-04</xs: documentation>
          </xs: annotation>
          <xs: complexType>
            <xs: attribute name="DRG" use="optional">
              <xs: annotation>
                <xs: documentation>GEK03: DRG-MD</xs: documentation>
              </xs: annotation>
            </xs: attribute>
            <xs: restriction base="kh: DRG"/>
          </xs: complexType>
          <xs: attribute name="relativgewicht" use="optional">
            <xs: annotation>
              <xs: documentation>GEK04: Eff. Relativgewicht der
DRG-MD</xs: documentation>
            </xs: annotation>
            <xs: simpleType>
              <xs: restriction base="xs: decimal">
                <xs: totalDigits value="8"/>
                <xs: fractionDigits value="3"/>
                <xs: maxExclusive value="100000"/>
              </xs: restriction>
            </xs: simpleType>
          </xs: attribute>
        </xs: sequence>
      </xs: choice>
    </xs: sequence>
  </xs: complexType>
  <xs: sequence>
    <xs: element name="MD_PEPP" minOccurs="0">
      <xs: annotation>
        <xs: documentation>GEK09: PEPP MD</xs: documentation>
      </xs: annotation>
    </xs: element>
    <xs: restriction base="xs: string">

```

```

        <xs:maxLength value="5"/>
        <xs:minLength value="1"/>
      </xs:restriction>
    </xs:simpleType>
  </xs:element>
  <xs:element name="Bewertungsrelation" minOccurs="0">
    <xs:annotation>
      <xs:documentation>GEK10: Eff. Bewertungsrelation der PEPP
MD</xs:documentation>
    </xs:annotation>
    <xs:simpleType>
      <xs:restriction base="xs:decimal">
        <xs:totalDigits value="8"/>
        <xs:fractionDigits value="4"/>
        <xs:maxExclusive value="10000"/>
      </xs:restriction>
    </xs:simpleType>
  </xs:element>
</xs:sequence>
</xs:choice>
<xs:element name="Beatmungsstunden" minOccurs="0">
  <xs:annotation>
    <xs:documentation>GEK05: Anzahl Beatmungsstunden</xs:documentation>
  </xs:annotation>
  <xs:simpleType>
    <xs:restriction base="xs:int">
      <xs:minInclusive value="0"/>
      <xs:maxInclusive value="9999"/>
    </xs:restriction>
  </xs:simpleType>
</xs:element>
<xs:element name="Entbindung" minOccurs="0" maxOccurs="2">
  <xs:annotation>
    <xs:documentation>GEK06-07: Tag der Entbindung MD im Format
(JJJJ-MM-TT)</xs:documentation>
  </xs:annotation>
  <xs:simpleType>
    <xs:restriction base="md:Datum_Stp"/>
  </xs:simpleType>
</xs:element>
<xs:element name="TOB" type="kh:Anzahl_Tage3" minOccurs="0">
  <xs:annotation>
    <xs:documentation>GEK08: Tage ohne Berechnung (TOB)</xs:documentation>
  </xs:annotation>
</xs:element>
</xs:sequence>
</xs:complexType>
</xs:element>

```

element Begutachtung/Stellungnahme/Pruefung/Entlassung/Abteilungstyp

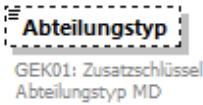
diagram																																																				
namespace	http://www.aok-systems.de/xml-schema/mdk-kh-standard_V07.00																																																			
type	Abteilungstyp_Stp																																																			
properties	minOcc 0 maxOcc 1 content simple																																																			
facets	<table border="1"> <thead> <tr> <th>Kind</th> <th>Value</th> <th>Annotation</th> </tr> </thead> <tbody> <tr><td>enumeration</td><td>1</td><td></td></tr> <tr><td>enumeration</td><td>2</td><td></td></tr> <tr><td>enumeration</td><td>3</td><td></td></tr> <tr><td>enumeration</td><td>4</td><td></td></tr> <tr><td>enumeration</td><td>5</td><td></td></tr> <tr><td>enumeration</td><td>6</td><td></td></tr> <tr><td>enumeration</td><td>7</td><td></td></tr> <tr><td>enumeration</td><td>8</td><td></td></tr> <tr><td>enumeration</td><td>A</td><td></td></tr> <tr><td>enumeration</td><td>B</td><td></td></tr> <tr><td>enumeration</td><td>C</td><td></td></tr> <tr><td>enumeration</td><td>D</td><td></td></tr> <tr><td>enumeration</td><td>E</td><td></td></tr> <tr><td>enumeration</td><td>F</td><td></td></tr> <tr><td>enumeration</td><td>G</td><td></td></tr> <tr><td>enumeration</td><td>H</td><td></td></tr> </tbody> </table>	Kind	Value	Annotation	enumeration	1		enumeration	2		enumeration	3		enumeration	4		enumeration	5		enumeration	6		enumeration	7		enumeration	8		enumeration	A		enumeration	B		enumeration	C		enumeration	D		enumeration	E		enumeration	F		enumeration	G		enumeration	H	
Kind	Value	Annotation																																																		
enumeration	1																																																			
enumeration	2																																																			
enumeration	3																																																			
enumeration	4																																																			
enumeration	5																																																			
enumeration	6																																																			
enumeration	7																																																			
enumeration	8																																																			
enumeration	A																																																			
enumeration	B																																																			
enumeration	C																																																			
enumeration	D																																																			
enumeration	E																																																			
enumeration	F																																																			
enumeration	G																																																			
enumeration	H																																																			
annotation	documentation GEK01: Zusatzschlüssel Abteilungstyp MD																																																			
source	<pre><xs:element name="Abteilungstyp" type="md:Abteilungstyp_Stp" minOccurs="0"> <xs:annotation> <xs:documentation>GEK01: Zusatzschlüssel Abteilungstyp MD</xs:documentation> </xs:annotation> </xs:element></pre>																																																			

element Begutachtung/Stellungnahme/Pruefung/Entlassung/Entlassungsgrund

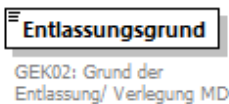
diagram							
namespace	http://www.aok-systems.de/xml-schema/mdk-kh-standard_V07.00						
type	Entlassungsgrund						
properties	content simple						
facets	<table border="1"> <thead> <tr> <th>Kind</th> <th>Value</th> <th>Annotation</th> </tr> </thead> <tbody> <tr><td>length</td><td>3</td><td></td></tr> </tbody> </table>	Kind	Value	Annotation	length	3	
Kind	Value	Annotation					
length	3						

	pattern [0-9]{3}
annotation	documentation GEK02: Grund der Entlassung/ Verlegung MD
source	<xs:element name="Entlassungsgrund" type="kh:Entlassungsgrund"> <xs:annotation> <xs:documentation>GEK02: Grund der Entlassung/ Verlegung MD</xs:documentation> </xs:annotation> </xs:element>

element Begutachtung/Stellungnahme/Pruefung/Entlassung/MD_DRG

diagram							
namespace	http://www.aok-systems.de/xml-schema/mdk-kh-standard_V07.00						
properties	minOcc	0	maxOcc	1	content	complex	
attributes	Name	Type	Use	Default	Fixed	Annotation	
	DRG	derived by: DRG	optional			documentation GEK03: DRG-MD	
	relativgewicht	derived by: xs:decimal	optional			documentation GEK04: Eff. Relativgewicht der DRG-MD	
annotation	documentation GEK03-04						
source	<xs:element name="MD_DRG" minOccurs="0"> <xs:annotation> <xs:documentation>GEK03-04</xs:documentation> </xs:annotation> <xs:complexType> <xs:attribute name="DRG" use="optional"> <xs:annotation> <xs:documentation>GEK03: DRG-MD</xs:documentation> </xs:annotation> <xs:simpleType> <xs:restriction base="kh:DRG"/> </xs:simpleType> </xs:attribute> <xs:attribute name="relativgewicht" use="optional"> <xs:annotation> <xs:documentation>GEK04: Eff. Relativgewicht der DRG-MD</xs:documentation> </xs:annotation> <xs:simpleType> <xs:restriction base="xs:decimal">						

	<pre> <xs: totalDigits value="8"/> <xs: fractionDigits value="3"/> <xs: maxExclusive value="100000"/> </xs: restriction> </xs: simpleType> </xs: attribute> </xs: complexType> </xs: element> </pre>
--	--

attribute Begutachtung/Stellungnahme/Pruefung/Entlassung/MD_DRG/@DRG

type	restriction of DRG						
properties	use optional						
facets	<table border="1"> <thead> <tr> <th>Kind</th> <th>Value</th> <th>Annotation</th> </tr> </thead> <tbody> <tr> <td>length</td> <td>4</td> <td></td> </tr> </tbody> </table>	Kind	Value	Annotation	length	4	
Kind	Value	Annotation					
length	4						
annotation	documentation GEK03: DRG-MD						
source	<pre> <xs: attribute name="DRG" use="optional "> <xs: annotation> <xs: documentation>GEK03: DRG-MD</xs: documentation> </xs: annotation> <xs: simpleType> <xs: restriction base="kh: DRG" /> </xs: simpleType> </xs: attribute> </pre>						

attribute Begutachtung/Stellungnahme/Pruefung/Entlassung/MD_DRG/@relativgewicht

type	restriction of xs:decimal												
properties	use optional												
facets	<table border="1"> <thead> <tr> <th>Kind</th> <th>Value</th> <th>Annotation</th> </tr> </thead> <tbody> <tr> <td>maxExclusive</td> <td>100000</td> <td></td> </tr> <tr> <td>totalDigits</td> <td>8</td> <td></td> </tr> <tr> <td>fractionDigits</td> <td>3</td> <td></td> </tr> </tbody> </table>	Kind	Value	Annotation	maxExclusive	100000		totalDigits	8		fractionDigits	3	
Kind	Value	Annotation											
maxExclusive	100000												
totalDigits	8												
fractionDigits	3												
annotation	documentation GEK04: Eff. Relativgewicht der DRG-MD												
source	<pre> <xs: attribute name="relativgewicht" use="optional "> <xs: annotation> <xs: documentation>GEK04: Eff. Relativgewicht der DRG-MD</xs: documentation> </xs: annotation> <xs: simpleType> <xs: restriction base="xs: decimal "> <xs: totalDigits value="8"/> <xs: fractionDigits value="3"/> <xs: maxExclusive value="100000"/> </xs: restriction> </xs: simpleType> </xs: attribute> </pre>												

element Begutachtung/Stellungnahme/Pruefung/Entlassung/MD_PEPP

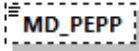
diagram	 GEK09: PEPP MD
namespace	http://www.aok-systems.de/xml-schema/mdk-kh-standard_V07.00
type	restriction of xs:string
properties	minOcc 0 maxOcc 1 content simple
facets	Kind Value Annotation minLength 1 maxLength 5
annotation	documentation GEK09: PEPP MD
source	<pre><xs:element name="MD_PEPP" minOccurs="0"> <xs:annotation> <xs:documentation>GEK09: PEPP MD</xs:documentation> </xs:annotation> <xs:simpleType> <xs:restriction base="xs:string"> <xs:maxLength value="5"/> <xs:minLength value="1"/> </xs:restriction> </xs:simpleType> </xs:element></pre>

element Begutachtung/Stellungnahme/Pruefung/Entlassung/Bewertungsrelation

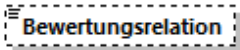
diagram	 GEK10: Eff. Bewertungsrelation der PEPP MD
namespace	http://www.aok-systems.de/xml-schema/mdk-kh-standard_V07.00
type	restriction of xs:decimal
properties	minOcc 0 maxOcc 1 content simple
facets	Kind Value Annotation maxExclusive 10000 totalDigits 8 fractionDigits 4
annotation	documentation GEK10: Eff. Bewertungsrelation der PEPP MD
source	<pre><xs:element name="Bewertungsrelation" minOccurs="0"> <xs:annotation> <xs:documentation>GEK10: Eff. Bewertungsrelation der PEPP MD</xs:documentation></pre>

	<pre> </xs: annotation> <xs: simpleType> <xs: restriction base="xs: decimal"> <xs: totalDigits value="8"/> <xs: fractionDigits value="4"/> <xs: maxExclusive value="10000"/> </xs: restriction> </xs: simpleType> </xs: element> </pre>
--	---

element Begutachtung/Stellungnahme/Pruefung/Entlassung/Beatmungsstunden

diagram										
namespace	http://www.aok-systems.de/xml-schema/mdk-kh-standard_V07.00									
type	restriction of xs:int									
properties	minOcc 0 maxOcc 1 content simple									
facets	<table border="1"> <thead> <tr> <th>Kind</th> <th>Value</th> <th>Annotation</th> </tr> </thead> <tbody> <tr> <td>minInclusive</td> <td>0</td> <td></td> </tr> <tr> <td>maxInclusive</td> <td>9999</td> <td></td> </tr> </tbody> </table>	Kind	Value	Annotation	minInclusive	0		maxInclusive	9999	
Kind	Value	Annotation								
minInclusive	0									
maxInclusive	9999									
annotation	documentation GEK05: Anzahl Beatmungsstunden									
source	<pre> <xs: element name="Beatmungsstunden" minOccurs="0"> <xs: annotation> <xs: documentation>GEK05: Anzahl Beatmungsstunden</xs: documentation> </xs: annotation> <xs: simpleType> <xs: restriction base="xs: int"> <xs: minInclusive value="0"/> <xs: maxInclusive value="9999"/> </xs: restriction> </xs: simpleType> </xs: element> </pre>									

element Begutachtung/Stellungnahme/Pruefung/Entlassung/Entbindung

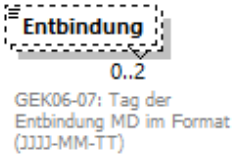
diagram	
namespace	http://www.aok-systems.de/xml-schema/mdk-kh-standard_V07.00
type	restriction of Datum Stp
properties	minOcc 0 maxOcc 2

	content simple									
facets	<table border="1"> <thead> <tr> <th>Kind</th> <th>Value</th> <th>Annotation</th> </tr> </thead> <tbody> <tr> <td>minInclusive</td> <td>1850-01-01</td> <td></td> </tr> <tr> <td>maxInclusive</td> <td>2099-12-31</td> <td></td> </tr> </tbody> </table>	Kind	Value	Annotation	minInclusive	1850-01-01		maxInclusive	2099-12-31	
Kind	Value	Annotation								
minInclusive	1850-01-01									
maxInclusive	2099-12-31									
annotation	documentation GEK06-07: Tag der Entbindung MD im Format (JJJJ-MM-TT)									
source	<pre><xs:element name="Entbindung" minOccurs="0" maxOccurs="2"> <xs:annotation> <xs:documentation>GEK06-07: Tag der Entbindung MD im Format (JJJJ-MM-TT)</xs:documentation> </xs:annotation> <xs:simpleType> <xs:restriction base="md:Datum_Stp"/> </xs:simpleType> </xs:element></pre>									

element Begutachtung/Stellungnahme/Pruefung/Entlassung/TOB

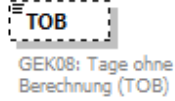
diagram										
namespace	http://www.aok-systems.de/xml-schema/mdk-kh-standard_V07.00									
type	Anzahl_Tage3									
properties	<table border="1"> <tbody> <tr> <td>minOcc</td> <td>0</td> </tr> <tr> <td>maxOcc</td> <td>1</td> </tr> <tr> <td>content</td> <td>simple</td> </tr> </tbody> </table>	minOcc	0	maxOcc	1	content	simple			
minOcc	0									
maxOcc	1									
content	simple									
facets	<table border="1"> <thead> <tr> <th>Kind</th> <th>Value</th> <th>Annotation</th> </tr> </thead> <tbody> <tr> <td>minInclusive</td> <td>0</td> <td></td> </tr> <tr> <td>maxInclusive</td> <td>999</td> <td></td> </tr> </tbody> </table>	Kind	Value	Annotation	minInclusive	0		maxInclusive	999	
Kind	Value	Annotation								
minInclusive	0									
maxInclusive	999									
annotation	documentation GEK08: Tage ohne Berechnung (TOB)									
source	<pre><xs:element name="TOB" type="kh:Anzahl_Tage3" minOccurs="0"> <xs:annotation> <xs:documentation>GEK08: Tage ohne Berechnung (TOB)</xs:documentation> </xs:annotation> </xs:element></pre>									

element Begutachtung/Stellungnahme/Pruefung/Entgelte

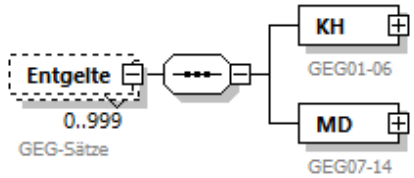
diagram					
namespace	http://www.aok-systems.de/xml-schema/mdk-kh-standard_V07.00				
properties	<table border="1"> <tbody> <tr> <td>minOcc</td> <td>0</td> </tr> <tr> <td>maxOcc</td> <td>999</td> </tr> </tbody> </table>	minOcc	0	maxOcc	999
minOcc	0				
maxOcc	999				

	content complex
children	KH MD
annotation	documentation GEG-Sätze
source	<pre> <xs:element name="Entgelte" minOccurs="0" maxOccurs="999"> <xs:annotation> <xs:documentation>GEG-Sätze</xs:documentation> </xs:annotation> <xs:complexType> <xs:sequence> <xs:element name="KH"> <xs:annotation> <xs:documentation>GEG01-06</xs:documentation> </xs:annotation> <xs:complexType> <xs:attribute name="entgeltart" type="kh:Entgeltart" use="optional"> <xs:annotation> <xs:documentation>GEG01: Entgeltart</xs:documentation> </xs:annotation> </xs:attribute> <xs:attribute name="betrag" use="optional"> <xs:annotation> <xs:documentation>GEG02: Entgeltbetrag </xs:documentation> </xs:annotation> <xs:simpleType> <xs:restriction base="xs:decimal"> <xs:fractionDigits value="2" fixed="false"/> <xs:totalDigits value="9"/> <xs:maxExclusive value="100000000"/> </xs:restriction> </xs:simpleType> </xs:attribute> <xs:attribute name="abrechnung_von" type="md:Datum_Stp" use="optional"> <xs:annotation> <xs:documentation>GEG03: Entgelt Abrechnung von im Format(JJJJ-MM-TT)</xs:documentation> </xs:annotation> </xs:attribute> <xs:attribute name="abrechnung_bis" type="md:Datum_Stp" use="optional"> <xs:annotation> <xs:documentation>GEG04: Entgelt Abrechnung bis im Format(JJJJ-MM-TT)</xs:documentation> </xs:annotation> </xs:attribute> <xs:attribute name="entgelt_anzahl" type="kh:Anzahl_Tage3" use="optional"> <xs:annotation> <xs:documentation>GEG05: Anzahl des Entgeltschlüssels</xs:documentation> </xs:annotation> </xs:attribute> <xs:attribute name="TOB" type="kh:Anzahl_Tage3" use="optional"> <xs:annotation> <xs:documentation>GEG06: Tage ohne </pre>

```

Berechnung/Behandlung</xs:documentation>
  </xs:annotation>
  </xs:attribute>
</xs:complexType>
</xs:element>
<xs:element name="MD">
  <xs:annotation>
    <xs:documentation>GEG07-14</xs:documentation>
  </xs:annotation>
  <xs:attribute name="entgeltart" type="kh:Entgeltart" use="optional">
    <xs:annotation>
      <xs:documentation>GEG07: Entgeltart MD</xs:documentation>
    </xs:annotation>
  </xs:attribute>
  <xs:attribute name="betrag" use="optional">
    <xs:annotation>
      <xs:documentation>GEG08: Entgeltbetrag MD</xs:documentation>
    </xs:annotation>
    <xs:simpleType>
      <xs:restriction base="xs:decimal">
        <xs:fractionDigits value="2" fixed="false"/>
        <xs:totalDigits value="9"/>
        <xs:maxExclusive value="100000000"/>
      </xs:restriction>
    </xs:simpleType>
  </xs:attribute>
  <xs:attribute name="abrechnung_von" type="md:Datum_Stp" use="optional">
    <xs:annotation>
      <xs:documentation>GEG09: Entgelt Abrechnung von MD im Format
(JJJJ-MM-TT)</xs:documentation>
    </xs:annotation>
  </xs:attribute>
  <xs:attribute name="abrechnung_bis" type="md:Datum_Stp" use="optional">
    <xs:annotation>
      <xs:documentation>GEG10: Entgelt Abrechnung bis MD im Format
(JJJJ-MM-TT)</xs:documentation>
    </xs:annotation>
  </xs:attribute>
  <xs:attribute name="entgelt_anzahl" type="kh:Anzahl_Tage3"
use="optional">
    <xs:annotation>
      <xs:documentation>GEG11: Anzahl des Entgeltschlüssels
MD</xs:documentation>
    </xs:annotation>
  </xs:attribute>
  <xs:attribute name="TOB" type="kh:Anzahl_Tage3" use="optional">
    <xs:annotation>
      <xs:documentation>GEG12: Tage ohne Berechnung/Behandlung
MD</xs:documentation>
    </xs:annotation>
  </xs:attribute>
  <xs:attribute name="antwort" type="kh:Antwortzeichen" use="required">
    <xs:annotation>
      <xs:documentation>GEG13: Antwort MD</xs:documentation>
    </xs:annotation>
  </xs:attribute>

```

```

</xs: annotation>
</xs: attribute>
<xs: attribute name="erlaeuterung" type="kh: Frei text_1024"
use="optional">
<xs: annotation>
<xs: documentation>GEG14: Erläuterungen MD</xs: documentation>
</xs: annotation>
</xs: attribute>
</xs: complexType>
</xs: element>
</xs: sequence>
</xs: complexType>
</xs: element>

```

element Begutachtung/Stellungnahme/Pruefung/Entgelte/KH

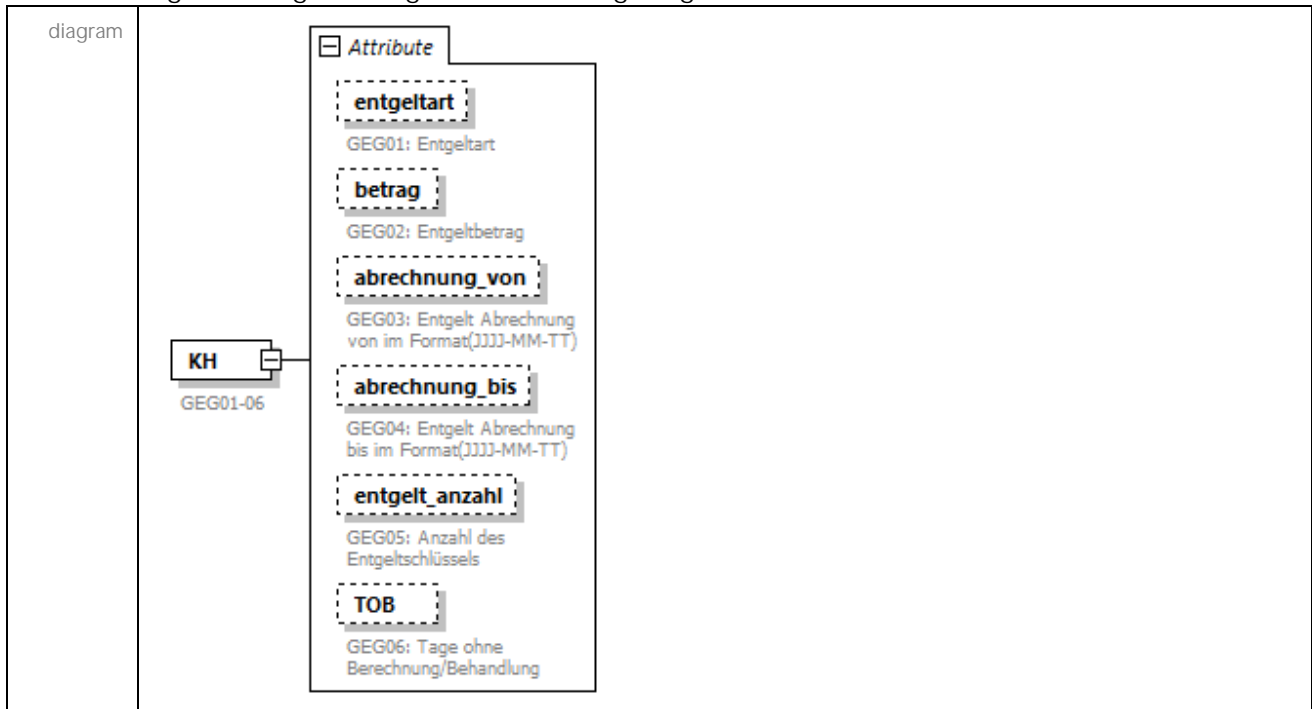

namespace http://www.aok-systems.de/xml-schema/mdk-kh-standard_V07.00

properties content complex

attributes	Name	Type	Use	Default	Fixed	Annotation
	entgeltart	Entgeltart	optional			documentation GEG01: Entgeltart
	betrag	derived by: xs:decimal	optional			documentation GEG02: Entgeltbetrag
	abrechnung_von	Datum_Stp	optional			documentation GEG03: Entgelt Abrechnung von im Format(JJJJ-MM-TT)
	abrechnung_bis	Datum_Stp	optional			documentation GEG04: Entgelt Abrechnung bis im Format(JJJJ-MM-TT)

	<p>entgelt_anzahl Anzahl_Tage3 optional</p> <p>TOB Anzahl_Tage3 optional</p>	<p>documentation GEG05: Anzahl des Entgeltschlüssels documentation GEG06: Tage ohne Berechnung/Behandlung</p>
annotation	documentation GEG01-06	
source	<pre> <xs:element name="KH"> <xs:annotation> <xs:documentation>GEG01-06</xs:documentation> </xs:annotation> <xs:complexType> <xs:attribute name="entgeltart" type="kh:Entgeltart" use="optional"> <xs:annotation> <xs:documentation>GEG01: Entgeltart</xs:documentation> </xs:annotation> </xs:attribute> <xs:attribute name="betrag" use="optional"> <xs:annotation> <xs:documentation>GEG02: Entgeltbetrag </xs:documentation> </xs:annotation> <xs:simpleType> <xs:restriction base="xs:decimal"> <xs:fractionDigits value="2" fixed="false"/> <xs:totalDigits value="9"/> <xs:maxExclusive value="100000000"/> </xs:restriction> </xs:simpleType> <xs:attribute name="abrechnung_von" type="md:Datum_Stp" use="optional"> <xs:annotation> <xs:documentation>GEG03: Entgelt Abrechnung von im Format(JJJJ-MM-TT)</xs:documentation> </xs:annotation> </xs:attribute> <xs:attribute name="abrechnung_bis" type="md:Datum_Stp" use="optional"> <xs:annotation> <xs:documentation>GEG04: Entgelt Abrechnung bis im Format(JJJJ-MM-TT)</xs:documentation> </xs:annotation> </xs:attribute> <xs:attribute name="entgelt_anzahl" type="kh:Anzahl_Tage3" use="optional"> <xs:annotation> <xs:documentation>GEG05: Anzahl des Entgeltschlüssels</xs:documentation> </xs:annotation> </xs:attribute> <xs:attribute name="TOB" type="kh:Anzahl_Tage3" use="optional"> <xs:annotation> <xs:documentation>GEG06: Tage ohne Berechnung/Behandlung</xs:documentation> </xs:annotation> </xs:attribute> </xs:complexType> </xs:element> </pre>	

attribute Begutachtung/Stellungnahme/Pruefung/Entgelte/KH/@entgeltart

type	Entgeltart									
properties	use optional									
facets	<table border="1"> <thead> <tr> <th>Kind</th> <th>Value</th> <th>Annotation</th> </tr> </thead> <tbody> <tr> <td>length</td> <td>8</td> <td></td> </tr> <tr> <td>pattern</td> <td>[0-9A-Z]{8}</td> <td></td> </tr> </tbody> </table>	Kind	Value	Annotation	length	8		pattern	[0-9A-Z]{8}	
Kind	Value	Annotation								
length	8									
pattern	[0-9A-Z]{8}									
annotation	documentation GEG01: Entgeltart									
source	<pre><xs:attribute name="entgeltart" type="kh:Entgeltart" use="optional"> <xs:annotation> <xs:documentation>GEG01: Entgeltart</xs:documentation> </xs:annotation> </xs:attribute></pre>									

attribute Begutachtung/Stellungnahme/Pruefung/Entgelte/KH/@betrag

type	restriction of xs:decimal												
properties	use optional												
facets	<table border="1"> <thead> <tr> <th>Kind</th> <th>Value</th> <th>Annotation</th> </tr> </thead> <tbody> <tr> <td>maxExclusive</td> <td>100000000</td> <td></td> </tr> <tr> <td>totalDigits</td> <td>9</td> <td></td> </tr> <tr> <td>fractionDigits</td> <td>2</td> <td></td> </tr> </tbody> </table>	Kind	Value	Annotation	maxExclusive	100000000		totalDigits	9		fractionDigits	2	
Kind	Value	Annotation											
maxExclusive	100000000												
totalDigits	9												
fractionDigits	2												
annotation	documentation GEG02: Entgeltbetrag												
source	<pre><xs:attribute name="betrag" use="optional"> <xs:annotation> <xs:documentation>GEG02: Entgeltbetrag </xs:documentation> </xs:annotation> <xs:simpleType> <xs:restriction base="xs:decimal"> <xs:fractionDigits value="2" fixed="false"/> <xs:totalDigits value="9"/> <xs:maxExclusive value="100000000"/> </xs:restriction> </xs:simpleType> </xs:attribute></pre>												

attribute Begutachtung/Stellungnahme/Pruefung/Entgelte/KH/@abrechnung_von

type	Datum_Stp									
properties	use optional									
facets	<table border="1"> <thead> <tr> <th>Kind</th> <th>Value</th> <th>Annotation</th> </tr> </thead> <tbody> <tr> <td>minInclusive</td> <td>1850-01-01</td> <td></td> </tr> <tr> <td>maxInclusive</td> <td>2099-12-31</td> <td></td> </tr> </tbody> </table>	Kind	Value	Annotation	minInclusive	1850-01-01		maxInclusive	2099-12-31	
Kind	Value	Annotation								
minInclusive	1850-01-01									
maxInclusive	2099-12-31									
annotation	documentation									

	GEG03: Entgelt Abrechnung von im Format(JJJJ-MM-TT)
source	<pre><xs:attribute name="abrechnung_von" type="md: Datum_Stp" use="optional "> <xs:annotation> <xs:documentation>GEG03: Entgelt Abrechnung von im Format(JJJJ-MM-TT)</xs:documentation> </xs:annotation> </xs:attribute></pre>

attribute Begutachtung/Stellungnahme/Pruefung/Entgelte/KH/@abrechnung_bis

type	Datum_Stp									
properties	use optional									
facets	<table border="1"> <thead> <tr> <th>Kind</th> <th>Value</th> <th>Annotation</th> </tr> </thead> <tbody> <tr> <td>minInclusive</td> <td>1850-01-01</td> <td></td> </tr> <tr> <td>maxInclusive</td> <td>2099-12-31</td> <td></td> </tr> </tbody> </table>	Kind	Value	Annotation	minInclusive	1850-01-01		maxInclusive	2099-12-31	
Kind	Value	Annotation								
minInclusive	1850-01-01									
maxInclusive	2099-12-31									
annotation	documentation GEG04: Entgelt Abrechnung bis im Format(JJJJ-MM-TT)									
source	<pre><xs:attribute name="abrechnung_bis" type="md: Datum_Stp" use="optional "> <xs:annotation> <xs:documentation>GEG04: Entgelt Abrechnung bis im Format(JJJJ-MM-TT)</xs:documentation> </xs:annotation> </xs:attribute></pre>									

attribute Begutachtung/Stellungnahme/Pruefung/Entgelte/KH/@entgelt_anzahl

type	Anzahl_Tage3									
properties	use optional									
facets	<table border="1"> <thead> <tr> <th>Kind</th> <th>Value</th> <th>Annotation</th> </tr> </thead> <tbody> <tr> <td>minInclusive</td> <td>0</td> <td></td> </tr> <tr> <td>maxInclusive</td> <td>999</td> <td></td> </tr> </tbody> </table>	Kind	Value	Annotation	minInclusive	0		maxInclusive	999	
Kind	Value	Annotation								
minInclusive	0									
maxInclusive	999									
annotation	documentation GEG05: Anzahl des Entgeltschlüssels									
source	<pre><xs:attribute name="entgelt_anzahl" type="kh: Anzahl_Tage3" use="optional "> <xs:annotation> <xs:documentation>GEG05: Anzahl des Entgeltschlüssels</xs:documentation> </xs:annotation> </xs:attribute></pre>									

attribute Begutachtung/Stellungnahme/Pruefung/Entgelte/KH/@TOB

type	Anzahl_Tage3									
properties	use optional									
facets	<table border="1"> <thead> <tr> <th>Kind</th> <th>Value</th> <th>Annotation</th> </tr> </thead> <tbody> <tr> <td>minInclusive</td> <td>0</td> <td></td> </tr> <tr> <td>maxInclusive</td> <td>999</td> <td></td> </tr> </tbody> </table>	Kind	Value	Annotation	minInclusive	0		maxInclusive	999	
Kind	Value	Annotation								
minInclusive	0									
maxInclusive	999									

annotation	documentation GEG06: Tage ohne Berechnung/Behandlung
source	<xs:attribute name="TOB" type="kh:Anzahl_Tage3" use="optional"> <xs:annotation> <xs:documentation>GEG06: Tage ohne Berechnung/Behandlung</xs:documentation> </xs:annotation> </xs:attribute>

element Begutachtung/Stellungnahme/Pruefung/Entgelte/MD

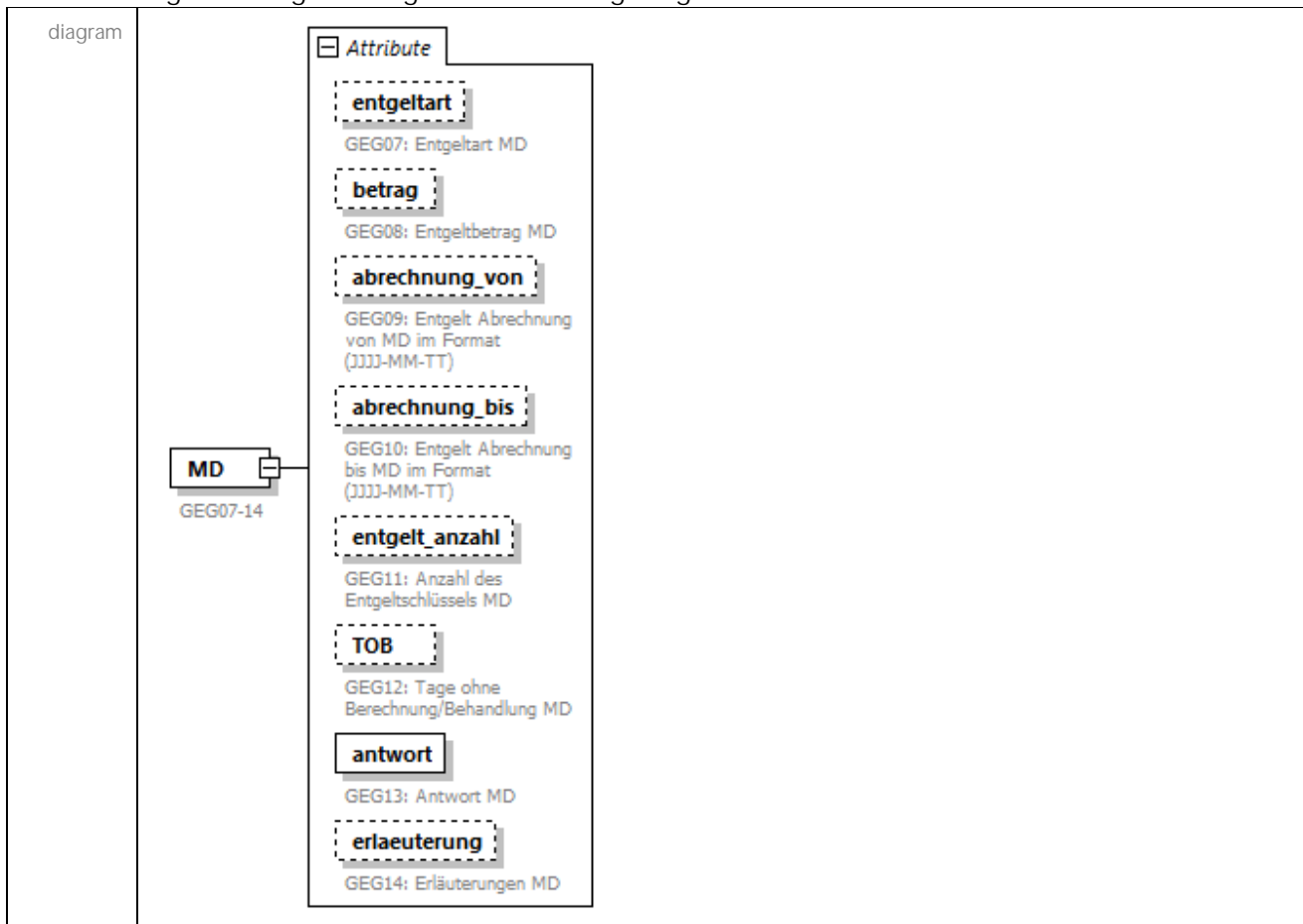

namespace	http://www.aok-systems.de/xml-schema/mdk-kh-standard_V07.00					
properties	content complex					
attributes	Name	Type	Use	Default	Fixed	Annotation
	entgeltart	Entgeltart	optional			documentation GEG07: Entgeltart MD
	betrag	derived by: xs:decimal	optional			documentation GEG08: Entgeltbetrag MD
	abrechnung_von	Datum_Stp	optional			documentation GEG09: Entgelt Abrechnung von MD im Format (JJJJ-MM-TT)
	abrechnung_bis	Datum_Stp	optional			documentation GEG10: Entgelt Abrechnung bis MD im Format (JJJJ-MM-TT)

	<p>entgelt_anzahl Anzahl_Tage3 optional</p> <p>IOB Anzahl_Tage3 optional</p> <p>antwort Antwortzeichen required</p> <p>erlaeuterung Freitext_1024 optional</p>	<p>GEG10: Entgelt Abrechnung bis MD im Format (JJJJ-MM-TT) documentation GEG11: Anzahl des Entgeltschlüssels MD documentation GEG12: Tage ohne Berechnung/Behandlung MD documentation GEG13: Antwort MD documentation GEG14: Erläuterungen MD</p>
<p>annotation</p>	<p>documentation GEG07-14</p>	
<p>source</p>	<pre> <xs:element name="MD"> <xs:annotation> <xs:documentation>GEG07-14</xs:documentation> </xs:annotation> <xs:complexType> <xs:attribute name="entgeltart" type="kh:Entgeltart" use="optional"> <xs:annotation> <xs:documentation>GEG07: Entgeltart MD</xs:documentation> </xs:annotation> </xs:attribute> <xs:attribute name="betrag" use="optional"> <xs:annotation> <xs:documentation>GEG08: Entgeltbetrag MD</xs:documentation> </xs:annotation> </xs:attribute> <xs:simpleType> <xs:restriction base="xs:decimal"> <xs:fractionDigits value="2" fixed="false"/> <xs:totalDigits value="9"/> <xs:maxExclusive value="100000000"/> </xs:restriction> </xs:simpleType> </xs:attribute> <xs:attribute name="abrechnung_von" type="md:Datum_Stp" use="optional"> <xs:annotation> <xs:documentation>GEG09: Entgelt Abrechnung von MD im Format (JJJJ-MM-TT)</xs:documentation> </xs:annotation> </xs:attribute> <xs:attribute name="abrechnung_bis" type="md:Datum_Stp" use="optional"> <xs:annotation> <xs:documentation>GEG10: Entgelt Abrechnung bis MD im Format (JJJJ-MM-TT)</xs:documentation> </xs:annotation> </xs:attribute> <xs:attribute name="entgelt_anzahl" type="kh:Anzahl_Tage3" use="optional"> <xs:annotation> <xs:documentation>GEG11: Anzahl des Entgeltschlüssels MD</xs:documentation> </xs:annotation> </xs:attribute> </xs:complexType> </xs:element> </pre>	

	<pre> </xs:attribute> <xs:attribute name="TOB" type="kh: Anzahl_Tage3" use="optional "> <xs:annotation> <xs:documentation>GEG12: Tage ohne Berechnung/Behandlung MD</xs:documentation> </xs:annotation> </xs:attribute> <xs:attribute name="antwort" type="kh: Antwortzeichen" use="required"> <xs:annotation> <xs:documentation>GEG13: Antwort MD</xs:documentation> </xs:annotation> </xs:attribute> <xs:attribute name="erlaeuterung" type="kh: Freitext_1024" use="optional "> <xs:annotation> <xs:documentation>GEG14: Erläuterungen MD</xs:documentation> </xs:annotation> </xs:attribute> </xs:complexType> </xs:element> </pre>
--	---

attribute Begutachtung/Stellungnahme/Pruefung/Entgelte/MD/@entgeltart

type	Entgeltart									
properties	use optional									
facets	<table border="1"> <thead> <tr> <th>Kind</th> <th>Value</th> <th>Annotation</th> </tr> </thead> <tbody> <tr> <td>length</td> <td>8</td> <td></td> </tr> <tr> <td>pattern</td> <td>[0-9A-Z]{8}</td> <td></td> </tr> </tbody> </table>	Kind	Value	Annotation	length	8		pattern	[0-9A-Z]{8}	
Kind	Value	Annotation								
length	8									
pattern	[0-9A-Z]{8}									
annotation	documentation GEG07: Entgeltart MD									
source	<pre> <xs:attribute name="entgeltart" type="kh: Entgeltart" use="optional "> <xs:annotation> <xs:documentation>GEG07: Entgeltart MD</xs:documentation> </xs:annotation> </xs:attribute> </pre>									

attribute Begutachtung/Stellungnahme/Pruefung/Entgelte/MD/@betrag

type	restriction of xs:decimal												
properties	use optional												
facets	<table border="1"> <thead> <tr> <th>Kind</th> <th>Value</th> <th>Annotation</th> </tr> </thead> <tbody> <tr> <td>maxExclusive</td> <td>100000000</td> <td></td> </tr> <tr> <td>totalDigits</td> <td>9</td> <td></td> </tr> <tr> <td>fractionDigits</td> <td>2</td> <td></td> </tr> </tbody> </table>	Kind	Value	Annotation	maxExclusive	100000000		totalDigits	9		fractionDigits	2	
Kind	Value	Annotation											
maxExclusive	100000000												
totalDigits	9												
fractionDigits	2												
annotation	documentation GEG08: Entgeltbetrag MD												
source	<pre> <xs:attribute name="betrag" use="optional "> <xs:annotation> <xs:documentation>GEG08: Entgeltbetrag MD</xs:documentation> </xs:annotation> </pre>												

	<pre> <xs:simpleType> <xs:restriction base="xs:decimal"> <xs:fractionDigits value="2" fixed="false"/> <xs:totalDigits value="9"/> <xs:maxExclusive value="100000000"/> </xs:restriction> </xs:simpleType> </xs:attribute> </pre>
--	--

attribute Begutachtung/Stellungnahme/Pruefung/Entgelte/MD/@abrechnung_von

type	Datum_Stp									
properties	use optional									
facets	<table border="1"> <thead> <tr> <th>Kind</th> <th>Value</th> <th>Annotation</th> </tr> </thead> <tbody> <tr> <td>minInclusive</td> <td>1850-01-01</td> <td></td> </tr> <tr> <td>maxInclusive</td> <td>2099-12-31</td> <td></td> </tr> </tbody> </table>	Kind	Value	Annotation	minInclusive	1850-01-01		maxInclusive	2099-12-31	
Kind	Value	Annotation								
minInclusive	1850-01-01									
maxInclusive	2099-12-31									
annotation	documentation GEG09: Entgelt Abrechnung von MD im Format (JJJJ-MM-TT)									
source	<pre> <xs:attribute name="abrechnung_von" type="md: Datum_Stp" use="optional"> <xs:annotation> <xs:documentation>GEG09: Entgelt Abrechnung von MD im Format (JJJJ-MM-TT)</xs:documentation> </xs:annotation> </xs:attribute> </pre>									

attribute Begutachtung/Stellungnahme/Pruefung/Entgelte/MD/@abrechnung_bis

type	Datum_Stp									
properties	use optional									
facets	<table border="1"> <thead> <tr> <th>Kind</th> <th>Value</th> <th>Annotation</th> </tr> </thead> <tbody> <tr> <td>minInclusive</td> <td>1850-01-01</td> <td></td> </tr> <tr> <td>maxInclusive</td> <td>2099-12-31</td> <td></td> </tr> </tbody> </table>	Kind	Value	Annotation	minInclusive	1850-01-01		maxInclusive	2099-12-31	
Kind	Value	Annotation								
minInclusive	1850-01-01									
maxInclusive	2099-12-31									
annotation	documentation GEG10: Entgelt Abrechnung bis MD im Format (JJJJ-MM-TT)									
source	<pre> <xs:attribute name="abrechnung_bis" type="md: Datum_Stp" use="optional"> <xs:annotation> <xs:documentation>GEG10: Entgelt Abrechnung bis MD im Format (JJJJ-MM-TT)</xs:documentation> </xs:annotation> </xs:attribute> </pre>									

attribute Begutachtung/Stellungnahme/Pruefung/Entgelte/MD/@entgelt_anzahl

type	Anzahl_Tage3						
properties	use optional						
facets	<table border="1"> <thead> <tr> <th>Kind</th> <th>Value</th> <th>Annotation</th> </tr> </thead> <tbody> <tr> <td>minInclusive</td> <td>0</td> <td></td> </tr> </tbody> </table>	Kind	Value	Annotation	minInclusive	0	
Kind	Value	Annotation					
minInclusive	0						

	maxInclusive 999
annotation	documentation GEG11: Anzahl des Entgeltschlüssels MD
source	<xs:attribute name="entgeltanzahl" type="kh:Anzahl_Tage3" use="optional"> <xs:annotation> <xs:documentation>GEG11: Anzahl des Entgeltschlüssels MD</xs:documentation> </xs:annotation> </xs:attribute>

attribute Begutachtung/Stellungnahme/Pruefung/Entgelte/MD/@TOB

type	Anzahl_Tage3									
properties	use optional									
facets	<table border="1"> <thead> <tr> <th>Kind</th> <th>Value</th> <th>Annotation</th> </tr> </thead> <tbody> <tr> <td>minInclusive</td> <td>0</td> <td></td> </tr> <tr> <td>maxInclusive</td> <td>999</td> <td></td> </tr> </tbody> </table>	Kind	Value	Annotation	minInclusive	0		maxInclusive	999	
Kind	Value	Annotation								
minInclusive	0									
maxInclusive	999									
annotation	documentation GEG12: Tage ohne Berechnung/Behandlung MD									
source	<xs:attribute name="TOB" type="kh:Anzahl_Tage3" use="optional"> <xs:annotation> <xs:documentation>GEG12: Tage ohne Berechnung/Behandlung MD</xs:documentation> </xs:annotation> </xs:attribute>									

attribute Begutachtung/Stellungnahme/Pruefung/Entgelte/MD/@antwort

type	Antwortzeichen															
properties	use required															
facets	<table border="1"> <thead> <tr> <th>Kind</th> <th>Value</th> <th>Annotation</th> </tr> </thead> <tbody> <tr> <td>enumeration</td> <td>0</td> <td></td> </tr> <tr> <td>enumeration</td> <td>1</td> <td></td> </tr> <tr> <td>enumeration</td> <td>2</td> <td></td> </tr> <tr> <td>enumeration</td> <td>9</td> <td></td> </tr> </tbody> </table>	Kind	Value	Annotation	enumeration	0		enumeration	1		enumeration	2		enumeration	9	
Kind	Value	Annotation														
enumeration	0															
enumeration	1															
enumeration	2															
enumeration	9															
annotation	documentation GEG13: Antwort MD															
source	<xs:attribute name="antwort" type="kh:Antwortzeichen" use="required"> <xs:annotation> <xs:documentation>GEG13: Antwort MD</xs:documentation> </xs:annotation> </xs:attribute>															

attribute Begutachtung/Stellungnahme/Pruefung/Entgelte/MD/@erlaeuterung

type	Freitext_1024			
properties	use optional			
facets	<table border="1"> <thead> <tr> <th>Kind</th> <th>Value</th> <th>Annotation</th> </tr> </thead> <tbody> </tbody> </table>	Kind	Value	Annotation
Kind	Value	Annotation		

	minLength 1 maxLength 1024
annotation	documentation GEG14: Erläuterungen MD
source	<pre><xs:attribute name="erläuterung" type="kh:Frei_text_1024" use="optional"> <xs:annotation> <xs:documentation>GEG14: Erläuterungen MD</xs:documentation> </xs:annotation> </xs:attribute></pre>

element Begutachtung/Stellungnahme/Pruefung/Aktenzeichen_anderer_Begutachtungsfall

diagram	
namespace	http://www.aok-systems.de/xml-schema/mdk-kh-standard_V07.00
type	Aktenzeichen_anderer_Begutachtungsfall_Ctp
properties	minOcc 0 maxOcc 9 content complex
children	Aktenzeichen_Fallnummer
annotation	documentation AAB: Aktenzeichen anderer Begutachtungsfall
source	<pre><xs:element name="Aktenzeichen_anderer_Begutachtungsfall" type="md:Aktenzeichen_anderer_Begutachtungsfall_Ctp" minOccurs="0" maxOccurs="9"> <xs:annotation> <xs:documentation>AAB: Aktenzeichen anderer Begutachtungsfall</xs:documentation> </xs:annotation> </xs:element></pre>

element Begutachtung/Stellungnahme/Pruefung/Angef_Gelief_Unterlagen

<p>diagram</p>	
<p>namespace</p>	<p>http://www.aok-systems.de/xml-schema/mdk-kh-standard_V07.00</p>
<p>properties</p>	<p>minOcc 0 maxOcc 9999 content complex</p>
<p>children</p>	<p>Unterlagen_Bezeichnung Datum_Anforderung Bereitstellung Dokumententyp Datum_Bereitstellung Hashwert Anmerkungen</p>
<p>annotation</p>	<p>documentation AGU-Sätze</p>
<p>source</p>	<pre><xs:element name="Angef_Gelief_Unterlagen" minOccurs="0" maxOccurs="9999"> <xs:annotation> <xs:documentation>AGU-Sätze</xs:documentation> </xs:annotation> <xs:complexType> <xs:sequence> <xs:element name="Unterlagen_Bezeichnung" type="kh:Frei_text_1024" minOccurs="1"> <xs:annotation> <xs:documentation>AGU01: Unterlagen Bezeichnung</xs:documentation> </xs:annotation> </xs:element> <xs:element name="Datum_Anforderung" type="md:Datum_Stp" minOccurs="0"> <xs:annotation> <xs:documentation>AGU02: Datum der Anforderung im Format (JJJJ-MM-TT)</xs:documentation> </xs:annotation> </xs:element> </xs:sequence> </xs:complexType> </xs:element></pre>

```

</xs:element>
<xs:element name="Bereitstellung" type="kh:Bereitstellung_Unterlagen"
minOccurs="1">
  <xs:annotation>
    <xs:documentation>AGU03: Bereitstellung (Schlüssel
U)</xs:documentation>
  </xs:annotation>
</xs:element>
<xs:element name="Dokumententyp" minOccurs="1">
  <xs:annotation>
    <xs:documentation>AGU04: Dokumententyp nach eVV</xs:documentation>
  </xs:annotation>
  <xs:simpleType>
    <xs:restriction base="xs:string">
      <xs:length value="8"/>
    </xs:restriction>
  </xs:simpleType>
</xs:element>
<xs:element name="Datum_Bereitstellung" type="md:Datum_Stp" minOccurs="0">
  <xs:annotation>
    <xs:documentation>AGU05: Datum der Bereitstellung im Format
(JJJJ-MM-TT)</xs:documentation>
  </xs:annotation>
</xs:element>
<xs:element name="Hashwert" minOccurs="0">
  <xs:annotation>
    <xs:documentation>AGU06: Hashwert lt. MD-Portal</xs:documentation>
  </xs:annotation>
  <xs:simpleType>
    <xs:restriction base="xs:string">
      <xs:length value="32"/>
    </xs:restriction>
  </xs:simpleType>
</xs:element>
<xs:element name="Anmerkungen" type="kh:Freitext_1024" minOccurs="0">
  <xs:annotation>
    <xs:documentation>AGU07: Anmerkungen</xs:documentation>
  </xs:annotation>
</xs:element>
</xs:sequence>
</xs:complexType>
</xs:element>

```

element Begutachtung/Stellungnahme/Pruefung/Angef_Gelief_Unterlagen/Unterlagen_Bezeichnung

diagram	
namespace	http://www.aok-systems.de/xml-schema/mdk-kh-standard_V07.00
type	Freitext_1024
properties	content simple

facets	Kind Value Annotation minLength 1 maxLength 1024
annotation	documentation AGU01: Unterlagen Bezeichnung
source	<xs:element name="Unterlagen_Bezeichnung" type="kh:Frei text_1024" minOccurs="1"> <xs:annotation> <xs:documentation>AGU01: Unterlagen Bezeichnung</xs:documentation> </xs:annotation> </xs:element>

element Begutachtung/Stellungnahme/Pruefung/Angef_Gelief_Unterlagen/Datum_Anforderung

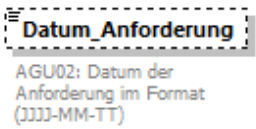
diagram	 AGU02: Datum der Anforderung im Format (JJJJ-MM-TT)
namespace	http://www.aok-systems.de/xml-schema/mdk-kh-standard_V07.00
type	Datum_Stp
properties	minOcc 0 maxOcc 1 content simple
facets	Kind Value Annotation minInclusive 1850-01-01 maxInclusive 2099-12-31
annotation	documentation AGU02: Datum der Anforderung im Format (JJJJ-MM-TT)
source	<xs:element name="Datum_Anforderung" type="md:Datum_Stp" minOccurs="0"> <xs:annotation> <xs:documentation>AGU02: Datum der Anforderung im Format (JJJJ-MM-TT)</xs:documentation> </xs:annotation> </xs:element>

element Begutachtung/Stellungnahme/Pruefung/Angef_Gelief_Unterlagen/Bereitstellung

diagram	 AGU03: Bereitstellung (Schlüssel U)
namespace	http://www.aok-systems.de/xml-schema/mdk-kh-standard_V07.00
type	Bereitstellung_Unterlagen
properties	content simple
facets	Kind Value Annotation enumeration 1 enumeration 2 enumeration 3

annotation	documentation AGU03: Bereitstellung (Schlüssel U)
source	<xs:element name="Bereitstellung" type="kh:Bereitstellung_Unterlagen" minOccurs="1"> <xs:annotation> <xs:documentation>AGU03: Bereitstellung (Schlüssel U)</xs:documentation> </xs:annotation> </xs:element>

element Begutachtung/Stellungnahme/Pruefung/Angef_Gelief_Unterlagen/Dokumententyp

diagram	 <p>Dokumententyp AGU04: Dokumententyp nach eVV</p>
namespace	http://www.aok-systems.de/xml-schema/mdk-kh-standard_V07.00
type	restriction of xs:string
properties	content simple
facets	Kind Value Annotation length 8
annotation	documentation AGU04: Dokumententyp nach eVV
source	<xs:element name="Dokumententyp" minOccurs="1"> <xs:annotation> <xs:documentation>AGU04: Dokumententyp nach eVV</xs:documentation> </xs:annotation> <xs:simpleType> <xs:restriction base="xs:string"> <xs:length value="8"/> </xs:restriction> </xs:simpleType> </xs:element>

element Begutachtung/Stellungnahme/Pruefung/Angef_Gelief_Unterlagen/Datum_Bereitstellung

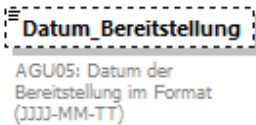
diagram	 <p>Datum_Bereitstellung AGU05: Datum der Bereitstellung im Format (JJJJ-MM-TT)</p>
namespace	http://www.aok-systems.de/xml-schema/mdk-kh-standard_V07.00
type	Datum_Stp
properties	minOcc 0 maxOcc 1 content simple
facets	Kind Value Annotation minInclusive 1850-01-01 maxInclusive 2099-12-31

annotation	documentation AGU05: Datum der Bereitstellung im Format (JJJJ-MM-TT)
source	<xs:element name="Datum_Bereitstellung" type="md:Datum_Stp" minOccurs="0"> <xs:annotation> <xs:documentation>AGU05: Datum der Bereitstellung im Format (JJJJ-MM-TT)</xs:documentation> </xs:annotation> </xs:element>

element Begutachtung/Stellungnahme/Pruefung/Angef_Gelief_Unterlagen/Hashwert

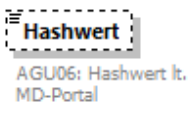
diagram	
namespace	http://www.aok-systems.de/xml-schema/mdk-kh-standard_V07.00
type	restriction of xs:string
properties	minOcc 0 maxOcc 1 content simple
facets	Kind Value Annotation length 32
annotation	documentation AGU06: Hashwert lt. MD-Portal
source	<xs:element name="Hashwert" minOccurs="0"> <xs:annotation> <xs:documentation>AGU06: Hashwert lt. MD-Portal</xs:documentation> </xs:annotation> <xs:simpleType> <xs:restriction base="xs:string"> <xs:length value="32"/> </xs:restriction> </xs:simpleType> </xs:element>

element Begutachtung/Stellungnahme/Pruefung/Angef_Gelief_Unterlagen/Anmerkungen

diagram	
namespace	http://www.aok-systems.de/xml-schema/mdk-kh-standard_V07.00
type	Freitext_1024
properties	minOcc 0 maxOcc 1 content simple
facets	Kind Value Annotation minLength 1 maxLength 1024

annotation	documentation AGU07: Anmerkungen
source	<xs:element name="Anmerkungen" type="kh:Frei text_1024" minOccurs="0"> <xs:annotation> <xs:documentation>AGU07: Anmerkungen</xs:documentation> </xs:annotation> </xs:element>

element Begutachtung/Zwischennachricht

diagram	
namespace	http://www.aok-systems.de/xml-schema/mdk-kh-standard_V07.00
properties	content complex
children	Fragen Pruefantrag Pruefgegenstaende
annotation	documentation Zwischennachricht an GKV
source	<pre> <xs:element name="Zwischennachricht"> <xs:annotation> <xs:documentation>Zwischennachricht an GKV</xs:documentation> </xs:annotation> <xs:complexType> <xs:sequence> <xs:element name="Fragen" type="kh:CT_Neuer_Pruefanlass" minOccurs="0"> <xs:annotation> <xs:documentation>Fragestellungen des MD</xs:documentation> </xs:annotation> <xs:unique name="key_frage_z"> <xs:selector xpath="kh:frage"/> <xs:field xpath="@frage_ID"/> </xs:unique> </xs:element> <xs:element name="Pruefantrag"> <xs:annotation> <xs:documentation>Prüfauftragsdatum</xs:documentation> </xs:annotation> <xs:complexType> <xs:annotation> <xs:documentation>Prüfauftrag</xs:documentation> </xs:annotation> <xs:attribute name="erledigungsart" type="kh:Gutachtenart" use="required"> <xs:annotation> <xs:documentation>Erledigungsart</xs:documentation> </xs:annotation> </xs:attribute> </xs:complexType> </xs:element> </xs:sequence> </xs:complexType> </xs:element> </pre>

```

        </xs: annotation>
        </xs: attribute>
        <xs: attribute name="aktenzeichen" type="md: Aktenzeichen_Stp"
use="required">
        <xs: annotation>
        <xs: documentation>GZN02: Aktenzeichen der
Krankenkasse</xs: documentation>
        </xs: annotation>
        </xs: attribute>
        <xs: attribute name="datum_anzeige" type="md: Datum_Stp" use="optional ">
        <xs: annotation>
        <xs: documentation>GZN03: Datum der Prüfanzeige im Format
(JJJJ-MM-TT)</xs: documentation>
        </xs: annotation>
        </xs: attribute>
        <xs: attribute name="datum_erweiterung" type="md: Datum_Stp"
use="optional ">
        <xs: annotation>
        <xs: documentation>GZN04: Datum Erweiterung des Prüfanlasses im Format
(JJJJ-MM-TT)</xs: documentation>
        </xs: annotation>
        </xs: attribute>
        <xs: attribute name="datum_beauftragung" type="md: Datum_Stp"
use="required">
        <xs: annotation>
        <xs: documentation>GZN05: Datum der Beauftragung im Format
(JJJJ-MM-TT)</xs: documentation>
        </xs: annotation>
        </xs: attribute>
        </xs: complexType>
</xs: element>
<xs: element name="Pruefgegenstaende" type="kh: CT_Pruefgegenstand"
minOccurs="0">
        <xs: annotation>
        <xs: documentation>PGS-Sätze: Prüfgegenstand</xs: documentation>
        </xs: annotation>
        </xs: element>
</xs: sequence>
</xs: complexType>
</xs: element>

```

element Begutachtung/Zwischennachricht/Fragen

diagram													
namespace	http://www.aok-systems.de/xml-schema/mdk-kh-standard_V07.00												
type	CT_Neuer_Pruefanlass												
properties	minOcc 0 maxOcc 1 content complex												
children	frage												
identity constraints	<table border="1"> <thead> <tr> <th></th> <th>Name</th> <th>Refer</th> <th>Selector</th> <th>Field(s)</th> <th>Annotation</th> </tr> </thead> <tbody> <tr> <td>unique</td> <td>key_frage_z</td> <td></td> <td>kh:frage</td> <td>@frage_ID</td> <td></td> </tr> </tbody> </table>		Name	Refer	Selector	Field(s)	Annotation	unique	key_frage_z		kh:frage	@frage_ID	
	Name	Refer	Selector	Field(s)	Annotation								
unique	key_frage_z		kh:frage	@frage_ID									
annotation	documentation Fragestellungen des MD												
source	<pre> <xs:element name="Fragen" type="kh:CT_Neuer_Pruefanlass" minOccurs="0"> <xs:annotation> <xs:documentation>Fragestellungen des MD</xs:documentation> </xs:annotation> <xs:unique name="key_frage_z"> <xs:selector xpath="kh:frage"/> <xs:field xpath="@frage_ID"/> </xs:unique> </xs:element> </pre>												

element Begutachtung/Zwischennachricht/Pruefantrag

<p>diagram</p>																																										
<p>namespace</p>	<p>http://www.aok-systems.de/xml-schema/mdk-kh-standard_V07.00</p>																																									
<p>properties</p>	<p>content complex</p>																																									
<p>attributes</p>	<table border="1"> <thead> <tr> <th>Name</th> <th>Type</th> <th>Use</th> <th>Default</th> <th>Fixed</th> <th>Annotation</th> </tr> </thead> <tbody> <tr> <td>erledigungsart</td> <td>Gutachtenart</td> <td>required</td> <td></td> <td></td> <td>documentation GZN01: Erledigungsart</td> </tr> <tr> <td>aktenzeichen</td> <td>Aktenzeichen_Stp</td> <td>required</td> <td></td> <td></td> <td>documentation GZN02: Aktenzeichen der Krankenkasse</td> </tr> <tr> <td>datum_anzeige</td> <td>Datum_Stp</td> <td>optional</td> <td></td> <td></td> <td>documentation GZN03: Datum der Prüfanzeige im Format (JJJ-MM-TT)</td> </tr> <tr> <td>datum_erweiterung</td> <td>Datum_Stp</td> <td>optional</td> <td></td> <td></td> <td>documentation GZN04: Datum Erweiterung des Prüfanlasses im Format (JJJ-MM-TT)</td> </tr> <tr> <td>datum_beauftragung</td> <td>Datum_Stp</td> <td>required</td> <td></td> <td></td> <td>documentation GZN05: Datum der Beauftragung im Format (JJJ-MM-TT)</td> </tr> </tbody> </table>	Name	Type	Use	Default	Fixed	Annotation	erledigungsart	Gutachtenart	required			documentation GZN01: Erledigungsart	aktenzeichen	Aktenzeichen_Stp	required			documentation GZN02: Aktenzeichen der Krankenkasse	datum_anzeige	Datum_Stp	optional			documentation GZN03: Datum der Prüfanzeige im Format (JJJ-MM-TT)	datum_erweiterung	Datum_Stp	optional			documentation GZN04: Datum Erweiterung des Prüfanlasses im Format (JJJ-MM-TT)	datum_beauftragung	Datum_Stp	required			documentation GZN05: Datum der Beauftragung im Format (JJJ-MM-TT)					
Name	Type	Use	Default	Fixed	Annotation																																					
erledigungsart	Gutachtenart	required			documentation GZN01: Erledigungsart																																					
aktenzeichen	Aktenzeichen_Stp	required			documentation GZN02: Aktenzeichen der Krankenkasse																																					
datum_anzeige	Datum_Stp	optional			documentation GZN03: Datum der Prüfanzeige im Format (JJJ-MM-TT)																																					
datum_erweiterung	Datum_Stp	optional			documentation GZN04: Datum Erweiterung des Prüfanlasses im Format (JJJ-MM-TT)																																					
datum_beauftragung	Datum_Stp	required			documentation GZN05: Datum der Beauftragung im Format (JJJ-MM-TT)																																					
<p>annotation</p>	<p>documentation Prüfauftragsdatum</p>																																									

source	<pre> <xs:element name="Pruefantrag"> <xs:annotation> <xs:documentation>Prüfauftragsdatum</xs:documentation> </xs:annotation> <xs:complexType> <xs:annotation> <xs:documentation>Prüfauftrag</xs:documentation> </xs:annotation> <xs:attribute name="erledigungsart" type="kh:Gutachtenart" use="required"> <xs:annotation> <xs:documentation>GZN01: Erledigungsart</xs:documentation> </xs:annotation> </xs:attribute> <xs:attribute name="aktenzeichen" type="md:Aktenzeichen_Stp" use="required"> <xs:annotation> <xs:documentation>GZN02: Aktenzeichen der Krankenkasse</xs:documentation> </xs:annotation> </xs:attribute> <xs:attribute name="datum_anzeige" type="md:Datum_Stp" use="optional"> <xs:annotation> <xs:documentation>GZN03: Datum der Prüfanzeige im Format (JJJJ-MM-TT)</xs:documentation> </xs:annotation> </xs:attribute> <xs:attribute name="datum_erweiterung" type="md:Datum_Stp" use="optional"> <xs:annotation> <xs:documentation>GZN04: Datum Erweiterung des Prüfanlasses im Format (JJJJ-MM-TT)</xs:documentation> </xs:annotation> </xs:attribute> <xs:attribute name="datum_beauftragung" type="md:Datum_Stp" use="required"> <xs:annotation> <xs:documentation>GZN05: Datum der Beauftragung im Format (JJJJ-MM-TT)</xs:documentation> </xs:annotation> </xs:attribute> </xs:complexType> </xs:element> </pre>
--------	--

attribute Begutachtung/Zwischennachricht/Pruefantrag/@erledigungsart

type	Gutachtenart																								
properties	use required																								
facets	<table border="1"> <thead> <tr> <th>Kind</th> <th>Value</th> <th>Annotation</th> </tr> </thead> <tbody> <tr> <td>enumeration</td> <td>01</td> <td></td> </tr> <tr> <td>enumeration</td> <td>02</td> <td></td> </tr> <tr> <td>enumeration</td> <td>03</td> <td></td> </tr> <tr> <td>enumeration</td> <td>04</td> <td></td> </tr> <tr> <td>enumeration</td> <td>05</td> <td></td> </tr> <tr> <td>enumeration</td> <td>06</td> <td></td> </tr> <tr> <td>enumeration</td> <td>07</td> <td></td> </tr> </tbody> </table>	Kind	Value	Annotation	enumeration	01		enumeration	02		enumeration	03		enumeration	04		enumeration	05		enumeration	06		enumeration	07	
Kind	Value	Annotation																							
enumeration	01																								
enumeration	02																								
enumeration	03																								
enumeration	04																								
enumeration	05																								
enumeration	06																								
enumeration	07																								

annotation	documentation GZN01: Erledigungsart
source	<xs: attribute name="erledigungsart" type="kh: Gutachtenart" use="required"> <xs: annotation> <xs: documentation>GZN01: Erledigungsart</xs: documentation> </xs: annotation> </xs: attribute>

attribute Begutachtung/Zwischennachricht/Pruefantrag/@aktenzeichen

type	Aktenzeichen_Stp												
properties	use required												
facets	<table border="1"> <thead> <tr> <th>Kind</th> <th>Value</th> <th>Annotation</th> </tr> </thead> <tbody> <tr> <td>minLength</td> <td>2</td> <td></td> </tr> <tr> <td>maxLength</td> <td>18</td> <td></td> </tr> <tr> <td>pattern</td> <td>\S+[\&#x0020;-&#x00FF;]*</td> <td></td> </tr> </tbody> </table>	Kind	Value	Annotation	minLength	2		maxLength	18		pattern	\S+[\ -ÿ]*	
Kind	Value	Annotation											
minLength	2												
maxLength	18												
pattern	\S+[\ -ÿ]*												
annotation	documentation GZN02: Aktenzeichen der Krankenkasse												
source	<xs: attribute name="aktenzeichen" type="md: Aktenzeichen_Stp" use="required"> <xs: annotation> <xs: documentation>GZN02: Aktenzeichen der Krankenkasse</xs: documentation> </xs: annotation> </xs: attribute>												

attribute Begutachtung/Zwischennachricht/Pruefantrag/@datum_anzeige

type	Datum_Stp									
properties	use optional									
facets	<table border="1"> <thead> <tr> <th>Kind</th> <th>Value</th> <th>Annotation</th> </tr> </thead> <tbody> <tr> <td>minInclusive</td> <td>1850-01-01</td> <td></td> </tr> <tr> <td>maxInclusive</td> <td>2099-12-31</td> <td></td> </tr> </tbody> </table>	Kind	Value	Annotation	minInclusive	1850-01-01		maxInclusive	2099-12-31	
Kind	Value	Annotation								
minInclusive	1850-01-01									
maxInclusive	2099-12-31									
annotation	documentation GZN03: Datum der Prüfanzzeige im Format (JJJJ-MM-TT)									
source	<xs: attribute name="datum_anzeige" type="md: Datum_Stp" use="optional"> <xs: annotation> <xs: documentation>GZN03: Datum der Prüfanzzeige im Format (JJJJ-MM-TT)</xs: documentation> </xs: annotation> </xs: attribute>									

attribute Begutachtung/Zwischennachricht/Pruefantrag/@datum_erweiterung

type	Datum_Stp									
properties	use optional									
facets	<table border="1"> <thead> <tr> <th>Kind</th> <th>Value</th> <th>Annotation</th> </tr> </thead> <tbody> <tr> <td>minInclusive</td> <td>1850-01-01</td> <td></td> </tr> <tr> <td>maxInclusive</td> <td>2099-12-31</td> <td></td> </tr> </tbody> </table>	Kind	Value	Annotation	minInclusive	1850-01-01		maxInclusive	2099-12-31	
Kind	Value	Annotation								
minInclusive	1850-01-01									
maxInclusive	2099-12-31									

annotation	documentation GZN04: Datum Erweiterung des Prüfanlasses im Format (JJJ-MM-TT)
source	<xs: attribute name="datum_erweiterung" type="md: Datum_Stp" use="optional "> <xs: annotation> <xs: documentation>GZN04: Datum Erweiterung des Prüfanlasses im Format (JJJ-MM-TT)</xs: documentation> </xs: annotation> </xs: attribute>

attribute Begutachtung/Zwischennachricht/Pruefantrag/@datum_beauftragung

type	Datum_Stp									
properties	use required									
facets	<table border="1"> <thead> <tr> <th>Kind</th> <th>Value</th> <th>Annotation</th> </tr> </thead> <tbody> <tr> <td>minInclusive</td> <td>1850-01-01</td> <td></td> </tr> <tr> <td>maxInclusive</td> <td>2099-12-31</td> <td></td> </tr> </tbody> </table>	Kind	Value	Annotation	minInclusive	1850-01-01		maxInclusive	2099-12-31	
Kind	Value	Annotation								
minInclusive	1850-01-01									
maxInclusive	2099-12-31									
annotation	documentation GZN05: Datum der Beauftragung im Format (JJJ-MM-TT)									
source	<xs: attribute name="datum_beauftragung" type="md: Datum_Stp" use="required"> <xs: annotation> <xs: documentation>GZN05: Datum der Beauftragung im Format (JJJ-MM-TT)</xs: documentation> </xs: annotation> </xs: attribute>									

element Begutachtung/Zwischennachricht/Pruefgegenstaende

diagram	
namespace	http://www.aok-systems.de/xml-schema/mdk-kh-standard_V07.00
type	CT_Pruefgegenstand
properties	minOcc 0 maxOcc 1 content complex
children	Pruefgegenstand
annotation	documentation PGS-Sätze: Prüfgegenstand
source	<xs: element name="Pruefgegenstaende" type="kh: CT_Pruefgegenstand" minOccurs="0"> <xs: annotation> <xs: documentation>PGS-Sätze: Prüfgegenstand</xs: documentation> </xs: annotation> </xs: element>

element Begutachtung/Zwischennachricht_ZEP

<p>diagram</p>	
<p>namespace</p>	<p>http://www.aok-systems.de/xml-schema/mdk-kh-standard_V07.00</p>
<p>properties</p>	<p>content complex</p>
<p>children</p>	<p>Anfrage_ZEP Pruefgegenstaende Fragen</p>
<p>annotation</p>	<p>documentation Zwischennachricht Anfrage Erweiterung des Prüfgegenstandes an GKV</p>
<p>source</p>	<pre> <xs:element name="Zwischennachricht_ZEP"> <xs:annotation> <xs:documentation>Zwischennachricht Anfrage Erweiterung des Prüfgegenstandes an GKV</xs:documentation> </xs:annotation> <xs:complexType> <xs:sequence> <xs:element name="Anfrage_ZEP" minOccurs="1"> <xs:annotation> <xs:documentation>Anfrage zur Erweiterung des Prüfgegenstandes (ZEP)</xs:documentation> </xs:annotation> <xs:complexType> <xs:sequence> <xs:element name="AZ_KK" minOccurs="1"> <xs:annotation> <xs:documentation>ZEP01: Aktenzeichen der Krankenkasse</xs:documentation> </xs:annotation> <xs:simpleType> <xs:restriction base="xs:string"> <xs:minLength value="2"/> <xs:maxLength value="18"/> </xs:restriction> </xs:simpleType> </xs:element> <xs:element name="Datum_Anfrage" type="md:Datum_Stp" minOccurs="1"> <xs:annotation> <xs:documentation>ZEP02: Datum der Anfrage zur Erweiterung des Prüfgegenstandes im Format (JJJJ-MM-TT)</xs:documentation> </xs:annotation> </xs:element> </xs:sequence> </xs:complexType> </xs:element> </xs:sequence> </xs:complexType> </xs:element> </pre>

	<pre> <xs:element name="Pruefgegenstaende" type="kh:CT_Pruefgegenstand"> <xs:annotation> <xs:documentation>PGS-Sätze: Prüfgegenstand</xs:documentation> </xs:annotation> <xs:unique name="key_preufgegenstand_zep"> <xs:selector xpath="kh:Pruefgegenstand"/> <xs:field xpath="@pruefgegenstand"/> </xs:unique> </xs:element> <xs:element name="Fragen" type="kh:CT_Neuer_Pruefanlass"> <xs:annotation> <xs:documentation>Neue Fragestellungen des MD zum beauftragten Fall I</xs:documentation> </xs:annotation> <xs:unique name="key_frage_zep"> <xs:selector xpath="kh:frage"/> <xs:field xpath="@frage_ID"/> </xs:unique> </xs:element> </xs:sequence> </xs:complexType> </xs:element> </pre>
--	---

element Begutachtung/Zwischennachricht_ZEP/Anfrage_ZEP

diagram	<pre> classDiagram class Anfrage_ZEP { <!-- } class AZ_KK { <!-- } class Datum_Anfrage { <!-- } Anfrage_ZEP --> Container Container --> AZ_KK Container --> Datum_Anfrage </pre>
namespace	http://www.aok-systems.de/xml-schema/mdk-kh-standard_V07.00
properties	content complex
children	AZ_KK Datum_Anfrage
annotation	documentation Anfrage zur Erweiterung des Prüfgegenstandes (ZEP)
source	<pre> <xs:element name="Anfrage_ZEP" minOccurs="1"> <xs:annotation> <xs:documentation>Anfrage zur Erweiterung des Prüfgegenstandes (ZEP)</xs:documentation> </xs:annotation> <xs:complexType> <xs:sequence> <xs:element name="AZ_KK" minOccurs="1"> <xs:annotation> <xs:documentation>ZEP01: Aktenzeichen der Krankenkasse</xs:documentation> </xs:annotation> </pre>

	<pre> <xs:simpleType> <xs:restriction base="xs:string"> <xs:minLength value="2"/> <xs:maxLength value="18"/> </xs:restriction> </xs:simpleType> </xs:element> <xs:element name="Datum_Anfrage" type="md:Datum_Stp" minOccurs="1"> <xs:annotation> <xs:documentation>ZEP02: Datum der Anfrage zur Erweiterung des Prüfgegenstandes im Format (JJJJ-MM-TT)</xs:documentation> </xs:annotation> </xs:element> </xs:sequence> </xs:complexType> </xs:element> </pre>
--	--

element Begutachtung/Zwischennachricht_ZEP/Anfrage_ZEP/AZ_KK

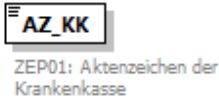
diagram										
namespace	http://www.aok-systems.de/xml-schema/mdk-kh-standard_V07.00									
type	restriction of xs:string									
properties	content simple									
facets	<table border="1"> <thead> <tr> <th>Kind</th> <th>Value</th> <th>Annotation</th> </tr> </thead> <tbody> <tr> <td>minLength</td> <td>2</td> <td></td> </tr> <tr> <td>maxLength</td> <td>18</td> <td></td> </tr> </tbody> </table>	Kind	Value	Annotation	minLength	2		maxLength	18	
Kind	Value	Annotation								
minLength	2									
maxLength	18									
annotation	documentation ZEP01: Aktenzeichen der Krankenkasse									
source	<pre> <xs:element name="AZ_KK" minOccurs="1"> <xs:annotation> <xs:documentation>ZEP01: Aktenzeichen der Krankenkasse</xs:documentation> </xs:annotation> <xs:simpleType> <xs:restriction base="xs:string"> <xs:minLength value="2"/> <xs:maxLength value="18"/> </xs:restriction> </xs:simpleType> </xs:element> </pre>									

element Begutachtung/Zwischennachricht_ZEP/Anfrage_ZEP/Datum_Anfrage

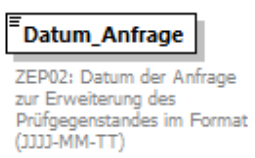
diagram										
namespace	http://www.aok-systems.de/xml-schema/mdk-kh-standard_V07.00									
type	Datum_Stp									
properties	content simple									
facets	<table border="1"> <thead> <tr> <th>Kind</th> <th>Value</th> <th>Annotation</th> </tr> </thead> <tbody> <tr> <td>minInclusive</td> <td>1850-01-01</td> <td></td> </tr> <tr> <td>maxInclusive</td> <td>2099-12-31</td> <td></td> </tr> </tbody> </table>	Kind	Value	Annotation	minInclusive	1850-01-01		maxInclusive	2099-12-31	
Kind	Value	Annotation								
minInclusive	1850-01-01									
maxInclusive	2099-12-31									
annotation	documentation ZEP02: Datum der Anfrage zur Erweiterung des Prüfgegenstandes im Format (JJJJ-MM-TT)									
source	<pre><xs:element name="Datum_Anfrage" type="md: Datum_Stp" minOccurs="1"> <xs:annotation> <xs:documentation>ZEP02: Datum der Anfrage zur Erweiterung des Prüfgegenstandes im Format (JJJJ-MM-TT)</xs:documentation> </xs:annotation> </xs:element></pre>									

element Begutachtung/Zwischennachricht_ZEP/Pruefgegenstaende

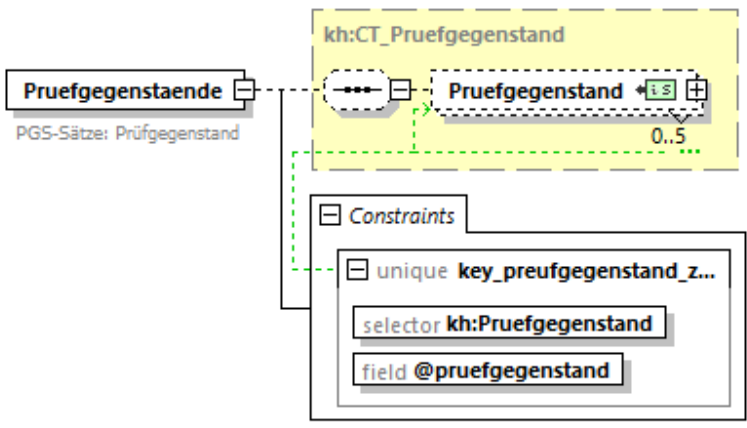
diagram													
namespace	http://www.aok-systems.de/xml-schema/mdk-kh-standard_V07.00												
type	CT_Pruefgegenstand												
properties	content complex												
children	Pruefgegenstand												
identity constraints	<table border="1"> <thead> <tr> <th>unique</th> <th>Name</th> <th>Refer</th> <th>Selector</th> <th>Field(s)</th> <th>Annotation</th> </tr> </thead> <tbody> <tr> <td></td> <td>key_preufgegenstand_zep</td> <td></td> <td>kh:Pruefgegenstand</td> <td>@pruefgegenstand</td> <td></td> </tr> </tbody> </table>	unique	Name	Refer	Selector	Field(s)	Annotation		key_preufgegenstand_zep		kh:Pruefgegenstand	@pruefgegenstand	
unique	Name	Refer	Selector	Field(s)	Annotation								
	key_preufgegenstand_zep		kh:Pruefgegenstand	@pruefgegenstand									
annotation	documentation PGS-Sätze: Prüfgegenstand												
source	<pre><xs:element name="Pruefgegenstaende" type="kh: CT_Pruefgegenstand"></pre>												

```

<xs: annotation>
  <xs: documentation>PGS-Sätze: Prüfgegenstand</xs: documentation>
</xs: annotation>
<xs: unique name="key_preufgegenstand_zep">
  <xs: selector xpath="kh:Pruefgegenstand"/>
  <xs: field xpath="@pruefgegenstand"/>
</xs: unique>
</xs: element>

```

element Begutachtung/Zwischennachricht_ZEP/Fragen

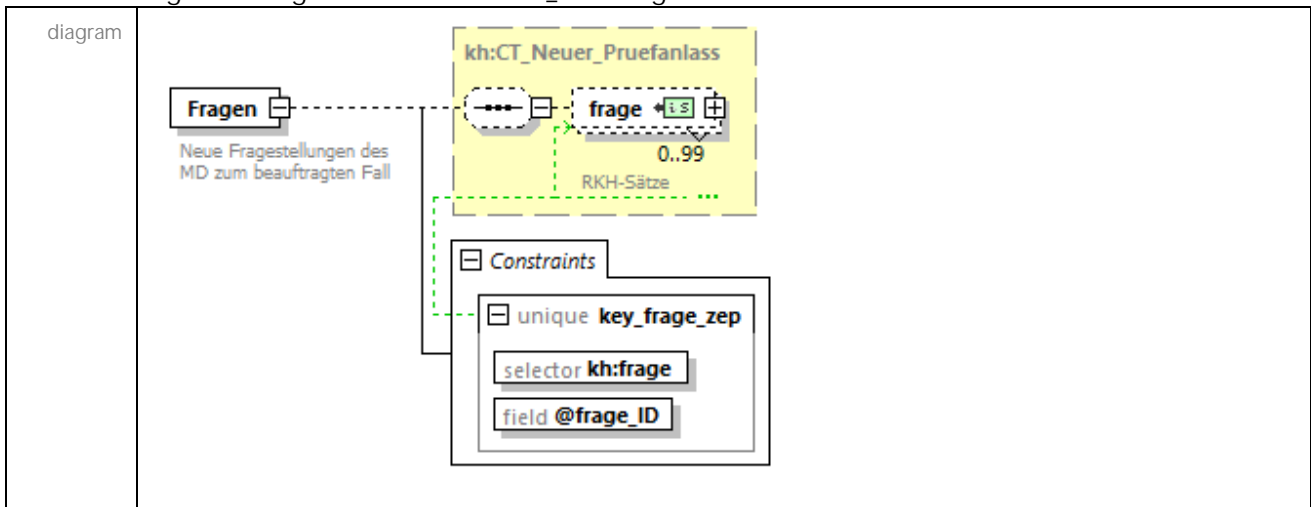

namespace	http://www.aok-systems.de/xml-schema/mdk-kh-standard_V07.00					
type	CT_Neuer_Pruefanlass					
properties	content complex					
children	frage					
identity constraints	unique	Name	Refer	Selector	Field(s)	Annotation
		key_frage_zep		kh:frage	@frage_ID	
annotation	documentation Neue Fragestellungen des MD zum beauftragten Fall					
source	<pre> <xs: element name="Fragen" type="kh:CT_Neuer_Pruefanlass"> <xs: annotation> <xs: documentation>Neue Fragestellungen des MD zum beauftragten Fall</xs: documentation> </xs: annotation> <xs: unique name="key_frage_zep"> <xs: selector xpath="kh:frage"/> <xs: field xpath="@frage_ID"/> </xs: unique> </xs: element> </pre>					

element Begutachtung/Dokument

diagram						
namespace	http://www.aok-systems.de/xml-schema/mdk-kh-standard_V07.00					
type	Dokument_Ctp					
properties	minOcc	0				
	maxOcc	9				
	content	complex				
attributes	Name	Type	Use	Default	Fixed	Annotation
	mime_type	derived by: Freitext Ohne Zeilenumbrueche Stp	required			documentation DOK01: MIME-Type
	name	derived by: Freitext Ohne Zeilenumbrueche Stp	required			documentation DOK02: Name des Dokumentes
	dok_typ	derived by: Dok Typ Stp	required			documentation DOK03: Dokumententyp
annotation	documentation DOK: Stammdaten Dokument					
source	<pre><xs:element name="Dokument" type="md:Dokument_Ctp" minOccurs="0" maxOccurs="9"> <xs:annotation> <xs:documentation>DOK: Stammdaten Dokument</xs:documentation> </xs:annotation> </xs:element></pre>					

complexType Adressat_Oder_Adresse_Ctp

<p>diagram</p>	
<p>namespace</p>	<p>MD:/xml-schema/MD-basis/3.5</p>
<p>children</p>	<p>Adressatsart Person Adresse Kontakt Besondere Hinweise</p>
<p>annotation</p>	<p>documentation AAV: Stammdaten Andere/r Adresse/Adressat als Versi cherter</p>
<p>source</p>	<pre><xs:complexType name="Adressat_Oder_Adresse_Ctp"> <xs:annotation> <xs:documentation>AAV: Stammdaten Andere/r Adresse/Adressat als Versi cherter</xs:documentation> </xs:annotation> <xs:sequence> <xs:element name="Adressatsart" type="Anderer_Adressat_Stp"> <xs:annotation> <xs:documentation>AAV01: (Schlüssel) Anderer Adressat als Versi cherter</xs:documentation> </xs:annotation> </xs:element> <xs:element name="Person"> <xs:annotation> <xs:documentation>AAV02: Name der Person bzw. Insti tuti on, AAV03: Vorname, AAV04: Ti tel, AAV05: Geschl echt, AAV14: Namenszusatz des anderen Adressaten, AAV18: Vorsatzwort</xs:documentation> </xs:annotation> </xs:element> <xs:element name="Adresse"> <xs:annotation> <xs:documentation>AAV06: Straße/ Hausnummer, AAV07: Zusatz zur Straße/ Hausnummer, AAV08: Postleitzahl, AAV09: Ort, AAV10: Ortsteil, AAV11: Internationales Länderkennzeichen, AAV19: Postfach </xs:documentation> </xs:annotation> </xs:element> <xs:element name="Kontakt"> <xs:annotation> <xs:documentation>AAV12: Telefon, AAV16: Telefax, AAV15: Mobiltelefon, AAV17: E-Mail-Adresse des anderen Adressaten </xs:documentation> </xs:annotation> </xs:element> <xs:element name="Besondere_Hinweise"> <xs:annotation> <xs:documentation>AAV13: Besondere Hinweise </xs:documentation> </xs:annotation> </xs:element> </xs:sequence> </xs:complexType></pre>

```

<xs:complexType>
  <xs:complexContent>
    <xs:restriction base="Person_Ctp">
      <xs:sequence>
        <xs:element name="Name" type="Name_Stp"/>
        <xs:element name="Vorname" type="Name_Stp" minOccurs="0"/>
        <xs:element name="Titel" type="Titel_Stp" minOccurs="0"/>
        <xs:element name="Geburtsdatum" type="Datum_Stp" minOccurs="0"
maxOccurs="0"/>
        <xs:element name="Geschlecht" type="Geschlecht_Stp" minOccurs="0"/>
        <xs:element name="Namenszusatz" type="Namenszusatz_Stp"
minOccurs="0"/>
        <xs:element name="Vorsatzwort" type="Vorsatzwort_Stp"
minOccurs="0"/>
        <xs:element name="Bes_schutz_Person" type="Bes_schutz_Person_Stp"
minOccurs="0" maxOccurs="0"/>
        <xs:element name="Erl_bes_schutz_Person"
type="Frei_text_Mit_Zeilenenum_1000_Stp" minOccurs="0" maxOccurs="0"/>
        <xs:element name="Genauigkeit_Geburtsdatum"
type="Gen_Geburtsdatum_Stp" minOccurs="0" maxOccurs="0"/>
      </xs:sequence>
    </xs:restriction>
  </xs:complexContent>
</xs:complexType>
</xs:element>
<xs:element name="Adresse">
  <xs:annotation>
    <xs:documentation>AAV06: Straße/ Hausnummer, AAV07: Zusatz zur Straße/
Hausnummer, AAV08: Postleitzahl, AAV09: Ort, AAV10: Ortsteil, AAV11: Internationales
Länderkennzeichen, AAV19: Postfach</xs:documentation>
  </xs:annotation>
  <xs:complexType>
    <xs:complexContent>
      <xs:restriction base="Adresse_Ctp">
        <xs:sequence>
          <xs:element name="Strasse_Hausnummer" type="Strasse_Hausnummer_Stp"
minOccurs="0"/>
          <xs:element name="Zusatz" type="Anschri ftenzusatz_Stp"
minOccurs="0"/>
          <xs:element name="PLZ" type="PLZ_Stp"/>
          <xs:element name="Ort" type="Ort_Stp"/>
          <xs:element name="Ortsteil" type="Ort_Stp" minOccurs="0"/>
          <xs:element name="LKZ" type="LKZ_Stp"/>
          <xs:element name="Postfach" type="Postfach_Stp" minOccurs="0"/>
        </xs:sequence>
      </xs:restriction>
    </xs:complexContent>
  </xs:complexType>
</xs:element>
<xs:element name="Kontakt" minOccurs="0">
  <xs:annotation>
    <xs:documentation>AAV12: Telefon, AAV16: Telefax, AAV15: Mobiltelefon,
AAV17: E-Mail-Adresse des anderen Adressaten</xs:documentation>
  </xs:annotation>
</xs:complexType>

```

```

<xs:complexContent>
  <xs:restriction base="Kontaktdaten_Ctp">
    <xs:sequence>
      <xs:element name="Telefon" type="Telefon_Stp" minOccurs="0"/>
      <xs:element name="Telefax" type="Telefax_Stp" minOccurs="0"/>
      <xs:element name="Mobiltelefon" type="Mobiltelefon_Stp"
mi nOccurs="0"/>
      <xs:element name="Email" type="Email_Stp" minOccurs="0"/>
    </xs:sequence>
  </xs:restriction>
</xs:complexContent>
</xs:complexType>
</xs:element>
<xs:element name="Besondere_Hinweise" minOccurs="0">
  <xs:annotation>
    <xs:documentation>AAV13: Besondere Hinweise</xs:documentation>
  </xs:annotation>
  <xs:simpleType>
    <xs:restriction base="Freitext_Mit_Zeilenumbrueche_Stp">
      <xs:minLength value="1"/>
    </xs:restriction>
  </xs:simpleType>
</xs:element>
</xs:sequence>
</xs:complexType>

```

element Adressat_Oder_Adresse_Ctp/Adressatsart

diagram																			
namespace	MD:/xml-schema/MD-basis/3.5																		
type	Anderer_Adressat_Stp																		
properties	content simple																		
facets	<table border="1"> <thead> <tr> <th>Kind</th> <th>Value</th> <th>Annotation</th> </tr> </thead> <tbody> <tr> <td>enumeration</td> <td>2</td> <td></td> </tr> <tr> <td>enumeration</td> <td>3</td> <td></td> </tr> <tr> <td>enumeration</td> <td>4</td> <td></td> </tr> <tr> <td>enumeration</td> <td>5</td> <td></td> </tr> <tr> <td>enumeration</td> <td>6</td> <td></td> </tr> </tbody> </table>	Kind	Value	Annotation	enumeration	2		enumeration	3		enumeration	4		enumeration	5		enumeration	6	
Kind	Value	Annotation																	
enumeration	2																		
enumeration	3																		
enumeration	4																		
enumeration	5																		
enumeration	6																		
annotation	documentation AAV01: (Schlüssel) Anderer Adressat als Versicherter																		
source	<xs:element name="Adressatsart" type="Anderer_Adressat_Stp"> <xs:annotation> <xs:documentation>AAV01: (Schlüssel) Anderer Adressat als Versicherter</xs:documentation> </xs:annotation> </xs:element>																		

element Adressat_Oder_Adresse_Ctp/Person

<p>diagram</p>	<p>AAV02: Name der Person bzw. Institution, AAV03: Vorname, AAV04: Titel, AAV05: Geschlecht, AAV14: Namenszusatz des anderen Adressaten, AAV18: Vorsatzwort</p>
<p>namespace</p>	<p>MD:/xml-schema/MD-basis/3.5</p>
<p>type</p>	<p>restriction of Person_Ctp</p>
<p>properties</p>	<p>content complex</p>
<p>children</p>	<p>Name Vorname Titel Geburtsdatum Geschlecht Namenszusatz Vorsatzwort Bes_schutz_Person Erl_bes_schutz_Person Genauigkeit_Geburtsdatum</p>
<p>annotation</p>	<p>documentation AAV02: Name der Person bzw. Institution, AAV03: Vorname, AAV04: Titel, AAV05: Geschlecht, AAV14: Namenszusatz des anderen Adressaten, AAV18: Vorsatzwort</p>
<p>source</p>	<pre><xs:element name="Person"> <xs:annotation> <xs:documentation>AAV02: Name der Person bzw. Institution, AAV03: Vorname, AAV04: Titel, AAV05: Geschlecht, AAV14: Namenszusatz des anderen Adressaten, AAV18: Vorsatzwort</xs:documentation> </xs:annotation> <xs:complexType> <xs:complexContent> <xs:restriction base="Person_Ctp"> <xs:sequence> <xs:element name="Name" type="Name_Stp"/> <xs:element name="Vorname" type="Name_Stp" minOccurs="0"/> <xs:element name="Titel" type="Titel_Stp" minOccurs="0"/> <xs:element name="Geburtsdatum" type="Datum_Stp" minOccurs="0" maxOccurs="0"/> <xs:element name="Geschlecht" type="Geschlecht_Stp" minOccurs="0"/> <xs:element name="Namenszusatz" type="Namenszusatz_Stp" minOccurs="0"/> <xs:element name="Vorsatzwort" type="Vorsatzwort_Stp" minOccurs="0"/> <xs:element name="Bes_schutz_Person" type="Bes_schutz_Person_Stp" minOccurs="0" maxOccurs="0"/> </xs:sequence> </xs:restriction> </xs:complexContent> </xs:complexType> </xs:element></pre>

	<pre> <xs:element name="Erl_bes_schutz_Person" type="Frei text_Mit_Zeilenenum_1000_Stp" minOccurs="0" maxOccurs="0"/> <xs:element name="Genauigkeitt_Geburtsdatum" type="Gen_Geburtsdatum_Stp" minOccurs="0" maxOccurs="0"/> </xs:sequence> </xs:restriction> </xs:complexContent> </xs:complexType> </xs:element> </pre>
--	---

element Adressat_Oder_Adresse_Ctp/Person/Name

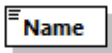
diagram													
namespace	MD:/xml-schema/MD-basis/3.5												
type	Name_Stp												
properties	content simple												
facets	<table border="1"> <thead> <tr> <th>Kind</th> <th>Value</th> <th>Annotation</th> </tr> </thead> <tbody> <tr> <td>minLength</td> <td>1</td> <td></td> </tr> <tr> <td>maxLength</td> <td>45</td> <td></td> </tr> <tr> <td>pattern</td> <td>\S*.[\p{L}].*</td> <td></td> </tr> </tbody> </table>	Kind	Value	Annotation	minLength	1		maxLength	45		pattern	\S*.[\p{L}].*	
Kind	Value	Annotation											
minLength	1												
maxLength	45												
pattern	\S*.[\p{L}].*												
source	<pre><xs:element name="Name" type="Name_Stp"/></pre>												

element Adressat_Oder_Adresse_Ctp/Person/Vorname

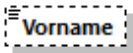
diagram													
namespace	MD:/xml-schema/MD-basis/3.5												
type	Name_Stp												
properties	<table border="1"> <tbody> <tr> <td>minOcc</td> <td>0</td> </tr> <tr> <td>maxOcc</td> <td>1</td> </tr> <tr> <td>content</td> <td>simple</td> </tr> </tbody> </table>	minOcc	0	maxOcc	1	content	simple						
minOcc	0												
maxOcc	1												
content	simple												
facets	<table border="1"> <thead> <tr> <th>Kind</th> <th>Value</th> <th>Annotation</th> </tr> </thead> <tbody> <tr> <td>minLength</td> <td>1</td> <td></td> </tr> <tr> <td>maxLength</td> <td>45</td> <td></td> </tr> <tr> <td>pattern</td> <td>\S*.[\p{L}].*</td> <td></td> </tr> </tbody> </table>	Kind	Value	Annotation	minLength	1		maxLength	45		pattern	\S*.[\p{L}].*	
Kind	Value	Annotation											
minLength	1												
maxLength	45												
pattern	\S*.[\p{L}].*												
source	<pre><xs:element name="Vorname" type="Name_Stp" minOccurs="0"/></pre>												

element Adressat_Oder_Adresse_Ctp/Person/Titel

diagram	
namespace	MD:/xml-schema/MD-basis/3.5
type	Titel_Stp

properties	minOcc 0 maxOcc 1 content simple
facets	Kind Value Annotation minLength 1 maxLength 20 pattern \S*.[\p{L}].*
source	<xs:element name="Titel" type="Titel_Stp" minOccurs="0"/>

element Adressat_Oder_Adresse_Ctp/Person/Geburtsdatum

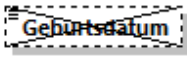
diagram	
namespace	MD:/xml-schema/MD-basis/3.5
type	Datum_Stp
properties	minOcc 0 maxOcc 0 content simple
facets	Kind Value Annotation minInclusive 1850-01-01 maxInclusive 2099-12-31
source	<xs:element name="Geburtsdatum" type="Datum_Stp" minOccurs="0" maxOccurs="0"/>

element Adressat_Oder_Adresse_Ctp/Person/Geschlecht

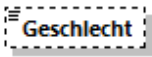
diagram	
namespace	MD:/xml-schema/MD-basis/3.5
type	Geschlecht_Stp
properties	minOcc 0 maxOcc 1 content simple
facets	Kind Value Annotation enumeration m enumeration w enumeration x enumeration d
source	<xs:element name="Geschlecht" type="Geschlecht_Stp" minOccurs="0"/>

element Adressat_Oder_Adresse_Ctp/Person/Namenszusatz

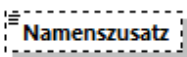
diagram	
namespace	MD:/xml-schema/MD-basis/3.5

type	Namenszusatz_Stp
properties	minOcc 0 maxOcc 1 content simple
facets	Kind Value Annotation minLength 1 maxLength 20 pattern \S*.[\p{L}].*
source	<xs:element name="Namenszusatz" type="Namenszusatz_Stp" minOccurs="0"/>

element Adressat_Oder_Adresse_Ctp/Person/Vorsatzwort

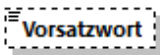
diagram	
namespace	MD/xml-schema/MD-basis/3.5
type	Vorsatzwort_Stp
properties	minOcc 0 maxOcc 1 content simple
facets	Kind Value Annotation minLength 1 maxLength 20 pattern \S*.[\p{L}].*
source	<xs:element name="Vorsatzwort" type="Vorsatzwort_Stp" minOccurs="0"/>

element Adressat_Oder_Adresse_Ctp/Person/Bes_schutz_Person

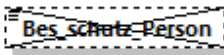
diagram	
namespace	MD/xml-schema/MD-basis/3.5
type	Bes_schutz_Person_Stp
properties	minOcc 0 maxOcc 0 content simple
facets	Kind Value Annotation enumeration 1 enumeration 2
source	<xs:element name="Bes_schutz_Person" type="Bes_schutz_Person_Stp" minOccurs="0" maxOccurs="0"/>

element Adressat_Oder_Adresse_Ctp/Person/Erl_bes_schutz_Person

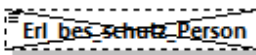
diagram	
---------	---

namespace	MD:/xml-schema/MD-basis/3.5
type	Freitext Mit Zeilenum 1000 Stp
properties	minOcc 0 maxOcc 0 content simple
facets	Kind Value Annotation maxLength 1000 pattern \S+[\n\r\t -ÿ]*
source	<xs:element name="ErI_bes_schutz_Person" type="Frei text_Mi t_Zei lenum_1000_Stp" minOccurs="0" maxOccurs="0"/>

element Adressat_Oder_Adresse_Ctp/Person/Genauigkeit_Geburtsdatum

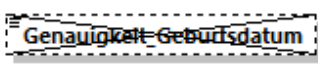
diagram	
namespace	MD:/xml-schema/MD-basis/3.5
type	Gen_Geburtsdatum Stp
properties	minOcc 0 maxOcc 0 content simple
facets	Kind Value Annotation enumeration 1 enumeration 2
source	<xs:element name="Genauigkeit_Geburtsdatum" type="Gen_Geburtsdatum_Stp" minOccurs="0" maxOccurs="0"/>

element Adressat_Oder_Adresse_Ctp/Adresse

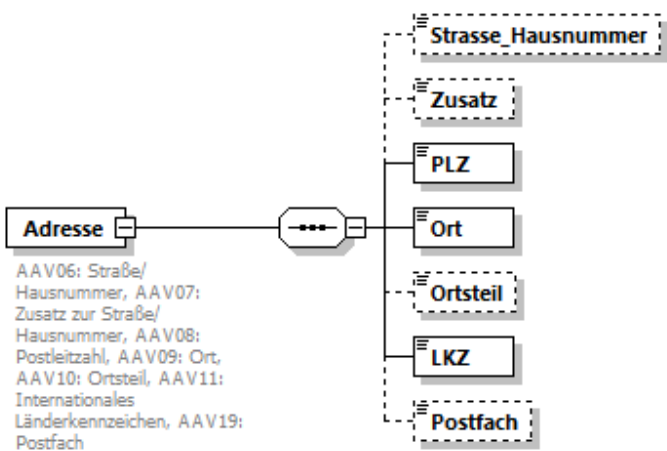
diagram	
namespace	MD:/xml-schema/MD-basis/3.5
type	restriction of Adresse_Ctp
properties	content complex

children	Strasse_Hausnummer Zusatz PLZ Ort Ortsteil LKZ Postfach
annotation	documentation AAV06: Straße/ Hausnummer, AAV07: Zusatz zur Straße/ Hausnummer, AAV08: Postleitzahl, AAV09: Ort, AAV10: Ortsteil, AAV11: Internationales Länderkennzeichen, AAV19: Postfach
source	<pre> <xs:element name="Adresse"> <xs:annotation> <xs:documentation>AAV06: Straße/ Hausnummer, AAV07: Zusatz zur Straße/ Hausnummer, AAV08: Postleitzahl, AAV09: Ort, AAV10: Ortsteil, AAV11: Internationales Länderkennzeichen, AAV19: Postfach</xs:documentation> </xs:annotation> <xs:complexType> <xs:complexContent> <xs:restriction base="Adresse_Ctp"> <xs:sequence> <xs:element name="Strasse_Hausnummer" type="Strasse_Hausnummer_Stp" minOccurs="0"/> <xs:element name="Zusatz" type="Anschriftenzusatz_Stp" minOccurs="0"/> <xs:element name="PLZ" type="PLZ_Stp"/> <xs:element name="Ort" type="Ort_Stp"/> <xs:element name="Ortsteil" type="Ort_Stp" minOccurs="0"/> <xs:element name="LKZ" type="LKZ_Stp"/> <xs:element name="Postfach" type="Postfach_Stp" minOccurs="0"/> </xs:sequence> </xs:restriction> </xs:complexContent> </xs:complexType> </xs:element> </pre>

element Adressat_Oder_Adresse_Ctp/Adresse/Strasse_Hausnummer

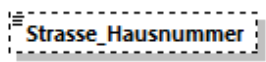
diagram													
namespace	MD/xml-schema/MD-basis/3.5												
type	Strasse_Hausnummer_Stp												
properties	minOcc 0 maxOcc 1 content simple												
facets	<table border="1"> <thead> <tr> <th>Kind</th> <th>Value</th> <th>Annotation</th> </tr> </thead> <tbody> <tr> <td>minLength</td> <td>1</td> <td></td> </tr> <tr> <td>maxLength</td> <td>56</td> <td></td> </tr> <tr> <td>pattern</td> <td>\S*.*[\p{L}].*</td> <td></td> </tr> </tbody> </table>	Kind	Value	Annotation	minLength	1		maxLength	56		pattern	\S*.*[\p{L}].*	
Kind	Value	Annotation											
minLength	1												
maxLength	56												
pattern	\S*.*[\p{L}].*												
source	<pre> <xs:element name="Strasse_Hausnummer" type="Strasse_Hausnummer_Stp" minOccurs="0"/> </pre>												

element Adressat_Oder_Adresse_Ctp/Adresse/Zusatz

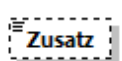
diagram	
---------	---

namespace	MD:/xml-schema/MD-basis/3.5												
type	Anschriftenzusatz_Stp												
properties	minOcc 0 maxOcc 1 content simple												
facets	<table border="1"> <thead> <tr> <th>Kind</th> <th>Value</th> <th>Annotation</th> </tr> </thead> <tbody> <tr> <td>minLength</td> <td>1</td> <td></td> </tr> <tr> <td>maxLength</td> <td>40</td> <td></td> </tr> <tr> <td>pattern</td> <td colspan="2">\S*.*[\p{L}\p{N}].*</td> </tr> </tbody> </table>	Kind	Value	Annotation	minLength	1		maxLength	40		pattern	\S*.*[\p{L}\p{N}].*	
Kind	Value	Annotation											
minLength	1												
maxLength	40												
pattern	\S*.*[\p{L}\p{N}].*												
source	<xs:element name="Zusatz" type="Anschriftenzusatz_Stp" minOccurs="0"/>												

element Adressat_Oder_Adresse_Ctp/Adresse/PLZ

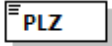
diagram													
namespace	MD:/xml-schema/MD-basis/3.5												
type	PLZ_Stp												
properties	content simple												
facets	<table border="1"> <thead> <tr> <th>Kind</th> <th>Value</th> <th>Annotation</th> </tr> </thead> <tbody> <tr> <td>minLength</td> <td>1</td> <td></td> </tr> <tr> <td>maxLength</td> <td>10</td> <td></td> </tr> <tr> <td>pattern</td> <td colspan="2">\S*.*[\p{L}\p{N}]+.*</td> </tr> </tbody> </table>	Kind	Value	Annotation	minLength	1		maxLength	10		pattern	\S*.*[\p{L}\p{N}]+.*	
Kind	Value	Annotation											
minLength	1												
maxLength	10												
pattern	\S*.*[\p{L}\p{N}]+.*												
source	<xs:element name="PLZ" type="PLZ_Stp"/>												

element Adressat_Oder_Adresse_Ctp/Adresse/Ort

diagram													
namespace	MD:/xml-schema/MD-basis/3.5												
type	Ort_Stp												
properties	content simple												
facets	<table border="1"> <thead> <tr> <th>Kind</th> <th>Value</th> <th>Annotation</th> </tr> </thead> <tbody> <tr> <td>minLength</td> <td>1</td> <td></td> </tr> <tr> <td>maxLength</td> <td>40</td> <td></td> </tr> <tr> <td>pattern</td> <td colspan="2">\S*.*[\p{L}].*</td> </tr> </tbody> </table>	Kind	Value	Annotation	minLength	1		maxLength	40		pattern	\S*.*[\p{L}].*	
Kind	Value	Annotation											
minLength	1												
maxLength	40												
pattern	\S*.*[\p{L}].*												
source	<xs:element name="Ort" type="Ort_Stp"/>												

element Adressat_Oder_Adresse_Ctp/Adresse/Ortsteil

diagram	
---------	---

namespace	MD:/xml-schema/MD-basis/3.5
type	Ort_Stp
properties	minOcc 0 maxOcc 1 content simple
facets	Kind Value Annotation minLength 1 maxLength 40 pattern \S*.[\p{L}].*
source	<xs:element name="Ortsteil" type="Ort_Stp" minOccurs="0"/>

element Adressat_Oder_Adresse_Ctp/Adresse/LKZ

diagram	
namespace	MD:/xml-schema/MD-basis/3.5
type	LKZ_Stp
properties	content simple
facets	Kind Value Annotation minLength 1 maxLength 3 pattern [A-Z]+
source	<xs:element name="LKZ" type="LKZ_Stp"/>

element Adressat_Oder_Adresse_Ctp/Adresse/Postfach

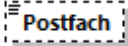
diagram	
namespace	MD:/xml-schema/MD-basis/3.5
type	Postfach_Stp
properties	minOcc 0 maxOcc 1 content simple
facets	Kind Value Annotation minLength 1 maxLength 45 pattern \S+ [-ÿ]*
source	<xs:element name="Postfach" type="Postfach_Stp" minOccurs="0"/>

element Adressat_Oder_Adresse_Ctp/Kontakt

diagram	<p>AAV12: Telefon, AAV16: Telefax, AAV15: Mobiltelefon, AAV17: E-Mail-Adresse des anderen Adressaten</p>
namespace	MD:/xml-schema/MD-basis/3.5
type	restriction of Kontaktdaten_Ctp
properties	minOcc 0 maxOcc 1 content complex
children	Telefon Telefax Mobiltelefon Email
annotation	documentation AAV12: Telefon, AAV16: Telefax, AAV15: Mobiltelefon, AAV17: E-Mail-Adresse des anderen Adressaten
source	<pre><xs:element name="Kontakt" minOccurs="0"> <xs:annotation> <xs:documentation>AAV12: Telefon, AAV16: Telefax, AAV15: Mobiltelefon, AAV17: E-Mail-Adresse des anderen Adressaten</xs:documentation> </xs:annotation> <xs:complexType> <xs:complexContent> <xs:restriction base="Kontaktdaten_Ctp"> <xs:sequence> <xs:element name="Telefon" type="Telefon_Stp" minOccurs="0"/> <xs:element name="Telefax" type="Telefax_Stp" minOccurs="0"/> <xs:element name="Mobiltelefon" type="Mobiltelefon_Stp" minOccurs="0"/> <xs:element name="Email" type="Email_Stp" minOccurs="0"/> </xs:sequence> </xs:restriction> </xs:complexContent> </xs:complexType> </xs:element></pre>

element Adressat_Oder_Adresse_Ctp/Kontakt/Telefon

diagram										
namespace	MD:/xml-schema/MD-basis/3.5									
type	Telefon_Stp									
properties	minOcc 0 maxOcc 1 content simple									
facets	<table border="0"> <tr> <td>Kind</td> <td>Value</td> <td>Annotation</td> </tr> <tr> <td>minLength</td> <td>1</td> <td></td> </tr> <tr> <td>maxLength</td> <td>20</td> <td></td> </tr> </table>	Kind	Value	Annotation	minLength	1		maxLength	20	
Kind	Value	Annotation								
minLength	1									
maxLength	20									

	pattern \S*.[\p{L}\p{N}].*
source	<xs:element name="Telefon" type="Telefon_Stp" minOccurs="0"/>

element Adressat_Oder_Adresse_Ctp/Kontakt/Telefax

diagram	
namespace	MD/xml-schema/MD-basis/3.5
type	Telefax_Stp
properties	minOcc 0 maxOcc 1 content simple
facets	Kind Value Annotation minLength 1 maxLength 20 pattern \S*.[\p{L}\p{N}].*
source	<xs:element name="Telefax" type="Telefax_Stp" minOccurs="0"/>

element Adressat_Oder_Adresse_Ctp/Kontakt/Mobiltelefon

diagram	
namespace	MD/xml-schema/MD-basis/3.5
type	Mobiltelefon_Stp
properties	minOcc 0 maxOcc 1 content simple
facets	Kind Value Annotation minLength 1 maxLength 20 pattern \S*.[\p{L}\p{N}].*
source	<xs:element name="Mobiltelefon" type="Mobiltelefon_Stp" minOccurs="0"/>

element Adressat_Oder_Adresse_Ctp/Kontakt/Email

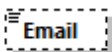
diagram	
namespace	MD/xml-schema/MD-basis/3.5
type	Email_Stp
properties	minOcc 0 maxOcc 1 content simple
facets	Kind Value Annotation minLength 1

	maxLength 50 pattern [\-a-zA-Z0-9\\.\\+]+@[a-zA-Z0-9](\\.[\-a-zA-Z0-9]*[a-zA-Z0-9]) [*]
source	<xs:element name="Email" type="Email_Stp" minOccurs="0"/>

element Adressat_Oder_Adresse_Ctp/Besondere_Hinweise

diagram													
namespace	MD:/xml-schema/MD-basis/3.5												
type	restriction of Freitext_Mit_Zeilenumbrueche_Stp												
properties	minOcc 0 maxOcc 1 content simple												
facets	<table border="1"> <thead> <tr> <th>Kind</th> <th>Value</th> <th>Annotation</th> </tr> </thead> <tbody> <tr> <td>minLength</td> <td>1</td> <td></td> </tr> <tr> <td>maxLength</td> <td>255</td> <td></td> </tr> <tr> <td>pattern</td> <td>\\S+[\n\r\t&#x0020;-&#x00FF;][*]</td> <td></td> </tr> </tbody> </table>	Kind	Value	Annotation	minLength	1		maxLength	255		pattern	\\S+[\n\r\t -ÿ] [*]	
Kind	Value	Annotation											
minLength	1												
maxLength	255												
pattern	\\S+[\n\r\t -ÿ] [*]												
annotation	documentation AAV13: Besondere Hinweise												
source	<pre> <xs:element name="Besondere_Hinweise" minOccurs="0"> <xs:annotation> <xs:documentation>AAV13: Besondere Hinweise</xs:documentation> </xs:annotation> <xs:simpleType> <xs:restriction base="Freitext_Mit_Zeilenumbrueche_Stp"> <xs:minLength value="1"/> </xs:restriction> </xs:simpleType> </xs:element> </pre>												

complexType Adresse_Ctp

diagram	
---------	--

namespace	MD:/xml-schema/MD-basis/3.5
children	Strasse_Hausnummer Zusatz PLZ Ort Ortsteil LKZ Postfach
used by	elements Adressat Oder Adresse Ctp/Adresse Arzt Ctp/Adresse Kasse Ctp/Adresse Leistungserbringer Ctp/Adresse MD Ctp/Adresse Versicherter Ctp/Adresse
annotation	documentation Adressdaten
source	<pre> <xs:complexType name="Adresse_Ctp"> <xs:annotation> <xs:documentation>Adressdaten</xs:documentation> </xs:annotation> <xs:sequence> <xs:element name="Strasse_Hausnummer" type="Strasse_Hausnummer_Stp" minOccurs="0"/> <xs:element name="Zusatz" type="Anschri ftenzusatz_Stp" minOccurs="0"/> <xs:element name="PLZ" type="PLZ_Stp" minOccurs="0"/> <xs:element name="Ort" type="Ort_Stp" minOccurs="0"/> <xs:element name="Ortstei l" type="Ort_Stp" minOccurs="0"/> <xs:element name="LKZ" type="LKZ_Stp" minOccurs="0"/> <xs:element name="Postfach" type="Postfach_Stp" minOccurs="0"/> </xs:sequence> </xs:complexType> </pre>

element Adresse_Ctp/Strasse_Hausnummer

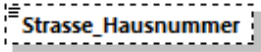
diagram													
namespace	MD:/xml-schema/MD-basis/3.5												
type	Strasse_Hausnummer_Stp												
properties	minOcc 0 maxOcc 1 content simple												
facets	<table border="1"> <thead> <tr> <th>Kind</th> <th>Value</th> <th>Annotation</th> </tr> </thead> <tbody> <tr> <td>minLength</td> <td>1</td> <td></td> </tr> <tr> <td>maxLength</td> <td>56</td> <td></td> </tr> <tr> <td>pattern</td> <td>\S*.[\p{L}].*</td> <td></td> </tr> </tbody> </table>	Kind	Value	Annotation	minLength	1		maxLength	56		pattern	\S*.[\p{L}].*	
Kind	Value	Annotation											
minLength	1												
maxLength	56												
pattern	\S*.[\p{L}].*												
source	<pre> <xs:element name="Strasse_Hausnummer" type="Strasse_Hausnummer_Stp" minOccurs="0"/> </pre>												

element Adresse_Ctp/Zusatz

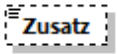
diagram	
namespace	MD:/xml-schema/MD-basis/3.5
type	Anschri ftenzusatz_Stp
properties	minOcc 0 maxOcc 1 content simple

facets	Kind	Value	Annotation
	minLength	1	
	maxLength	40	
	pattern	\S*.[\p{L}\p{N}].*	
source	<xs:element name="Zusatz" type="Anschri ftenzusatz_Stp" mi n0ccurs="0"/>		

element Adresse_Ctp/PLZ

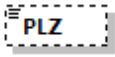
diagram			
namespace	MD:/xml-schema/MD-basis/3.5		
type	PLZ_Stp		
properties	minOcc	0	
	maxOcc	1	
	content	simple	
facets	Kind	Value	Annotation
	minLength	1	
	maxLength	10	
	pattern	\S*.[\p{L}\p{N}+].*	
source	<xs:element name="PLZ" type="PLZ_Stp" mi n0ccurs="0"/>		

element Adresse_Ctp/Ort

diagram			
namespace	MD:/xml-schema/MD-basis/3.5		
type	Ort_Stp		
properties	minOcc	0	
	maxOcc	1	
	content	simple	
facets	Kind	Value	Annotation
	minLength	1	
	maxLength	40	
	pattern	\S*.[\p{L}].*	
source	<xs:element name="Ort" type="Ort_Stp" mi n0ccurs="0"/>		

element Adresse_Ctp/Ortsteil

diagram			
namespace	MD:/xml-schema/MD-basis/3.5		
type	Ort_Stp		
properties	minOcc	0	
	maxOcc	1	

	content simple												
facets	<table border="1"> <thead> <tr> <th>Kind</th> <th>Value</th> <th>Annotation</th> </tr> </thead> <tbody> <tr> <td>minLength</td> <td>1</td> <td></td> </tr> <tr> <td>maxLength</td> <td>40</td> <td></td> </tr> <tr> <td>pattern</td> <td>\S*.[\p{L}].*</td> <td></td> </tr> </tbody> </table>	Kind	Value	Annotation	minLength	1		maxLength	40		pattern	\S*.[\p{L}].*	
Kind	Value	Annotation											
minLength	1												
maxLength	40												
pattern	\S*.[\p{L}].*												
source	<xs:element name="Ortsteil" type="Ort_Stp" minOccurs="0"/>												

element Adresse_Ctp/LKZ

diagram													
namespace	MD:/xml-schema/MD-basis/3.5												
type	LKZ_Stp												
properties	<table border="1"> <tbody> <tr> <td>minOcc</td> <td>0</td> </tr> <tr> <td>maxOcc</td> <td>1</td> </tr> <tr> <td>content</td> <td>simple</td> </tr> </tbody> </table>	minOcc	0	maxOcc	1	content	simple						
minOcc	0												
maxOcc	1												
content	simple												
facets	<table border="1"> <thead> <tr> <th>Kind</th> <th>Value</th> <th>Annotation</th> </tr> </thead> <tbody> <tr> <td>minLength</td> <td>1</td> <td></td> </tr> <tr> <td>maxLength</td> <td>3</td> <td></td> </tr> <tr> <td>pattern</td> <td>[A-Z]+</td> <td></td> </tr> </tbody> </table>	Kind	Value	Annotation	minLength	1		maxLength	3		pattern	[A-Z]+	
Kind	Value	Annotation											
minLength	1												
maxLength	3												
pattern	[A-Z]+												
source	<xs:element name="LKZ" type="LKZ_Stp" minOccurs="0"/>												

element Adresse_Ctp/Postfach

diagram													
namespace	MD:/xml-schema/MD-basis/3.5												
type	Postfach_Stp												
properties	<table border="1"> <tbody> <tr> <td>minOcc</td> <td>0</td> </tr> <tr> <td>maxOcc</td> <td>1</td> </tr> <tr> <td>content</td> <td>simple</td> </tr> </tbody> </table>	minOcc	0	maxOcc	1	content	simple						
minOcc	0												
maxOcc	1												
content	simple												
facets	<table border="1"> <thead> <tr> <th>Kind</th> <th>Value</th> <th>Annotation</th> </tr> </thead> <tbody> <tr> <td>minLength</td> <td>1</td> <td></td> </tr> <tr> <td>maxLength</td> <td>45</td> <td></td> </tr> <tr> <td>pattern</td> <td>\S+ [&#x0020;-&#x00FF;]*</td> <td></td> </tr> </tbody> </table>	Kind	Value	Annotation	minLength	1		maxLength	45		pattern	\S+ [-ÿ]*	
Kind	Value	Annotation											
minLength	1												
maxLength	45												
pattern	\S+ [-ÿ]*												
source	<xs:element name="Postfach" type="Postfach_Stp" minOccurs="0"/>												

complexType Aktenzeichen_anderer_Begutachtungsfall_Ctp

diagram	
namespace	MD:/xml-schema/MD-basis/3.5
children	Aktenzeichen Fallnummer
used by	elements Beauftragung/Auftrag/Infos/Aktenzeichen_anderer_Begutachtungsfall Begutachtung/Stellungnahme/Pruefung/Aktenzeichen_anderer_Begutachtungsfall
annotation	documentation Aktenzeichen anderer Begutachtungsfall
source	<pre><xs:complexType name="Aktenzeichen_anderer_Begutachtungsfall_Ctp"> <xs:annotation> <xs:documentation>Aktenzeichen anderer Begutachtungsfall </xs:documentation> </xs:annotation> <xs:sequence> <xs:element name="Aktenzeichen" type="Aktenzeichen_Stp"> <xs:annotation> <xs:documentation>AAB01: Aktenzeichen der Kranken-/Pflegekasse</xs:documentation> </xs:annotation> </xs:element> <xs:element name="Fallnummer" type="Fallnummer_Stp" minOccurs="0"> <xs:annotation> <xs:documentation>AAB02: Fall-ID Krankenhaus (AKH02, Aufnahme-Nr.)</xs:documentation> </xs:annotation> </xs:element> </xs:sequence> </xs:complexType></pre>

element Aktenzeichen_anderer_Begutachtungsfall_Ctp/Aktenzeichen

diagram													
namespace	MD:/xml-schema/MD-basis/3.5												
type	Aktenzeichen_Stp												
properties	content simple												
facets	<table border="1"> <thead> <tr> <th>Kind</th> <th>Value</th> <th>Annotation</th> </tr> </thead> <tbody> <tr> <td>minLength</td> <td>2</td> <td></td> </tr> <tr> <td>maxLength</td> <td>18</td> <td></td> </tr> <tr> <td>pattern</td> <td>\S+ [&#x0020; - &#x00FF;]*</td> <td></td> </tr> </tbody> </table>	Kind	Value	Annotation	minLength	2		maxLength	18		pattern	\S+ [- ÿ]*	
Kind	Value	Annotation											
minLength	2												
maxLength	18												
pattern	\S+ [- ÿ]*												

annotation	documentation AAB01: Aktenzeichen der Kranken-/Pflegekasse
source	<xs:element name="Aktenzeichen" type="Aktenzeichen_Stp"> <xs:annotation> <xs:documentation>AAB01: Aktenzeichen der Kranken-/Pflegekasse</xs:documentation> </xs:annotation> </xs:element>

element Aktenzeichen_anderer_Begutachtungsfall_Ctp/Fallnummer

diagram	
namespace	MD:/xml-schema/MD-basis/3.5
type	Fallnummer_Stp
properties	minOcc 0 maxOcc 1 content simple
facets	Kind Value Annotation minLength 1 maxLength 50 pattern \S+[\ -ÿ]*
annotation	documentation AAB02: Fall-ID Krankenhaus (AKH02, Aufnahme-Nr.)
source	<xs:element name="Fallnummer" type="Fallnummer_Stp" minOccurs="0"> <xs:annotation> <xs:documentation>AAB02: Fall-ID Krankenhaus (AKH02, Aufnahme-Nr.)</xs:documentation> </xs:annotation> </xs:element>

complexType Aktenzeichen_Ctp

diagram	
namespace	MD:/xml-schema/MD-basis/3.5

children	Aktenzeichen Aktenzeichen_1Folge Aktenzeichen_2Folge
used by	element Kasse_Ctp/Aktenzeichen
annotation	documentation Aktenzeichen
source	<pre> <xs:complexType name="Aktenzeichen_Ctp"> <xs:annotation> <xs:documentation>Aktenzeichen</xs:documentation> </xs:annotation> <xs:sequence> <xs:element name="Aktenzeichen" type="Aktenzeichen_Stp"> <xs:annotation> <xs:documentation>ASK08: Aktenzeichen der Kranken-/Pflegekasse</xs:documentation> </xs:annotation> </xs:element> <xs:element name="Aktenzeichen_1Folge" type="Aktenzeichen_Stp" minOccurs="0"> <xs:annotation> <xs:documentation>ASK19: Aktenzeichen der Erstbeauftragung bei Folgeauftrag</xs:documentation> </xs:annotation> </xs:element> <xs:element name="Aktenzeichen_2Folge" type="Aktenzeichen_Stp" minOccurs="0"> <xs:annotation> <xs:documentation>ASK20: Aktenzeichen des ersten Folgeauftrages bei zweitem Folgeauftrag</xs:documentation> </xs:annotation> </xs:element> </xs:sequence> </xs:complexType> </pre>

element Aktenzeichen_Ctp/Aktenzeichen

diagram													
namespace	MD/xml-schema/MD-basis/3.5												
type	Aktenzeichen_Stp												
properties	content simple												
facets	<table border="1"> <thead> <tr> <th>Kind</th> <th>Value</th> <th>Annotation</th> </tr> </thead> <tbody> <tr> <td>minLength</td> <td>2</td> <td></td> </tr> <tr> <td>maxLength</td> <td>18</td> <td></td> </tr> <tr> <td>pattern</td> <td>\S+ [&#x0020;-&#x00FF;]*</td> <td></td> </tr> </tbody> </table>	Kind	Value	Annotation	minLength	2		maxLength	18		pattern	\S+ [-ÿ]*	
Kind	Value	Annotation											
minLength	2												
maxLength	18												
pattern	\S+ [-ÿ]*												
annotation	documentation ASK08: Aktenzeichen der Kranken-/Pflegekasse												
source	<pre> <xs:element name="Aktenzeichen" type="Aktenzeichen_Stp"> <xs:annotation> <xs:documentation>ASK08: Aktenzeichen der Kranken-/Pflegekasse</xs:documentation> </xs:annotation> </xs:element> </pre>												

	<pre></xs: annotation> </xs: element></pre>
--	---

element Aktenzeichen_Ctp/Aktenzeichen_1Folge

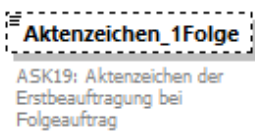
diagram													
namespace	MD:/xml-schema/MD-basis/3.5												
type	Aktenzeichen_Stp												
properties	minOcc 0 maxOcc 1 content simple												
facets	<table border="0"> <tr> <td>Kind</td> <td>Value</td> <td>Annotation</td> </tr> <tr> <td>minLength</td> <td>2</td> <td></td> </tr> <tr> <td>maxLength</td> <td>18</td> <td></td> </tr> <tr> <td>pattern</td> <td colspan="2">\S+ [&#x0020;-&#x00FF;]*</td> </tr> </table>	Kind	Value	Annotation	minLength	2		maxLength	18		pattern	\S+ [-ÿ]*	
Kind	Value	Annotation											
minLength	2												
maxLength	18												
pattern	\S+ [-ÿ]*												
annotation	documentation ASK19: Aktenzeichen der Erstbeauftragung bei Folgeauftrag												
source	<pre><xs: element name="Aktenzeichen_1Folge" type="Aktenzeichen_Stp" minOccurs="0"> <xs: annotation> <xs: documentation>ASK19: Aktenzeichen der Erstbeauftragung bei Folgeauftrag</xs: documentation> </xs: annotation> </xs: element></pre>												

element Aktenzeichen_Ctp/Aktenzeichen_2Folge

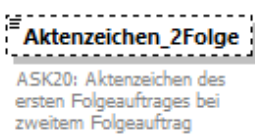
diagram													
namespace	MD:/xml-schema/MD-basis/3.5												
type	Aktenzeichen_Stp												
properties	minOcc 0 maxOcc 1 content simple												
facets	<table border="0"> <tr> <td>Kind</td> <td>Value</td> <td>Annotation</td> </tr> <tr> <td>minLength</td> <td>2</td> <td></td> </tr> <tr> <td>maxLength</td> <td>18</td> <td></td> </tr> <tr> <td>pattern</td> <td colspan="2">\S+ [&#x0020;-&#x00FF;]*</td> </tr> </table>	Kind	Value	Annotation	minLength	2		maxLength	18		pattern	\S+ [-ÿ]*	
Kind	Value	Annotation											
minLength	2												
maxLength	18												
pattern	\S+ [-ÿ]*												
annotation	documentation ASK20: Aktenzeichen des ersten Folgeauftrages bei zweitem Folgeauftrag												
source	<pre><xs: element name="Aktenzeichen_2Folge" type="Aktenzeichen_Stp" minOccurs="0"> <xs: annotation> <xs: documentation>ASK20: Aktenzeichen des ersten Folgeauftrages bei zwei tem </pre>												

```

Folgeauftrag</xs:documentation>
</xs:annotation>
</xs:element>

```

complexType Arzt_Ctp

<p>diagram</p>	<p>Identifikationsmerkmal +</p> <p>LANR oder BSNR oder IK oder Zahnarzt Nummer und KZV-Bereich des Zahnarztes</p> <p>Person +</p> <p>BHA04: Name Arzt/Verordner, BHA05: Vorname Arzt, BHA06: Titel, BHA07: Geschlecht, BHA18: Namenszusatz Arzt, BHA19: Vorsatzwort</p> <p>Adresse +</p> <p>BHA08: Straße/Hausnummer, BHA09: Zusatz zur Straße/Hausnummer, BHA10: Postleitzahl, BHA11: Ort, BHA12: Ortsteil, BHA13: Internationales Länderkennzeichen</p> <p>Kontakt +</p> <p>BHA14: Telefon, BHA15: Telefax</p> <p>Facharztbezeichnung</p> <p>BHA16: Facharztbezeichnung</p> <p>Abw_Bez_Anschrift</p> <p>BHA17: ggfs. abweichende Bezeichnung in der Anschrift</p>
<p>namespace</p>	<p>MD:/xml-schema/MD-basis/3.5</p>
<p>children</p>	<p>Identifikationsmerkmal Person Adresse Kontakt Facharztbezeichnung Abw_Bez_Anschrift</p>
<p>annotation</p>	<p>documentation BHA: Stammdaten behandelnder Arzt / Verordner</p>
<p>source</p>	<pre> <xs:complexType name="Arzt_Ctp"> <xs:annotation> <xs:documentation>BHA: Stammdaten behandelnder Arzt / Verordner</xs:documentation> </xs:annotation> <xs:sequence> <xs:element name="Identifikationsmerkmal" type="Identifikationsmerkmal_Ctp"> <xs:annotation> <xs:documentation>LANR oder BSNR oder IK oder Zahnarzt Nummer und KZV-Bereich des Zahnarztes</xs:documentation> </xs:annotation> </pre>

```

</xs:element>
<xs:element name="Person">
  <xs:annotation>
    <xs:documentation>BHA04: Name Arzt/Verordner, BHA05: Vorname Arzt, BHA06:
Titel, BHA07: Geschlecht, BHA18: Namenszusatz Arzt, BHA19:
Vorsatzwort</xs:documentation>
  </xs:annotation>
  <xs:complexType>
    <xs:complexContent>
      <xs:restriction base="Person_Ctp">
        <xs:sequence>
          <xs:element name="Name" type="Name_Stp"/>
          <xs:element name="Vorname" type="Name_Stp" minOccurs="0"/>
          <xs:element name="Titel" type="Titel_Stp" minOccurs="0"/>
          <xs:element name="Geburtsdatum" type="Datum_Stp" minOccurs="0"
maxOccurs="0"/>
          <xs:element name="Geschlecht" type="Geschlecht_Stp" minOccurs="0"/>
          <xs:element name="Namenszusatz" type="Namenszusatz_Stp"
minOccurs="0"/>
          <xs:element name="Vorsatzwort" type="Vorsatzwort_Stp"
minOccurs="0"/>
          <xs:element name="Bes_schutz_Person" type="Bes_schutz_Person_Stp"
minOccurs="0" maxOccurs="0"/>
          <xs:element name="Erl_bes_schutz_Person"
type="Frei_text_Mit_Zeilenenum_1000_Stp" minOccurs="0" maxOccurs="0"/>
          <xs:element name="Genauigkeit_Geburtsdatum"
type="Gen_Geburtsdatum_Stp" minOccurs="0" maxOccurs="0"/>
        </xs:sequence>
      </xs:restriction>
    </xs:complexContent>
  </xs:complexType>
</xs:element>
<xs:element name="Adresse">
  <xs:annotation>
    <xs:documentation>BHA08: Straße/ Hausnummer, BHA09: Zusatz zur Straße/
Hausnummer, BHA10: Postleitzahl, BHA11: Ort, BHA12: Ortsteil, BHA13: Internationales
Länderkennzeichen</xs:documentation>
  </xs:annotation>
  <xs:complexType>
    <xs:complexContent>
      <xs:restriction base="Adresse_Ctp">
        <xs:sequence>
          <xs:element name="Strasse_Hausnummer" type="Strasse_Hausnummer_Stp"
minOccurs="0"/>
          <xs:element name="Zusatz" type="Anschri ftenzusatz_Stp"
minOccurs="0"/>
          <xs:element name="PLZ" type="PLZ_Stp"/>
          <xs:element name="Ort" type="Ort_Stp"/>
          <xs:element name="Ortsteil" type="Ort_Stp" minOccurs="0"/>
          <xs:element name="LKZ" type="LKZ_Stp" minOccurs="0"/>
          <xs:element name="Postfach" type="Postfach_Stp" minOccurs="0"
maxOccurs="0"/>
        </xs:sequence>
      </xs:restriction>
    </xs:complexContent>
  </xs:complexType>

```

```

</xs:complexType>
</xs:element>
<xs:element name="Kontakt" minOccurs="0">
  <xs:annotation>
    <xs:documentation>BHA14: Telefon, BHA15: Telefax</xs:documentation>
  </xs:annotation>
  <xs:complexType>
    <xs:complexContent>
      <xs:restriction base="Kontaktdaten_Ctp">
        <xs:sequence>
          <xs:element name="Telefon" type="Telefon_Stp" minOccurs="0"/>
          <xs:element name="Telefax" type="Telefax_Stp" minOccurs="0"/>
          <xs:element name="Mobiltelefon" type="Mobiltelefon_Stp"
minOccurs="0" maxOccurs="0"/>
          <xs:element name="Email" type="Email_Stp" minOccurs="0"
maxOccurs="0"/>
        </xs:sequence>
      </xs:restriction>
    </xs:complexContent>
  </xs:complexType>
  </xs:element>
  <xs:element name="Facharztbezeichnung" type="Facharztbezeichnung_Stp"
minOccurs="0">
    <xs:annotation>
      <xs:documentation>BHA16: Facharztbezeichnung</xs:documentation>
    </xs:annotation>
  </xs:element>
  <xs:element name="Abw_Bez_Anschrift" type="Abw_Anschrift_Stp" minOccurs="0">
    <xs:annotation>
      <xs:documentation>BHA17: ggfs. abweichende Bezeichnung in der
Anschrift</xs:documentation>
    </xs:annotation>
  </xs:element>
</xs:sequence>
</xs:complexType>

```

element Arzt_Ctp/Identifikationsmerkmal

<p>diagram</p>	
<p>namespace</p>	<p>MD:/xml-schema/MD-basis/3.5</p>
<p>type</p>	<p>Identifikationsmerkmal_Ctp</p>
<p>properties</p>	<p>content complex</p>
<p>children</p>	<p>LANR BSNR IK Zahnarzt Nummer KZV_Bereich</p>
<p>annotation</p>	<p>documentation LANR oder BSNR oder IK oder Zahnarzt Nummer und KZV-Bereich des Zahnarztes</p>
<p>source</p>	<pre><xs:element name="Identifikationsmerkmal" type="Identifikationsmerkmal_Ctp"> <xs:annotation> <xs:documentation>LANR oder BSNR oder IK oder Zahnarzt Nummer und KZV-Bereich des Zahnarztes</xs:documentation> </xs:annotation> </xs:element></pre>

element Arzt_Ctp/Person

<p>diagram</p>	
<p>namespace</p>	<p>MD:/xml-schema/MD-basis/3.5</p>
<p>type</p>	<p>restriction of Person_Ctp</p>
<p>properties</p>	<p>content complex</p>
<p>children</p>	<p>Name Vorname Titel Geburtsdatum Geschlecht Namenszusatz Vorsatzwort Bes_schutz_Person Erl_bes_schutz_Person Genauigkeit_Geburtsdatum</p>
<p>annotation</p>	<p>documentation BHA04:Name Arzt/Verordner, BHA05: Vorname Arzt, BHA06: Titel, BHA07: Geschlecht, BHA18: Namenszusatz Arzt, BHA19: Vorsatzwort</p>
<p>source</p>	<pre><xs:element name="Person"> <xs:annotation> <xs:documentation>BHA04:Name Arzt/Verordner, BHA05: Vorname Arzt, BHA06: Titel, BHA07: Geschlecht, BHA18: Namenszusatz Arzt, BHA19: Vorsatzwort</xs:documentation> </xs:annotation> <xs:complexType> <xs:complexContent> <xs:restriction base="Person_Ctp"> <xs:sequence> <xs:element name="Name" type="Name_Stp"/> <xs:element name="Vorname" type="Name_Stp" minOccurs="0"/> <xs:element name="Titel" type="Titel_Stp" minOccurs="0"/> <xs:element name="Geburtsdatum" type="Datum_Stp" minOccurs="0" maxOccurs="0"/> <xs:element name="Geschlecht" type="Geschlecht_Stp" minOccurs="0"/> <xs:element name="Namenszusatz" type="Namenszusatz_Stp" minOccurs="0"/> <xs:element name="Vorsatzwort" type="Vorsatzwort_Stp" minOccurs="0"/> <xs:element name="Bes_schutz_Person" type="Bes_schutz_Person_Stp" minOccurs="0" maxOccurs="0"/> <xs:element name="Erl_bes_schutz_Person" type="Frei_text_Mit_Zeilennum_1000_Stp" minOccurs="0" maxOccurs="0"/> </xs:sequence> </xs:restriction> </xs:complexContent> </xs:complexType> </xs:element></pre>

	<pre> <xs:element name="Genauigkeits_Geburtsdatum" type="Gen_Geburtsdatum_Stp" minOccurs="0" maxOccurs="0"/> </xs:sequence> </xs:restriction> </xs:complexContent> </xs:complexType> </xs:element> </pre>
--	---

element Arzt_Ctp/Person/Name

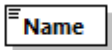
diagram													
namespace	MD:/xml-schema/MD-basis/3.5												
type	Name_Stp												
properties	content simple												
facets	<table border="1"> <thead> <tr> <th>Kind</th> <th>Value</th> <th>Annotation</th> </tr> </thead> <tbody> <tr> <td>minLength</td> <td>1</td> <td></td> </tr> <tr> <td>maxLength</td> <td>45</td> <td></td> </tr> <tr> <td>pattern</td> <td>\S*.[\p{L}].*</td> <td></td> </tr> </tbody> </table>	Kind	Value	Annotation	minLength	1		maxLength	45		pattern	\S*.[\p{L}].*	
Kind	Value	Annotation											
minLength	1												
maxLength	45												
pattern	\S*.[\p{L}].*												
source	<pre><xs:element name="Name" type="Name_Stp"/></pre>												

element Arzt_Ctp/Person/Vorname

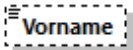
diagram													
namespace	MD:/xml-schema/MD-basis/3.5												
type	Name_Stp												
properties	<table border="1"> <tbody> <tr> <td>minOcc</td> <td>0</td> </tr> <tr> <td>maxOcc</td> <td>1</td> </tr> <tr> <td>content</td> <td>simple</td> </tr> </tbody> </table>	minOcc	0	maxOcc	1	content	simple						
minOcc	0												
maxOcc	1												
content	simple												
facets	<table border="1"> <thead> <tr> <th>Kind</th> <th>Value</th> <th>Annotation</th> </tr> </thead> <tbody> <tr> <td>minLength</td> <td>1</td> <td></td> </tr> <tr> <td>maxLength</td> <td>45</td> <td></td> </tr> <tr> <td>pattern</td> <td>\S*.[\p{L}].*</td> <td></td> </tr> </tbody> </table>	Kind	Value	Annotation	minLength	1		maxLength	45		pattern	\S*.[\p{L}].*	
Kind	Value	Annotation											
minLength	1												
maxLength	45												
pattern	\S*.[\p{L}].*												
source	<pre><xs:element name="Vorname" type="Name_Stp" minOccurs="0"/></pre>												

element Arzt_Ctp/Person/Titel

diagram					
namespace	MD:/xml-schema/MD-basis/3.5				
type	Titel_Stp				
properties	<table border="1"> <tbody> <tr> <td>minOcc</td> <td>0</td> </tr> <tr> <td>maxOcc</td> <td>1</td> </tr> </tbody> </table>	minOcc	0	maxOcc	1
minOcc	0				
maxOcc	1				

	content simple												
facets	<table border="1"> <thead> <tr> <th>Kind</th> <th>Value</th> <th>Annotation</th> </tr> </thead> <tbody> <tr> <td>minLength</td> <td>1</td> <td></td> </tr> <tr> <td>maxLength</td> <td>20</td> <td></td> </tr> <tr> <td>pattern</td> <td>\S*[\p{L}].*</td> <td></td> </tr> </tbody> </table>	Kind	Value	Annotation	minLength	1		maxLength	20		pattern	\S*[\p{L}].*	
Kind	Value	Annotation											
minLength	1												
maxLength	20												
pattern	\S*[\p{L}].*												
source	<xs:element name="Titel" type="Titel_Stp" minOccurs="0"/>												

element Arzt_Ctp/Person/Geburtsdatum

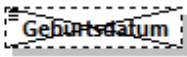
diagram										
namespace	MD:/xml-schema/MD-basis/3.5									
type	Datum_Stp									
properties	<table border="1"> <tbody> <tr> <td>minOcc</td> <td>0</td> </tr> <tr> <td>maxOcc</td> <td>0</td> </tr> <tr> <td>content</td> <td>simple</td> </tr> </tbody> </table>	minOcc	0	maxOcc	0	content	simple			
minOcc	0									
maxOcc	0									
content	simple									
facets	<table border="1"> <thead> <tr> <th>Kind</th> <th>Value</th> <th>Annotation</th> </tr> </thead> <tbody> <tr> <td>minInclusive</td> <td>1850-01-01</td> <td></td> </tr> <tr> <td>maxInclusive</td> <td>2099-12-31</td> <td></td> </tr> </tbody> </table>	Kind	Value	Annotation	minInclusive	1850-01-01		maxInclusive	2099-12-31	
Kind	Value	Annotation								
minInclusive	1850-01-01									
maxInclusive	2099-12-31									
source	<xs:element name="Geburtsdatum" type="Datum_Stp" minOccurs="0" maxOccurs="0"/>									

element Arzt_Ctp/Person/Geschlecht

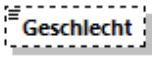
diagram																
namespace	MD:/xml-schema/MD-basis/3.5															
type	Geschlecht_Stp															
properties	<table border="1"> <tbody> <tr> <td>minOcc</td> <td>0</td> </tr> <tr> <td>maxOcc</td> <td>1</td> </tr> <tr> <td>content</td> <td>simple</td> </tr> </tbody> </table>	minOcc	0	maxOcc	1	content	simple									
minOcc	0															
maxOcc	1															
content	simple															
facets	<table border="1"> <thead> <tr> <th>Kind</th> <th>Value</th> <th>Annotation</th> </tr> </thead> <tbody> <tr> <td>enumeration</td> <td>m</td> <td></td> </tr> <tr> <td>enumeration</td> <td>w</td> <td></td> </tr> <tr> <td>enumeration</td> <td>x</td> <td></td> </tr> <tr> <td>enumeration</td> <td>d</td> <td></td> </tr> </tbody> </table>	Kind	Value	Annotation	enumeration	m		enumeration	w		enumeration	x		enumeration	d	
Kind	Value	Annotation														
enumeration	m															
enumeration	w															
enumeration	x															
enumeration	d															
source	<xs:element name="Geschlecht" type="Geschlecht_Stp" minOccurs="0"/>															

element Arzt_Ctp/Person/Namenszusatz

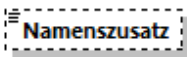
diagram	
namespace	MD:/xml-schema/MD-basis/3.5
type	Namenszusatz_Stp

properties	minOcc 0 maxOcc 1 content simple
facets	Kind Value Annotation minLength 1 maxLength 20 pattern \S*.[\p{L}].*
source	<xs:element name="Namenszusatz" type="Namenszusatz_Stp" minOccurs="0"/>

element Arzt_Ctp/Person/Vorsatzwort

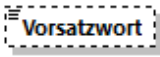
diagram	
namespace	MD/xml-schema/MD-basis/3.5
type	Vorsatzwort_Stp
properties	minOcc 0 maxOcc 1 content simple
facets	Kind Value Annotation minLength 1 maxLength 20 pattern \S*.[\p{L}].*
source	<xs:element name="Vorsatzwort" type="Vorsatzwort_Stp" minOccurs="0"/>

element Arzt_Ctp/Person/Bes_schutz_Person

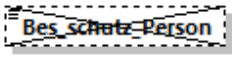
diagram	
namespace	MD/xml-schema/MD-basis/3.5
type	Bes_schutz_Person_Stp
properties	minOcc 0 maxOcc 0 content simple
facets	Kind Value Annotation enumeration 1 enumeration 2
source	<xs:element name="Bes_schutz_Person" type="Bes_schutz_Person_Stp" minOccurs="0" maxOccurs="0"/>

element Arzt_Ctp/Person/Erl_bes_schutz_Person

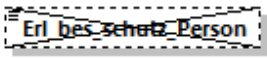
diagram	
namespace	MD/xml-schema/MD-basis/3.5

type	Freitext_Mit_Zeilenum_1000_Stp
properties	minOcc 0 maxOcc 0 content simple
facets	Kind Value Annotation maxLength 1000 pattern \S+[\n\r\t -ÿ]*
source	<code><xs:element name="ErI_bes_schutz_Person" type="Freitext_Mit_Zeilenum_1000_Stp" minOccurs="0" maxOccurs="0"/></code>

element Arzt_Ctp/Person/Genauigkeit_Geburtsdatum

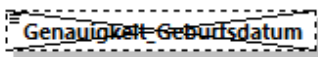
diagram	
namespace	MD:/xml-schema/MD-basis/3.5
type	Gen_Geburtsdatum_Stp
properties	minOcc 0 maxOcc 0 content simple
facets	Kind Value Annotation enumeration 1 enumeration 2
source	<code><xs:element name="Genauigkeit_Geburtsdatum" type="Gen_Geburtsdatum_Stp" minOccurs="0" maxOccurs="0"/></code>

element Arzt_Ctp/Adresse

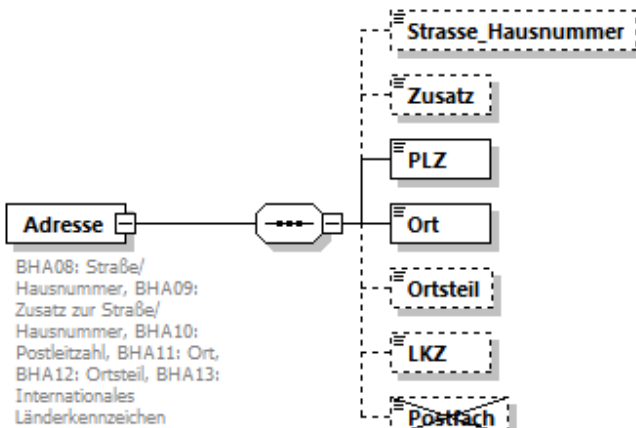
diagram	
namespace	MD:/xml-schema/MD-basis/3.5
type	restriction of Adresse_Ctp
properties	content complex
children	Strasse_Hausnummer Zusatz PLZ Ort Ortsteil LKZ Postfach

annotation	documentation BHA08: Straße/ Hausnummer, BHA09: Zusatz zur Straße/ Hausnummer, BHA10: Postleitzahl, BHA11: Ort, BHA12: Ortsteil, BHA13: Internationales Länderkennzeichen
source	<pre> <xs:element name="Adresse"> <xs:annotation> <xs:documentation>BHA08: Straße/ Hausnummer, BHA09: Zusatz zur Straße/ Hausnummer, BHA10: Postleitzahl, BHA11: Ort, BHA12: Ortsteil, BHA13: Internationales Länderkennzeichen</xs:documentation> </xs:annotation> <xs:complexType> <xs:complexContent> <xs:restriction base="Adresse_Ctp"> <xs:sequence> <xs:element name="Strasse_Hausnummer" type="Strasse_Hausnummer_Stp" minOccurs="0"/> <xs:element name="Zusatz" type="Anschri ftenzusatz_Stp" minOccurs="0"/> <xs:element name="PLZ" type="PLZ_Stp"/> <xs:element name="Ort" type="Ort_Stp"/> <xs:element name="Ortsteil" type="Ort_Stp" minOccurs="0"/> <xs:element name="LKZ" type="LKZ_Stp" minOccurs="0"/> <xs:element name="Postfach" type="Postfach_Stp" minOccurs="0" maxOccurs="0"/> </xs:sequence> </xs:restriction> </xs:complexContent> </xs:complexType> </xs:element> </pre>

element Arzt_Ctp/Adresse/Strasse_Hausnummer

diagram													
namespace	MD:/xml-schema/MD-basis/3.5												
type	Strasse_Hausnummer_Stp												
properties	minOcc 0 maxOcc 1 content simple												
facets	<table border="1"> <thead> <tr> <th>Kind</th> <th>Value</th> <th>Annotation</th> </tr> </thead> <tbody> <tr> <td>minLength</td> <td>1</td> <td></td> </tr> <tr> <td>maxLength</td> <td>56</td> <td></td> </tr> <tr> <td>pattern</td> <td>\S*.*[\p{L}].*</td> <td></td> </tr> </tbody> </table>	Kind	Value	Annotation	minLength	1		maxLength	56		pattern	\S*.*[\p{L}].*	
Kind	Value	Annotation											
minLength	1												
maxLength	56												
pattern	\S*.*[\p{L}].*												
source	<pre> <xs:element name="Strasse_Hausnummer" type="Strasse_Hausnummer_Stp" minOccurs="0"/> </pre>												

element Arzt_Ctp/Adresse/Zusatz

diagram	
namespace	MD:/xml-schema/MD-basis/3.5

type	Anschriftenzusatz_Stp												
properties	minOcc 0 maxOcc 1 content simple												
facets	<table border="1"> <thead> <tr> <th>Kind</th> <th>Value</th> <th>Annotation</th> </tr> </thead> <tbody> <tr> <td>minLength</td> <td>1</td> <td></td> </tr> <tr> <td>maxLength</td> <td>40</td> <td></td> </tr> <tr> <td>pattern</td> <td>\S*.*[\p{L}\p{N}].*</td> <td></td> </tr> </tbody> </table>	Kind	Value	Annotation	minLength	1		maxLength	40		pattern	\S*.*[\p{L}\p{N}].*	
Kind	Value	Annotation											
minLength	1												
maxLength	40												
pattern	\S*.*[\p{L}\p{N}].*												
source	<xs:element name="Zusatz" type="Anschriftenzusatz_Stp" minOccurs="0"/>												

element Arzt_Ctp/Adresse/PLZ

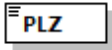
diagram													
namespace	MD/xml-schema/MD-basis/3.5												
type	PLZ_Stp												
properties	content simple												
facets	<table border="1"> <thead> <tr> <th>Kind</th> <th>Value</th> <th>Annotation</th> </tr> </thead> <tbody> <tr> <td>minLength</td> <td>1</td> <td></td> </tr> <tr> <td>maxLength</td> <td>10</td> <td></td> </tr> <tr> <td>pattern</td> <td>\S*.*[\p{L}\p{N}]+.*</td> <td></td> </tr> </tbody> </table>	Kind	Value	Annotation	minLength	1		maxLength	10		pattern	\S*.*[\p{L}\p{N}]+.*	
Kind	Value	Annotation											
minLength	1												
maxLength	10												
pattern	\S*.*[\p{L}\p{N}]+.*												
source	<xs:element name="PLZ" type="PLZ_Stp"/>												

element Arzt_Ctp/Adresse/Ort

diagram													
namespace	MD/xml-schema/MD-basis/3.5												
type	Ort_Stp												
properties	content simple												
facets	<table border="1"> <thead> <tr> <th>Kind</th> <th>Value</th> <th>Annotation</th> </tr> </thead> <tbody> <tr> <td>minLength</td> <td>1</td> <td></td> </tr> <tr> <td>maxLength</td> <td>40</td> <td></td> </tr> <tr> <td>pattern</td> <td>\S*.*[\p{L}].*</td> <td></td> </tr> </tbody> </table>	Kind	Value	Annotation	minLength	1		maxLength	40		pattern	\S*.*[\p{L}].*	
Kind	Value	Annotation											
minLength	1												
maxLength	40												
pattern	\S*.*[\p{L}].*												
source	<xs:element name="Ort" type="Ort_Stp"/>												

element Arzt_Ctp/Adresse/Ortsteil

diagram	
namespace	MD/xml-schema/MD-basis/3.5

type	Ort_Stp
properties	minOcc 0 maxOcc 1 content simple
facets	Kind Value Annotation minLength 1 maxLength 40 pattern \S*.[\p{L}].*
source	<xs:element name="Ortsteil" type="Ort_Stp" minOccurs="0"/>

element Arzt_Ctp/Adresse/LKZ

diagram	
namespace	MD/xml-schema/MD-basis/3.5
type	LKZ_Stp
properties	minOcc 0 maxOcc 1 content simple
facets	Kind Value Annotation minLength 1 maxLength 3 pattern [A-Z]+
source	<xs:element name="LKZ" type="LKZ_Stp" minOccurs="0"/>

element Arzt_Ctp/Adresse/Postfach

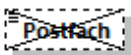
diagram	
namespace	MD/xml-schema/MD-basis/3.5
type	Postfach_Stp
properties	minOcc 0 maxOcc 0 content simple
facets	Kind Value Annotation minLength 1 maxLength 45 pattern \S+ [-ÿ]*
source	<xs:element name="Postfach" type="Postfach_Stp" minOccurs="0" maxOccurs="0"/>

element Arzt_Ctp/Kontakt

diagram	<p>The diagram shows a 'Kontakt' element (dashed box) containing a sequence of four child elements: 'Telefon', 'Telefax', 'Mobiltelefon', and 'Email'. The 'Kontakt' element is annotated with 'BHA14: Telefon, BHA15: Telefax'. The child elements are also annotated with their respective BHA codes: 'Telefon' (BHA14), 'Telefax' (BHA15), 'Mobiltelefon' (BHA14), and 'Email' (BHA15).</p>
namespace	MD:/xml-schema/MD-basis/3.5
type	restriction of Kontaktdaten_Ctp
properties	minOcc 0 maxOcc 1 content complex
children	Telefon Telefax Mobiltelefon Email
annotation	documentation BHA14: Telefon, BHA15: Telefax
source	<pre><xs:element name="Kontakt" minOccurs="0"> <xs:annotation> <xs:documentation>BHA14: Telefon, BHA15: Telefax</xs:documentation> </xs:annotation> <xs:complexType> <xs:complexContent> <xs:restriction base="Kontaktdaten_Ctp"> <xs:sequence> <xs:element name="Telefon" type="Telefon_Stp" minOccurs="0"/> <xs:element name="Telefax" type="Telefax_Stp" minOccurs="0"/> <xs:element name="Mobiltelefon" type="Mobiltelefon_Stp" minOccurs="0" maxOccurs="0"/> <xs:element name="Email" type="Email_Stp" minOccurs="0" maxOccurs="0"/> </xs:sequence> </xs:restriction> </xs:complexContent> </xs:complexType> </xs:element></pre>

element Arzt_Ctp/Kontakt/Telefon

diagram	<p>The diagram shows a 'Telefon' element (dashed box).</p>									
namespace	MD:/xml-schema/MD-basis/3.5									
type	Telefon_Stp									
properties	minOcc 0 maxOcc 1 content simple									
facets	<table border="1"> <thead> <tr> <th>Kind</th> <th>Value</th> <th>Annotation</th> </tr> </thead> <tbody> <tr> <td>minLength</td> <td>1</td> <td></td> </tr> <tr> <td>maxLength</td> <td>20</td> <td></td> </tr> </tbody> </table>	Kind	Value	Annotation	minLength	1		maxLength	20	
Kind	Value	Annotation								
minLength	1									
maxLength	20									

	pattern \S*.[\p{L}\p{N}].*
source	<xs:element name="Telefon" type="Telefon_Stp" minOccurs="0"/>

element Arzt_Ctp/Kontakt/Telefax

diagram													
namespace	MD/xml-schema/MD-basis/3.5												
type	Telefax_Stp												
properties	minOcc 0 maxOcc 1 content simple												
facets	<table border="1"> <thead> <tr> <th>Kind</th> <th>Value</th> <th>Annotation</th> </tr> </thead> <tbody> <tr> <td>minLength</td> <td>1</td> <td></td> </tr> <tr> <td>maxLength</td> <td>20</td> <td></td> </tr> <tr> <td>pattern</td> <td>\S*.[\p{L}\p{N}].*</td> <td></td> </tr> </tbody> </table>	Kind	Value	Annotation	minLength	1		maxLength	20		pattern	\S*.[\p{L}\p{N}].*	
Kind	Value	Annotation											
minLength	1												
maxLength	20												
pattern	\S*.[\p{L}\p{N}].*												
source	<xs:element name="Telefax" type="Telefax_Stp" minOccurs="0"/>												

element Arzt_Ctp/Kontakt/Mobiltelefon

diagram													
namespace	MD/xml-schema/MD-basis/3.5												
type	Mobiltelefon_Stp												
properties	minOcc 0 maxOcc 0 content simple												
facets	<table border="1"> <thead> <tr> <th>Kind</th> <th>Value</th> <th>Annotation</th> </tr> </thead> <tbody> <tr> <td>minLength</td> <td>1</td> <td></td> </tr> <tr> <td>maxLength</td> <td>20</td> <td></td> </tr> <tr> <td>pattern</td> <td>\S*.[\p{L}\p{N}].*</td> <td></td> </tr> </tbody> </table>	Kind	Value	Annotation	minLength	1		maxLength	20		pattern	\S*.[\p{L}\p{N}].*	
Kind	Value	Annotation											
minLength	1												
maxLength	20												
pattern	\S*.[\p{L}\p{N}].*												
source	<xs:element name="Mobiltelefon" type="Mobiltelefon_Stp" minOccurs="0" maxOccurs="0"/>												

element Arzt_Ctp/Kontakt/Email

diagram	
namespace	MD/xml-schema/MD-basis/3.5
type	Email_Stp
properties	minOcc 0 maxOcc 0 content simple

facets	Kind Value Annotation minLength 1 maxLength 50 pattern [\-a-zA-Z0-9\.\+]+\@[a-zA-Z0-9](\.[\-a-zA-Z0-9]*[a-zA-Z0-9])*
source	<xs:element name="Email" type="Email_Stp" minOccurs="0" maxOccurs="0"/>

element Arzt_Ctp/Facharztbezeichnung

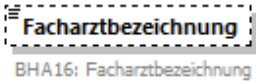
diagram	
namespace	MD:/xml-schema/MD-basis/3.5
type	Facharztbezeichnung_Stp
properties	minOcc 0 maxOcc 1 content simple
facets	Kind Value Annotation minLength 1 maxLength 30 pattern \S+([-ÿ]*
annotation	documentation BHA16: Facharztbezeichnung
source	<xs:element name="Facharztbezeichnung" type="Facharztbezeichnung_Stp" minOccurs="0"> <xs:annotation> <xs:documentation>BHA16: Facharztbezeichnung</xs:documentation> </xs:annotation> </xs:element>

element Arzt_Ctp/Abw_Bez_Anschrift

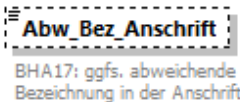
diagram	
namespace	MD:/xml-schema/MD-basis/3.5
type	Abw_Anschrift_Stp
properties	minOcc 0 maxOcc 1 content simple
facets	Kind Value Annotation minLength 1 maxLength 80 pattern \S*.[\p{L}].*
annotation	documentation BHA17: ggfs. abweichende Bezeichnung in der Anschrift
source	<xs:element name="Abw_Bez_Anschrift" type="Abw_Anschrift_Stp" minOccurs="0">

	<pre> <xs: annotation> <xs: documentation>BHA17: ggfs. abweichende Bezeichnung in der Anschrift</xs: documentation> </xs: annotation> </xs: element> </pre>
--	---

complexType Beratungsstelle_MD_Ctp

diagram	
namespace	MD/xml-schema/MD-basis/3.5
children	Beratungsstelle_Nummer Beratungsstelle_Name
used by	element MD_Ctp/Beratungsstelle
annotation	documentation Beratungsstelle des MD
source	<pre> <xs: complexType name="Beratungsstelle_MD_Ctp"> <xs: annotation> <xs: documentation>Beratungsstelle des MD</xs: documentation> </xs: annotation> <xs: sequence> <xs: element name="Beratungsstelle_Nummer" type="Nebenstellenummer_Stp" minOccurs="0"> <xs: annotation> <xs: documentation>GSM02: Nummer der Beratungsstelle</xs: documentation> </xs: annotation> </xs: element> <xs: element name="Beratungsstelle_Name" type="Name_Stp"> <xs: annotation> <xs: documentation>GSM03: Name der Beratungsstelle</xs: documentation> </xs: annotation> </xs: element> </xs: sequence> </xs: complexType> </pre>

element Beratungsstelle_MD_Ctp/Beratungsstelle_Nummer

diagram	
namespace	MD/xml-schema/MD-basis/3.5
type	Nebenstellenummer_Stp

properties	minOcc 0 maxOcc 1 content simple
facets	Kind Value Annotation minLength 1 maxLength 5 pattern \S+ [-ÿ]*
annotation	documentation GSM02: Nummer der Beratungsstelle
source	<xs:element name="Beratungsstelle_Nummer" type="Nebenstellennummer_Stp" minOccurs="0"> <xs:annotation> <xs:documentation>GSM02: Nummer der Beratungsstelle</xs:documentation> </xs:annotation> </xs:element>

element Beratungsstelle_MD_Ctp/Beratungsstelle_Name

diagram	
namespace	MD:/xml-schema/MD-basis/3.5
type	Name Stp
properties	content simple
facets	Kind Value Annotation minLength 1 maxLength 45 pattern \S*.*[\p{L}].*
annotation	documentation GSM03: Name der Beratungsstelle
source	<xs:element name="Beratungsstelle_Name" type="Name_Stp"> <xs:annotation> <xs:documentation>GSM03: Name der Beratungsstelle</xs:documentation> </xs:annotation> </xs:element>

complexType Dokument_Ctp

diagram																									
namespace	MD:/xml-schema/MD-basis/3.5																								
type	extension of xs:base64Binary																								
properties	base xs:base64Binary																								
used by	elements Beauftragung/Dokument Begutachtung/Dokument																								
attributes	<table border="1"> <thead> <tr> <th>Name</th> <th>Type</th> <th>Use</th> <th>Default</th> <th>Fixed</th> <th>Annotation</th> </tr> </thead> <tbody> <tr> <td>mime_type</td> <td>derived by: Freitext Ohne Zeilenumbrueche Stp</td> <td>required</td> <td></td> <td></td> <td>documentation DOK01: MIME-Type</td> </tr> <tr> <td>name</td> <td>derived by: Freitext Ohne Zeilenumbrueche Stp</td> <td>required</td> <td></td> <td></td> <td>documentation DOK02: Name des Dokumentes</td> </tr> <tr> <td>dok_typ</td> <td>derived by: Dok Typ Stp</td> <td>required</td> <td></td> <td></td> <td>documentation DOK03: Dokumententyp</td> </tr> </tbody> </table>	Name	Type	Use	Default	Fixed	Annotation	mime_type	derived by: Freitext Ohne Zeilenumbrueche Stp	required			documentation DOK01: MIME-Type	name	derived by: Freitext Ohne Zeilenumbrueche Stp	required			documentation DOK02: Name des Dokumentes	dok_typ	derived by: Dok Typ Stp	required			documentation DOK03: Dokumententyp
Name	Type	Use	Default	Fixed	Annotation																				
mime_type	derived by: Freitext Ohne Zeilenumbrueche Stp	required			documentation DOK01: MIME-Type																				
name	derived by: Freitext Ohne Zeilenumbrueche Stp	required			documentation DOK02: Name des Dokumentes																				
dok_typ	derived by: Dok Typ Stp	required			documentation DOK03: Dokumententyp																				
annotation	documentation DOK: Dokument																								
source	<pre> <xs:complexType name="Dokument_Ctp"> <xs:annotation> <xs:documentation>DOK: Dokument</xs:documentation> </xs:annotation> <xs:simpleContent> <xs:extension base="xs:base64Binary"> <xs:attribute name="mime_type" use="required"> <xs:annotation> <xs:documentation>DOK01: MIME-Type</xs:documentation> </xs:annotation> <xs:simpleType> <xs:restriction base="Freitext_Ohne_Zeilenumbrueche_Stp"> <xs:minLength value="1"/> </xs:restriction> </xs:simpleType> </xs:attribute> <xs:attribute name="name" use="required"> <xs:annotation> <xs:documentation>DOK02: Name des Dokumentes</xs:documentation> </xs:annotation> <xs:simpleType> <xs:restriction base="Freitext_Ohne_Zeilenumbrueche_Stp"> <xs:minLength value="1"/> </xs:restriction> </xs:simpleType> </xs:extension> </xs:complexType> </pre>																								

	<pre> </xs:restriction> </xs:simpleType> </xs:attribute> <xs:attribute name="dok_typ" use="required"> <xs:annotation> <xs:documentation>DOK03: Dokumententyp</xs:documentation> </xs:annotation> </xs:simpleType> <xs:restriction base="Dok_Typ_Stp" /> </xs:simpleType> </xs:attribute> </xs:extension> </xs:simpleContent> </xs:complexType> </pre>
--	---

attribute Dokument_Ctp/@mime_type

type	restriction of Freitext Ohne Zeilenumbrueche Stp												
properties	use required												
facets	<table border="1"> <thead> <tr> <th>Kind</th> <th>Value</th> <th>Annotation</th> </tr> </thead> <tbody> <tr> <td>minLength</td> <td>1</td> <td></td> </tr> <tr> <td>maxLength</td> <td>255</td> <td></td> </tr> <tr> <td>pattern</td> <td>\S+([&#x0020;-&#x00FF;]*</td> <td></td> </tr> </tbody> </table>	Kind	Value	Annotation	minLength	1		maxLength	255		pattern	\S+([-ÿ]*	
Kind	Value	Annotation											
minLength	1												
maxLength	255												
pattern	\S+([-ÿ]*												
annotation	documentation DOK01: MIME-Type												
source	<pre> <xs:attribute name="mime_type" use="required"> <xs:annotation> <xs:documentation>DOK01: MI ME-Type</xs:documentation> </xs:annotation> <xs:simpleType> <xs:restriction base="Frei text_Ohne_Zei lenumbrueche_Stp"> <xs:minLength value="1" /> </xs:restriction> </xs:simpleType> </xs:attribute> </pre>												

attribute Dokument_Ctp/@name

type	restriction of Freitext Ohne Zeilenumbrueche Stp												
properties	use required												
facets	<table border="1"> <thead> <tr> <th>Kind</th> <th>Value</th> <th>Annotation</th> </tr> </thead> <tbody> <tr> <td>minLength</td> <td>1</td> <td></td> </tr> <tr> <td>maxLength</td> <td>255</td> <td></td> </tr> <tr> <td>pattern</td> <td>\S+([&#x0020;-&#x00FF;]*</td> <td></td> </tr> </tbody> </table>	Kind	Value	Annotation	minLength	1		maxLength	255		pattern	\S+([-ÿ]*	
Kind	Value	Annotation											
minLength	1												
maxLength	255												
pattern	\S+([-ÿ]*												
annotation	documentation DOK02: Name des Dokumentes												
source	<pre> <xs:attribute name="name" use="required"> <xs:annotation> <xs:documentation>DOK02: Name des Dokumentes</xs:documentation> </pre>												

	<pre> </xs:annotation> <xs:simpleType> <xs:restriction base="Frei text_Ohne_Zeilenenumbrueche_Stp"> <xs:minLength value="1"/> </xs:restriction> </xs:simpleType> </xs:attribute> </pre>
--	---

attribute Dokument_Ctp/@dok_typ

type	restriction of Dok_Typ_Stp																								
properties	use required																								
facets	<table border="1"> <thead> <tr> <th>Kind</th> <th>Value</th> <th>Annotation</th> </tr> </thead> <tbody> <tr> <td>enumeration</td> <td>01</td> <td></td> </tr> <tr> <td>enumeration</td> <td>02</td> <td></td> </tr> <tr> <td>enumeration</td> <td>03</td> <td></td> </tr> <tr> <td>enumeration</td> <td>04</td> <td></td> </tr> <tr> <td>enumeration</td> <td>05</td> <td></td> </tr> <tr> <td>enumeration</td> <td>06</td> <td></td> </tr> <tr> <td>enumeration</td> <td>99</td> <td></td> </tr> </tbody> </table>	Kind	Value	Annotation	enumeration	01		enumeration	02		enumeration	03		enumeration	04		enumeration	05		enumeration	06		enumeration	99	
Kind	Value	Annotation																							
enumeration	01																								
enumeration	02																								
enumeration	03																								
enumeration	04																								
enumeration	05																								
enumeration	06																								
enumeration	99																								
annotation	documentation DOK03: Dokumententyp																								
source	<pre> <xs:attribute name="dok_typ" use="required"> <xs:annotation> <xs:documentation>DOK03: Dokumententyp</xs:documentation> </xs:annotation> <xs:simpleType> <xs:restriction base="Dok_Typ_Stp"/> </xs:simpleType> </xs:attribute> </pre>																								

complexType Identifikationsmerkmal_Ctp

<p>diagram</p>	
<p>namespace</p>	<p>MD:/xml-schema/MD-basis/3.5</p>
<p>children</p>	<p>LANR BSNR IK Zahnarztnummer KZV_Bereich</p>
<p>used by</p>	<p>element Arzt_Ctp/Identifikationsmerkmal</p>
<p>annotation</p>	<p>documentation Identifikationsmerkmal</p>
<p>source</p>	<pre><xs:complexType name="Identifikationsmerkmal_Ctp"> <xs:annotation> <xs:documentation>Identifikationsmerkmal</xs:documentation> </xs:annotation> <xs:choice> <xs:element name="LANR" type="LANR_Stp"> <xs:annotation> <xs:documentation>BHA01: Lebenslange Arztnummer (LANR)</xs:documentation> </xs:annotation> </xs:element> <xs:element name="BSNR" type="BSNR_Stp"> <xs:annotation> <xs:documentation>BHA02: Betriebsstättennummer</xs:documentation> </xs:annotation> </xs:element> <xs:element name="IK" type="IK_Stp"> <xs:annotation> <xs:documentation>BHA03: IK-Nummer</xs:documentation> </xs:annotation> </xs:element> <xs:sequence> <xs:element name="Zahnarztnummer" type="Zahnarzt_NR_Stp"> <xs:annotation> <xs:documentation>BHA20: Zahnarztnummer (kodiert)</xs:documentation> </xs:annotation> </xs:element> <xs:element name="KZV_Bereich" type="KZV_Bereich_Stp"> </pre>

	<pre> <xs: annotation> <xs: documentation>BHA21: KZV-Bereich des Zahnarztes</xs: documentation> </xs: annotation> </xs: element> </xs: sequence> </xs: choice> </xs: complexType> </pre>
--	--

element Identifikationsmerkmal_Ctp/LANR

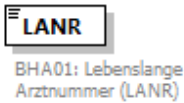
diagram													
namespace	MD:/xml-schema/MD-basis/3.5												
type	LANR_Stp												
properties	content simple												
facets	<table border="1"> <thead> <tr> <th>Kind</th> <th>Value</th> <th>Annotation</th> </tr> </thead> <tbody> <tr> <td>minLength</td> <td>9</td> <td></td> </tr> <tr> <td>maxLength</td> <td>9</td> <td></td> </tr> <tr> <td>pattern</td> <td>[0-9]+</td> <td></td> </tr> </tbody> </table>	Kind	Value	Annotation	minLength	9		maxLength	9		pattern	[0-9]+	
Kind	Value	Annotation											
minLength	9												
maxLength	9												
pattern	[0-9]+												
annotation	documentation BHA01: Lebenslange Arztnummer (LANR)												
source	<pre> <xs: element name="LANR" type="LANR_Stp"> <xs: annotation> <xs: documentation>BHA01: Lebenslange Arztnummer (LANR)</xs: documentation> </xs: annotation> </xs: element> </pre>												

element Identifikationsmerkmal_Ctp/BSNR

diagram													
namespace	MD:/xml-schema/MD-basis/3.5												
type	BSNR_Stp												
properties	content simple												
facets	<table border="1"> <thead> <tr> <th>Kind</th> <th>Value</th> <th>Annotation</th> </tr> </thead> <tbody> <tr> <td>minLength</td> <td>9</td> <td></td> </tr> <tr> <td>maxLength</td> <td>9</td> <td></td> </tr> <tr> <td>pattern</td> <td>[0-9]+</td> <td></td> </tr> </tbody> </table>	Kind	Value	Annotation	minLength	9		maxLength	9		pattern	[0-9]+	
Kind	Value	Annotation											
minLength	9												
maxLength	9												
pattern	[0-9]+												
annotation	documentation BHA02: Betriebsstättennummer												
source	<pre> <xs: element name="BSNR" type="BSNR_Stp"> <xs: annotation> <xs: documentation>BHA02: Betriebsstättennummer</xs: documentation> </xs: annotation> </xs: element> </pre>												

	<pre></xs: annotation> </xs: element></pre>
--	---

element Identifikationsmerkmal_Ctp/IK

diagram													
namespace	MD:/xml-schema/MD-basis/3.5												
type	IK_Stp												
properties	content simple												
facets	<table border="1"> <thead> <tr> <th>Kind</th> <th>Value</th> <th>Annotation</th> </tr> </thead> <tbody> <tr> <td>minLength</td> <td>9</td> <td></td> </tr> <tr> <td>maxLength</td> <td>9</td> <td></td> </tr> <tr> <td>pattern</td> <td>[1-9][0-9]+</td> <td></td> </tr> </tbody> </table>	Kind	Value	Annotation	minLength	9		maxLength	9		pattern	[1-9][0-9]+	
Kind	Value	Annotation											
minLength	9												
maxLength	9												
pattern	[1-9][0-9]+												
annotation	documentation BHA03: IK-Nummer												
source	<pre><xs: element name="IK" type="IK_Stp"> <xs: annotation> <xs: documentation>BHA03: IK-Nummer</xs: documentation> </xs: annotation> </xs: element></pre>												

element Identifikationsmerkmal_Ctp/Zahnarztnummer

diagram													
namespace	MD:/xml-schema/MD-basis/3.5												
type	Zahnarzt_NR_Stp												
properties	content simple												
facets	<table border="1"> <thead> <tr> <th>Kind</th> <th>Value</th> <th>Annotation</th> </tr> </thead> <tbody> <tr> <td>minLength</td> <td>1</td> <td></td> </tr> <tr> <td>maxLength</td> <td>17</td> <td></td> </tr> <tr> <td>pattern</td> <td>\S+ [&#x0020;-&#x00FF;]*</td> <td></td> </tr> </tbody> </table>	Kind	Value	Annotation	minLength	1		maxLength	17		pattern	\S+ [-ÿ]*	
Kind	Value	Annotation											
minLength	1												
maxLength	17												
pattern	\S+ [-ÿ]*												
annotation	documentation BHA20: Zahnarztnummer (kodiert)												
source	<pre><xs: element name="Zahnarztnummer" type="Zahnarzt_NR_Stp"> <xs: annotation> <xs: documentation>BHA20: Zahnarztnummer (kodiert)</xs: documentation> </xs: annotation> </xs: element></pre>												

element Identifikationsmerkmal_Ctp/KZV_Bereich

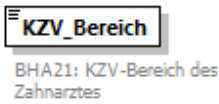
diagram							
namespace	MD:/xml-schema/MD-basis/3.5						
type	KZV_Bereich_Stp						
properties	content simple						
facets	<table border="0"> <tr> <td>Kind</td> <td>Value</td> <td>Annotation</td> </tr> <tr> <td>pattern</td> <td>[0-9]{2}</td> <td></td> </tr> </table>	Kind	Value	Annotation	pattern	[0-9]{2}	
Kind	Value	Annotation					
pattern	[0-9]{2}						
annotation	documentation BHA21: KZV-Bereich des Zahnarztes						
source	<pre> <xs:element name="KZV_Bereich" type="KZV_Bereich_Stp"> <xs:annotation> <xs:documentation>BHA21: KZV-Bereich des Zahnarztes</xs:documentation> </xs:annotation> </xs:element> </pre>						

complexType Kasse_Ctp

<p>diagram</p>	<p>Kasse_Ctp ASK: Stammdaten Kranken-/Pflegekasse</p> <ul style="list-style-type: none"> IK ASK01: IK der Kranken-/Pflegekasse Name ASK03: Name der Kranken-/Pflegekasse Nebestelle (+) ASK02, ASK04 Adresse (+) ASK05: Straße/ Hausnummer, ASK21: Zusatz zur Straße/ Hausnummer, ASK06: Postleitzahl, ASK07: Ort, ASK22: Ortsteil Aktenzeichen (+) ASK08, ASK19, ASK20 Sachbearbeiter ASK09: Sachbearbeiter/ Organisationseinheit Kontakt (+) ASK10: Telefon Sachbearbeiter/ Organisationseinheit, ASK11: Telefax Sachbearbeiter/ Organisationseinheit, ASK12: Sachbearbeiter E-Mail-Adresse Fallnummer ASK13: Fall-Nummer der Krankenkasse Anrede ASK14: Ansprechpartner Anrede SFB_Standort (+) ASK15 - ASK18 Vorherige_SFB (+) ASK23 - ASK25
<p>namespace</p>	<p>MD:/xml-schema/MD-basis/3.5</p>
<p>children</p>	<p>IK Name Nebestelle Adresse Aktenzeichen Sachbearbeiter Kontakt Fallnummer Anrede SFB_Standort Vorherige_SFB</p>
<p>used by</p>	<p>elements Beauftragung/Krankenkasse Begutachtung/Krankenkasse</p>
<p>annotation</p>	<p>documentation</p>

	ASK: Stammdaten Kranken-/Pflegekasse
source	<pre> <xs:complexType name="Kasse_Ctp"> <xs:annotation> <xs:documentation>ASK: Stammdaten Kranken-/Pflegekasse</xs:documentation> </xs:annotation> <xs:sequence> <xs:element name="IK" type="IK_Stp"> <xs:annotation> <xs:documentation>ASK01: IK der Kranken-/Pflegekasse</xs:documentation> </xs:annotation> </xs:element> <xs:element name="Name" type="Name_Stp"> <xs:annotation> <xs:documentation>ASK03: Name der Kranken-/Pflegekasse</xs:documentation> </xs:annotation> </xs:element> <xs:element name="Nebenstelle" type="Nebenstelle_Kasse_Ctp" minOccurs="0"> <xs:annotation> <xs:documentation>ASK02, ASK04</xs:documentation> </xs:annotation> </xs:element> <xs:element name="Adresse"> <xs:annotation> <xs:documentation>ASK05: Straße/ Hausnummer, ASK21: Zusatz zur Straße/ Hausnummer, ASK06: Postleitzahl, ASK07: Ort, ASK22: Ortsteil</xs:documentation> </xs:annotation> <xs:complexType> <xs:complexContent> <xs:restriction base="Adresse_Ctp"> <xs:sequence> <xs:element name="Strasse_Hausnummer" type="Strasse_Hausnummer_Stp" minOccurs="0"/> <xs:element name="Zusatz" type="Anschriftenzusatz_Stp" minOccurs="0"/> <xs:element name="PLZ" type="PLZ_Stp"/> <xs:element name="Ort" type="Ort_Stp"/> <xs:element name="Ortsteil" type="Ort_Stp" minOccurs="0"/> <xs:element name="LKZ" type="LKZ_Stp" minOccurs="0" maxOccurs="0"/> <xs:element name="Postfach" type="Postfach_Stp" minOccurs="0" maxOccurs="0"/> </xs:sequence> </xs:restriction> </xs:complexContent> </xs:complexType> </xs:element> <xs:element name="Aktenzeichen" type="Aktenzeichen_Ctp"> <xs:annotation> <xs:documentation>ASK08, ASK19, ASK20</xs:documentation> </xs:annotation> </xs:element> <xs:element name="Sachbearbeiter" type="Sachbearbeiter_Orga_Stp"> <xs:annotation> <xs:documentation>ASK09: Sachbearbeiter/ Organisationseinheit</xs:documentation> </pre>

```

</xs:annotati on>
</xs:el ement>
<xs:el ement name="Kontakt">
  <xs:annotati on>
    <xs:documentati on>ASK10: Telefon Sachbearbei ter/ Organi sati onsei nhei t,
ASK11: Tel efax Sachbearbei ter/ Organi sati onsei nhei t, ASK12: Sachbearbei ter
E-Mai l -Adresse</xs:documentati on>
  </xs:annotati on>
  <xs:compl exType>
    <xs:compl exContent>
      <xs:restricti on base="Kontaktdaten_Ctp">
        <xs:sequence>
          <xs:el ement name="Tel efon" type="Tel efon_Stp"/>
          <xs:el ement name="Tel efax" type="Tel efax_Stp" mi n0ccurs="0"/>
          <xs:el ement name="Mobi l tel efon" type="Mobi l tel efon_Stp"
mi n0ccurs="0" max0ccurs="0"/>
          <xs:el ement name="Emai l " type="Emai l _Stp" mi n0ccurs="0"/>
        </xs:sequence>
      </xs:restricti on>
    </xs:compl exContent>
  </xs:compl exType>
</xs:el ement>
<xs:el ement name="Fal lnummer" type="Fal lnummer_Stp" mi n0ccurs="0">
  <xs:annotati on>
    <xs:documentati on>ASK13: Fal l -Nummer der Krankenkasse</xs:documentati on>
  </xs:annotati on>
</xs:el ement>
<xs:el ement name="Anrede" type="Anrede_Stp" mi n0ccurs="0">
  <xs:annotati on>
    <xs:documentati on>ASK14: Ansprechpartner Anrede</xs:documentati on>
  </xs:annotati on>
</xs:el ement>
<xs:el ement name="SFB_Standort" type="SFB_Standort_Ctp" mi n0ccurs="0">
  <xs:annotati on>
    <xs:documentati on>ASK15 - ASK18</xs:documentati on>
  </xs:annotati on>
</xs:el ement>
<xs:el ement name="Vorheri ge_SFB" type="Vorheri ge_SFB_Ctp" mi n0ccurs="0">
  <xs:annotati on>
    <xs:documentati on>ASK23 - ASK25</xs:documentati on>
  </xs:annotati on>
</xs:el ement>
</xs:sequence>
</xs:compl exType>

```

element Kasse_Ctp/IK

diagram	
namespace	MD:/xml-schema/MD-basis/3.5

type	IK_Stp												
properties	content simple												
facets	<table border="1"> <thead> <tr> <th>Kind</th> <th>Value</th> <th>Annotation</th> </tr> </thead> <tbody> <tr> <td>minLength</td> <td>9</td> <td></td> </tr> <tr> <td>maxLength</td> <td>9</td> <td></td> </tr> <tr> <td>pattern</td> <td>[1-9][0-9]+</td> <td></td> </tr> </tbody> </table>	Kind	Value	Annotation	minLength	9		maxLength	9		pattern	[1-9][0-9]+	
Kind	Value	Annotation											
minLength	9												
maxLength	9												
pattern	[1-9][0-9]+												
annotation	documentation ASK01: IK der Kranken-/Pflegekasse												
source	<pre><xs:element name="IK" type="IK_Stp"> <xs:annotation> <xs:documentation>ASK01: IK der Kranken-/Pflegekasse</xs:documentation> </xs:annotation> </xs:element></pre>												

element Kasse_Ctp/Name

diagram													
namespace	MD:/xml-schema/MD-basis/3.5												
type	Name_Stp												
properties	content simple												
facets	<table border="1"> <thead> <tr> <th>Kind</th> <th>Value</th> <th>Annotation</th> </tr> </thead> <tbody> <tr> <td>minLength</td> <td>1</td> <td></td> </tr> <tr> <td>maxLength</td> <td>45</td> <td></td> </tr> <tr> <td>pattern</td> <td>\S*.[\p{L}].*</td> <td></td> </tr> </tbody> </table>	Kind	Value	Annotation	minLength	1		maxLength	45		pattern	\S*.[\p{L}].*	
Kind	Value	Annotation											
minLength	1												
maxLength	45												
pattern	\S*.[\p{L}].*												
annotation	documentation ASK03: Name der Kranken-/Pflegekasse												
source	<pre><xs:element name="Name" type="Name_Stp"> <xs:annotation> <xs:documentation>ASK03: Name der Kranken-/Pflegekasse</xs:documentation> </xs:annotation> </xs:element></pre>												

element Kasse_Ctp/Nebenstelle

diagram	
---------	--

namespace	MD:/xml-schema/MD-basis/3.5
type	Nebestelle_Kasse_Ctp
properties	minOcc 0 maxOcc 1 content complex
children	Nebestelle_Nummer Nebestelle_Name
annotation	documentation ASK02, ASK04
source	<pre><xs:element name="Nebestelle" type="Nebestelle_Kasse_Ctp" minOccurs="0"> <xs:annotation> <xs:documentation>ASK02, ASK04</xs:documentation> </xs:annotation> </xs:element></pre>

element Kasse_Ctp/Adresse

diagram	<p>ASK05: Straße/ Hausnummer, ASK21: Zusatz zur Straße/ Hausnummer, ASK06: Postleitzahl, ASK07: Ort, ASK22: Ortsteil</p>
namespace	MD:/xml-schema/MD-basis/3.5
type	restriction of Adresse_Ctp
properties	content complex
children	Strasse_Hausnummer Zusatz PLZ Ort Ortsteil LKZ Postfach
annotation	documentation ASK05: Straße/ Hausnummer, ASK21: Zusatz zur Straße/ Hausnummer, ASK06: Postleitzahl, ASK07: Ort, ASK22: Ortsteil
source	<pre><xs:element name="Adresse"> <xs:annotation> <xs:documentation>ASK05: Straße/ Hausnummer, ASK21: Zusatz zur Straße/ Hausnummer, ASK06: Postleitzahl, ASK07: Ort, ASK22: Ortsteil</xs:documentation> </xs:annotation> <xs:complexType> <xs:complexContent> <xs:restriction base="Adresse_Ctp"> <xs:sequence> <xs:element name="Strasse_Hausnummer" type="Strasse_Hausnummer_Stp" minOccurs="0"/> <xs:element name="Zusatz" type="Anschri ftenzusatz_Stp" minOccurs="0"/></pre>

	<pre> <xs:element name="PLZ" type="PLZ_Stp"/> <xs:element name="Ort" type="Ort_Stp"/> <xs:element name="Ortsteil" type="Ort_Stp" minOccurs="0"/> <xs:element name="LKZ" type="LKZ_Stp" minOccurs="0" maxOccurs="0"/> <xs:element name="Postfach" type="Postfach_Stp" minOccurs="0" maxOccurs="0"/> </xs:sequence> </xs:restriction> </xs:complexContent> </xs:complexType> </xs:element> </pre>
--	---

element Kasse_Ctp/Adresse/Strasse_Hausnummer

diagram													
namespace	MD:/xml-schema/MD-basis/3.5												
type	Strasse_Hausnummer_Stp												
properties	minOcc 0 maxOcc 1 content simple												
facets	<table border="1"> <thead> <tr> <th>Kind</th> <th>Value</th> <th>Annotation</th> </tr> </thead> <tbody> <tr> <td>minLength</td> <td>1</td> <td></td> </tr> <tr> <td>maxLength</td> <td>56</td> <td></td> </tr> <tr> <td>pattern</td> <td>\S*.[\p{L}].*</td> <td></td> </tr> </tbody> </table>	Kind	Value	Annotation	minLength	1		maxLength	56		pattern	\S*.[\p{L}].*	
Kind	Value	Annotation											
minLength	1												
maxLength	56												
pattern	\S*.[\p{L}].*												
source	<pre><xs:element name="Strasse_Hausnummer" type="Strasse_Hausnummer_Stp" minOccurs="0"/></pre>												

element Kasse_Ctp/Adresse/Zusatz

diagram													
namespace	MD:/xml-schema/MD-basis/3.5												
type	Anschriftenzusatz_Stp												
properties	minOcc 0 maxOcc 1 content simple												
facets	<table border="1"> <thead> <tr> <th>Kind</th> <th>Value</th> <th>Annotation</th> </tr> </thead> <tbody> <tr> <td>minLength</td> <td>1</td> <td></td> </tr> <tr> <td>maxLength</td> <td>40</td> <td></td> </tr> <tr> <td>pattern</td> <td>\S*.[\p{L}\p{N}].*</td> <td></td> </tr> </tbody> </table>	Kind	Value	Annotation	minLength	1		maxLength	40		pattern	\S*.[\p{L}\p{N}].*	
Kind	Value	Annotation											
minLength	1												
maxLength	40												
pattern	\S*.[\p{L}\p{N}].*												
source	<pre><xs:element name="Zusatz" type="Anschriftenzusatz_Stp" minOccurs="0"/></pre>												

element Kasse_Ctp/Adresse/PLZ

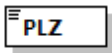
diagram													
namespace	MD:/xml-schema/MD-basis/3.5												
type	PLZ_Stp												
properties	content simple												
facets	<table border="1"> <thead> <tr> <th>Kind</th> <th>Value</th> <th>Annotation</th> </tr> </thead> <tbody> <tr> <td>minLength</td> <td>1</td> <td></td> </tr> <tr> <td>maxLength</td> <td>10</td> <td></td> </tr> <tr> <td>pattern</td> <td>\S*.*[\p{L}\p{N}+].*</td> <td></td> </tr> </tbody> </table>	Kind	Value	Annotation	minLength	1		maxLength	10		pattern	\S*.*[\p{L}\p{N}+].*	
Kind	Value	Annotation											
minLength	1												
maxLength	10												
pattern	\S*.*[\p{L}\p{N}+].*												
source	<code><xs:element name="PLZ" type="PLZ_Stp"/></code>												

element Kasse_Ctp/Adresse/Ort

diagram													
namespace	MD:/xml-schema/MD-basis/3.5												
type	Ort_Stp												
properties	content simple												
facets	<table border="1"> <thead> <tr> <th>Kind</th> <th>Value</th> <th>Annotation</th> </tr> </thead> <tbody> <tr> <td>minLength</td> <td>1</td> <td></td> </tr> <tr> <td>maxLength</td> <td>40</td> <td></td> </tr> <tr> <td>pattern</td> <td>\S*.*[\p{L}].*</td> <td></td> </tr> </tbody> </table>	Kind	Value	Annotation	minLength	1		maxLength	40		pattern	\S*.*[\p{L}].*	
Kind	Value	Annotation											
minLength	1												
maxLength	40												
pattern	\S*.*[\p{L}].*												
source	<code><xs:element name="Ort" type="Ort_Stp"/></code>												

element Kasse_Ctp/Adresse/Ortsteil

diagram													
namespace	MD:/xml-schema/MD-basis/3.5												
type	Ort_Stp												
properties	<table border="1"> <tbody> <tr> <td>minOcc</td> <td>0</td> </tr> <tr> <td>maxOcc</td> <td>1</td> </tr> <tr> <td>content</td> <td>simple</td> </tr> </tbody> </table>	minOcc	0	maxOcc	1	content	simple						
minOcc	0												
maxOcc	1												
content	simple												
facets	<table border="1"> <thead> <tr> <th>Kind</th> <th>Value</th> <th>Annotation</th> </tr> </thead> <tbody> <tr> <td>minLength</td> <td>1</td> <td></td> </tr> <tr> <td>maxLength</td> <td>40</td> <td></td> </tr> <tr> <td>pattern</td> <td>\S*.*[\p{L}].*</td> <td></td> </tr> </tbody> </table>	Kind	Value	Annotation	minLength	1		maxLength	40		pattern	\S*.*[\p{L}].*	
Kind	Value	Annotation											
minLength	1												
maxLength	40												
pattern	\S*.*[\p{L}].*												
source	<code><xs:element name="Ortsteil" type="Ort_Stp" minOccurs="0"/></code>												

element Kasse_Ctp/Adresse/LKZ

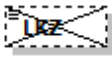
diagram	
namespace	MD:/xml-schema/MD-basis/3.5
type	LKZ_Stp
properties	minOcc 0 maxOcc 0 content simple
facets	Kind Value Annotation minLength 1 maxLength 3 pattern [A-Z]+
source	<code><xs:element name="LKZ" type="LKZ_Stp" minOccurs="0" maxOccurs="0"/></code>

element Kasse_Ctp/Adresse/Postfach

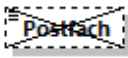
diagram	
namespace	MD:/xml-schema/MD-basis/3.5
type	Postfach_Stp
properties	minOcc 0 maxOcc 0 content simple
facets	Kind Value Annotation minLength 1 maxLength 45 pattern \S+([-ÿ:]+)
source	<code><xs:element name="Postfach" type="Postfach_Stp" minOccurs="0" maxOccurs="0"/></code>

element Kasse_Ctp/Aktenzeichen

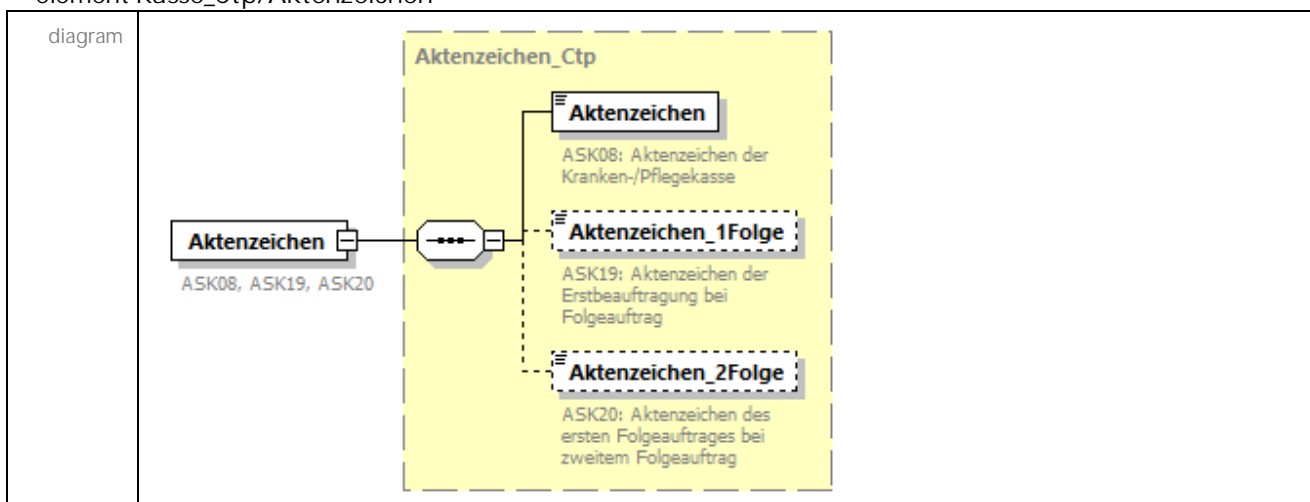

namespace	MD:/xml-schema/MD-basis/3.5
type	Aktenzeichen_Ctp
properties	content complex
children	Aktenzeichen Aktenzeichen_1Folge Aktenzeichen_2Folge
annotation	documentation ASK08, ASK19, ASK20
source	<pre><xs:element name="Aktenzeichen" type="Aktenzeichen_Ctp"> <xs:annotation> <xs:documentation>ASK08, ASK19, ASK20</xs:documentation> </xs:annotation> </xs:element></pre>

element Kasse_Ctp/Sachbearbeiter

diagram													
namespace	MD:/xml-schema/MD-basis/3.5												
type	Sachbearbeiter_Orga_Stp												
properties	content simple												
facets	<table border="1"> <thead> <tr> <th>Kind</th> <th>Value</th> <th>Annotation</th> </tr> </thead> <tbody> <tr> <td>minLength</td> <td>2</td> <td></td> </tr> <tr> <td>maxLength</td> <td>30</td> <td></td> </tr> <tr> <td>pattern</td> <td>\S+ [&#x0020;-&#x00FF;]*</td> <td></td> </tr> </tbody> </table>	Kind	Value	Annotation	minLength	2		maxLength	30		pattern	\S+ [-ÿ]*	
Kind	Value	Annotation											
minLength	2												
maxLength	30												
pattern	\S+ [-ÿ]*												
annotation	documentation ASK09: Sachbearbeiter/ Organisationseinheit												
source	<pre><xs:element name="Sachbearbeiter" type="Sachbearbeiter_Orga_Stp"> <xs:annotation> <xs:documentation>ASK09: Sachbearbeiter/ Organi sationsei nheit</xs:documentation> </xs:annotation> </xs:element></pre>												

element Kasse_Ctp/Kontakt

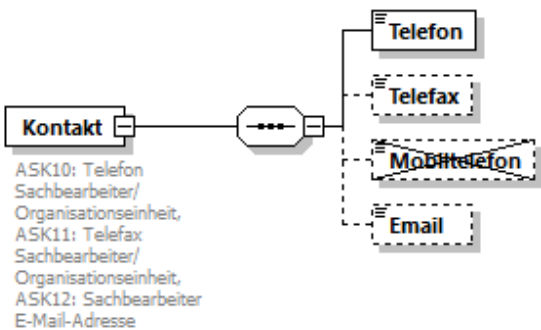
diagram	
---------	---

namespace	MD:/xml-schema/MD-basis/3.5
type	restriction of Kontaktdaten_Ctp
properties	content complex
children	Telefon Telefax Mobiltelefon Email
annotation	documentation ASK10: Telefon Sachbearbeiter/ Organisationseinheit, ASK11: Telefax Sachbearbeiter/ Organisationseinheit, ASK12: Sachbearbeiter E-Mail-Adresse
source	<pre> <xs:element name="Kontakt"> <xs:annotation> <xs:documentation>ASK10: Telefon Sachbearbeiter/ Organisationseinheit, ASK11: Telefax Sachbearbeiter/ Organisationseinheit, ASK12: Sachbearbeiter E-Mail-Adresse</xs:documentation> </xs:annotation> <xs:complexType> <xs:complexContent> <xs:restriction base="Kontaktdaten_Ctp"> <xs:sequence> <xs:element name="Telefon" type="Telefon_Stp"/> <xs:element name="Telefax" type="Telefax_Stp" minOccurs="0"/> <xs:element name="Mobiltelefon" type="Mobiltelefon_Stp" minOccurs="0" maxOccurs="0"/> <xs:element name="Email" type="Email_Stp" minOccurs="0"/> </xs:sequence> </xs:restriction> </xs:complexContent> </xs:complexType> </xs:element> </pre>

element Kasse_Ctp/Kontakt/Telefon

diagram													
namespace	MD:/xml-schema/MD-basis/3.5												
type	Telefon_Stp												
properties	content simple												
facets	<table border="1"> <thead> <tr> <th>Kind</th> <th>Value</th> <th>Annotation</th> </tr> </thead> <tbody> <tr> <td>minLength</td> <td>1</td> <td></td> </tr> <tr> <td>maxLength</td> <td>20</td> <td></td> </tr> <tr> <td>pattern</td> <td>\S*.[\p{L}\p{N}].*</td> <td></td> </tr> </tbody> </table>	Kind	Value	Annotation	minLength	1		maxLength	20		pattern	\S*.[\p{L}\p{N}].*	
Kind	Value	Annotation											
minLength	1												
maxLength	20												
pattern	\S*.[\p{L}\p{N}].*												
source	<pre><xs:element name="Telefon" type="Telefon_Stp"/></pre>												

element Kasse_Ctp/Kontakt/Telefax

diagram	
---------	---

namespace	MD:/xml-schema/MD-basis/3.5
type	Telefax_Stp
properties	minOcc 0 maxOcc 1 content simple
facets	Kind Value Annotation minLength 1 maxLength 20 pattern \S*.[\p{L}\p{N}].*
source	<xs:element name="Telefax" type="Telefax_Stp" minOccurs="0"/>

element Kasse_Ctp/Kontakt/Mobiltelefon

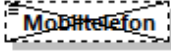
diagram	
namespace	MD:/xml-schema/MD-basis/3.5
type	Mobiltelefon_Stp
properties	minOcc 0 maxOcc 0 content simple
facets	Kind Value Annotation minLength 1 maxLength 20 pattern \S*.[\p{L}\p{N}].*
source	<xs:element name="Mobiltelefon" type="Mobiltelefon_Stp" minOccurs="0" maxOccurs="0"/>

element Kasse_Ctp/Kontakt/Email

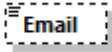
diagram	
namespace	MD:/xml-schema/MD-basis/3.5
type	Email_Stp
properties	minOcc 0 maxOcc 1 content simple
facets	Kind Value Annotation minLength 1 maxLength 50 pattern [_\-\a-zA-Z0-9\.\+]+@[a-zA-Z0-9](\.[\-\a-zA-Z0-9]*[a-zA-Z0-9])*
source	<xs:element name="Email" type="Email_Stp" minOccurs="0"/>

element Kasse_Ctp/Fallnummer

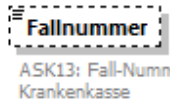
diagram													
namespace	MD:/xml-schema/MD-basis/3.5												
type	Fallnummer_Stp												
properties	minOcc 0 maxOcc 1 content simple												
facets	<table border="1"> <thead> <tr> <th>Kind</th> <th>Value</th> <th>Annotation</th> </tr> </thead> <tbody> <tr> <td>minLength</td> <td>1</td> <td></td> </tr> <tr> <td>maxLength</td> <td>50</td> <td></td> </tr> <tr> <td>pattern</td> <td>\S+[\&#x0020;-&#x00FF;]*</td> <td></td> </tr> </tbody> </table>	Kind	Value	Annotation	minLength	1		maxLength	50		pattern	\S+[\ -ÿ]*	
Kind	Value	Annotation											
minLength	1												
maxLength	50												
pattern	\S+[\ -ÿ]*												
annotation	documentation ASK13: Fall-Nummer der Krankenkasse												
source	<pre><xs:element name="Fallnummer" type="Fallnummer_Stp" minOccurs="0"> <xs:annotation> <xs:documentation>ASK13: Fall-Nummer der Krankenkasse</xs:documentation> </xs:annotation> </xs:element></pre>												

element Kasse_Ctp/Anrede

diagram													
namespace	MD:/xml-schema/MD-basis/3.5												
type	Anrede_Stp												
properties	minOcc 0 maxOcc 1 content simple												
facets	<table border="1"> <thead> <tr> <th>Kind</th> <th>Value</th> <th>Annotation</th> </tr> </thead> <tbody> <tr> <td>minLength</td> <td>1</td> <td></td> </tr> <tr> <td>maxLength</td> <td>10</td> <td></td> </tr> <tr> <td>pattern</td> <td>\S*.[\p{L}].*</td> <td></td> </tr> </tbody> </table>	Kind	Value	Annotation	minLength	1		maxLength	10		pattern	\S*.[\p{L}].*	
Kind	Value	Annotation											
minLength	1												
maxLength	10												
pattern	\S*.[\p{L}].*												
annotation	documentation ASK14: Ansprechpartner Anrede												
source	<pre><xs:element name="Anrede" type="Anrede_Stp" minOccurs="0"> <xs:annotation> <xs:documentation>ASK14: Ansprechpartner Anrede</xs:documentation> </xs:annotation> </xs:element></pre>												

element Kasse_Ctp/SFB_Standort

<p>diagram</p>	
<p>namespace</p>	<p>MD:/xml-schema/MD-basis/3.5</p>
<p>type</p>	<p>SFB_Standort_Ctp</p>
<p>properties</p>	<p>minOcc 0 maxOcc 1 content complex</p>
<p>children</p>	<p>Name Strasse_Hausnummer PLZ Ort</p>
<p>annotation</p>	<p>documentation ASK15 - ASK18</p>
<p>source</p>	<pre><xs:element name="SFB_Standort" type="SFB_Standort_Ctp" minOccurs="0"> <xs:annotation> <xs:documentation>ASK15 - ASK18</xs:documentation> </xs:annotation> </xs:element></pre>

element Kasse_Ctp/Vorherige_SFB

<p>diagram</p>	
<p>namespace</p>	<p>MD:/xml-schema/MD-basis/3.5</p>

type	Vorherige_SFB_Ctp
properties	minOcc 0 maxOcc 1 content complex
children	Datum Ort Name MD
annotation	documentation ASK23 - ASK25
source	<pre><xs:element name="Vorherige_SFB" type="Vorherige_SFB_Ctp" minOccurs="0"> <xs:annotation> <xs:documentation>ASK23 - ASK25</xs:documentation> </xs:annotation> </xs:element></pre>

complexType Kontaktdaten_Ctp

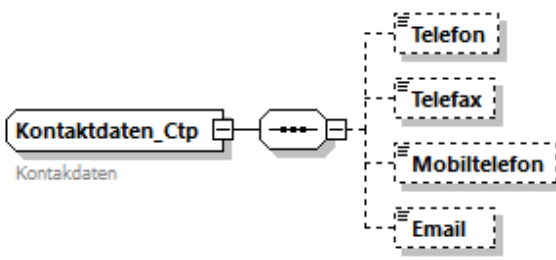
diagram	
namespace	MD:/xml-schema/MD-basis/3.5
children	Telefon Telefax Mobiltelefon Email
used by	elements Adressat Oder Adresse_Ctp/Kontakt Arzt_Ctp/Kontakt Kasse_Ctp/Kontakt Leistungserbringer_Ctp/Kontakt MD_Ctp/Kontakt Versicherter_Ctp/Kontakt
annotation	documentation Kontakt
source	<pre><xs:complexType name="Kontakt" > <xs:annotation> <xs:documentation>Kontakt</xs:documentation> </xs:annotation> <xs:sequence> <xs:element name="Telefon" type="Telefon_Stp" minOccurs="0"/> <xs:element name="Telefax" type="Telefax_Stp" minOccurs="0"/> <xs:element name="Mobiltelefon" type="Mobiltelefon_Stp" minOccurs="0"/> <xs:element name="Email" type="Email_Stp" minOccurs="0"/> </xs:sequence> </xs:complexType></pre>

element Kontaktdaten_Ctp/Telefon

diagram	
namespace	MD:/xml-schema/MD-basis/3.5
type	Telefon_Stp

properties	minOcc 0 maxOcc 1 content simple
facets	Kind Value Annotation minLength 1 maxLength 20 pattern \S*.[\p{L}\p{N}].*
source	<xs:element name="Telefon" type="Telefon_Stp" minOccurs="0"/>

element Kontaktdaten_Ctp/Telefax

diagram	
namespace	MD:/xml-schema/MD-basis/3.5
type	Telefax_Stp
properties	minOcc 0 maxOcc 1 content simple
facets	Kind Value Annotation minLength 1 maxLength 20 pattern \S*.[\p{L}\p{N}].*
source	<xs:element name="Telefax" type="Telefax_Stp" minOccurs="0"/>

element Kontaktdaten_Ctp/Mobiltelefon

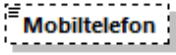
diagram	
namespace	MD:/xml-schema/MD-basis/3.5
type	Mobiltelefon_Stp
properties	minOcc 0 maxOcc 1 content simple
facets	Kind Value Annotation minLength 1 maxLength 20 pattern \S*.[\p{L}\p{N}].*
source	<xs:element name="Mobiltelefon" type="Mobiltelefon_Stp" minOccurs="0"/>

element Kontaktdaten_Ctp/Email

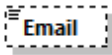
diagram	
namespace	MD:/xml-schema/MD-basis/3.5

type	Email_Stp
properties	minOcc 0 maxOcc 1 content simple
facets	Kind Value Annotation minLength 1 maxLength 50 pattern [_\-\a-zA-Z0-9\.\+\]+\@[a-zA-Z0-9](\.[\-\a-zA-Z0-9]*[a-zA-Z0-9])*
source	<xs:element name="Email" type="Email_Stp" minOccurs="0"/>

complexType Leistungserbringer_Ctp

diagram	<p>Leistungserbringer_Ctp SDL: Stammdaten Leistungserbringer</p> <ul style="list-style-type: none"> IK SDL01: IK des Leistungserbringers Name SDL02: Name des Leistungserbringers Name_Geschaeft SDL03: Name des Geschäftes/ Standort Adresse SDL04: Straße/ Hausnummer, SDL05: Zusatz zu Straße/ Hausnummer, SDL08: Postleitzahl, SDL06: Ort, SDL07: Ortsteil, SDL09: Internationales Länderkennzeichen, SDL14: Postfach Kontakt SDL10: Telefon, SDL11: Telefax, SDL12: Mobiltelefon, SDL13: Email
namespace	MD:/xml-schema/MD-basis/3.5
children	IK Name Name_Geschaeft Adresse Kontakt
used by	element Beauftragung/Auftrag/Infos/Leistungserbringer
annotation	documentation SDL: Stammdaten Leistungserbringer
source	<pre><xs:complexType name="Leistungserbringer_Ctp"> <xs:annotation> <xs:documentation>SDL: Stammdaten Leistungserbringer</xs:documentation> </xs:annotation> <xs:sequence> <xs:element name="IK" type="IK_Stp"> <xs:annotation> <xs:documentation>SDL01: IK des Leistungserbringers</xs:documentation> </xs:annotation> </pre>

```

</xs:element>
<xs:element name="Name" type="Name_Stp">
  <xs:annotation>
    <xs:documentation>SDL02: Name des Leistungserbringers</xs:documentation>
  </xs:annotation>
</xs:element>
<xs:element name="Name_Geschaeft" type="Name_Stp" minOccurs="0">
  <xs:annotation>
    <xs:documentation>SDL03: Name des Geschäftes/ Standort</xs:documentation>
  </xs:annotation>
</xs:element>
<xs:element name="Adresse" minOccurs="0">
  <xs:annotation>
    <xs:documentation>SDL04: Straße/ Hausnummer, SDL05: Zusatz zu Straße/
Hausnummer, SDL08: Postleitzahl, SDL06: Ort, SDL07: Ortsteil, SDL09: Internationales
Länderkennzeichen, SDL14: Postfach</xs:documentation>
  </xs:annotation>
  <xs:complexType>
    <xs:complexContent>
      <xs:restriction base="Adresse_Ctp">
        <xs:sequence>
          <xs:element name="Strasse_Hausnummer" type="Strasse_Hausnummer_Stp"
minOccurs="0"/>
          <xs:element name="Zusatz" type="Anschri ftenzusatz_Stp"
minOccurs="0"/>
          <xs:element name="PLZ" type="PLZ_Stp" minOccurs="0"/>
          <xs:element name="Ort" type="Ort_Stp" minOccurs="0"/>
          <xs:element name="Ortsteil" type="Ort_Stp" minOccurs="0"/>
          <xs:element name="LKZ" type="LKZ_Stp" minOccurs="0"/>
          <xs:element name="Postfach" type="Postfach_Stp" minOccurs="0"/>
        </xs:sequence>
      </xs:restriction>
    </xs:complexContent>
  </xs:complexType>
</xs:element>
<xs:element name="Kontakt" minOccurs="0">
  <xs:annotation>
    <xs:documentation>SDL10: Telefon, SDL11: Telefax, SDL12: Mobiltelefon,
SDL13: Email</xs:documentation>
  </xs:annotation>
  <xs:complexType>
    <xs:complexContent>
      <xs:restriction base="Kontaktdaten_Ctp">
        <xs:sequence>
          <xs:element name="Telefon" type="Telefon_Stp" minOccurs="0"/>
          <xs:element name="Telefax" type="Telefax_Stp" minOccurs="0"/>
          <xs:element name="Mobiltelefon" type="Mobiltelefon_Stp"
minOccurs="0"/>
          <xs:element name="Email" type="Email_Stp" minOccurs="0"/>
        </xs:sequence>
      </xs:restriction>
    </xs:complexContent>
  </xs:complexType>
</xs:element>
</xs:sequence>

```

</xs:complexType>

element Leistungserbringer_Ctp/IK

diagram													
namespace	MD:/xml-schema/MD-basis/3.5												
type	IK_Stp												
properties	content simple												
facets	<table><thead><tr><th>Kind</th><th>Value</th><th>Annotation</th></tr></thead><tbody><tr><td>minLength</td><td>9</td><td></td></tr><tr><td>maxLength</td><td>9</td><td></td></tr><tr><td>pattern</td><td>[1-9][0-9]+</td><td></td></tr></tbody></table>	Kind	Value	Annotation	minLength	9		maxLength	9		pattern	[1-9][0-9]+	
Kind	Value	Annotation											
minLength	9												
maxLength	9												
pattern	[1-9][0-9]+												
annotation	documentation SDL01: IK des Leistungserbringers												
source	<pre><xs:element name="IK" type="IK_Stp"> <xs:annotation> <xs:documentation>SDL01: IK des Leistungserbringers</xs:documentation> </xs:annotation> </xs:element></pre>												

element Leistungserbringer_Ctp/Name

diagram													
namespace	MD:/xml-schema/MD-basis/3.5												
type	Name_Stp												
properties	content simple												
facets	<table><thead><tr><th>Kind</th><th>Value</th><th>Annotation</th></tr></thead><tbody><tr><td>minLength</td><td>1</td><td></td></tr><tr><td>maxLength</td><td>45</td><td></td></tr><tr><td>pattern</td><td>\S*.[\p(L)].*</td><td></td></tr></tbody></table>	Kind	Value	Annotation	minLength	1		maxLength	45		pattern	\S*.[\p(L)].*	
Kind	Value	Annotation											
minLength	1												
maxLength	45												
pattern	\S*.[\p(L)].*												
annotation	documentation SDL02: Name des Leistungserbringers												
source	<pre><xs:element name="Name" type="Name_Stp"> <xs:annotation> <xs:documentation>SDL02: Name des Leistungserbringers</xs:documentation> </xs:annotation> </xs:element></pre>												

element Leistungserbringer_Ctp/Name_Geschaeft

diagram													
namespace	MD:/xml-schema/MD-basis/3.5												
type	Name_Stp												
properties	minOcc 0 maxOcc 1 content simple												
facets	<table border="1"> <thead> <tr> <th>Kind</th> <th>Value</th> <th>Annotation</th> </tr> </thead> <tbody> <tr> <td>minLength</td> <td>1</td> <td></td> </tr> <tr> <td>maxLength</td> <td>45</td> <td></td> </tr> <tr> <td>pattern</td> <td>\S*.[\p{L}].*</td> <td></td> </tr> </tbody> </table>	Kind	Value	Annotation	minLength	1		maxLength	45		pattern	\S*.[\p{L}].*	
Kind	Value	Annotation											
minLength	1												
maxLength	45												
pattern	\S*.[\p{L}].*												
annotation	documentation SDL03: Name des Geschäftes/ Standort												
source	<pre><xs:element name="Name_Geschaeft" type="Name_Stp" minOccurs="0"> <xs:annotation> <xs:documentation>SDL03: Name des Geschäftes/ Standort</xs:documentation> </xs:annotation> </xs:element></pre>												

element Leistungserbringer_Ctp/Adresse

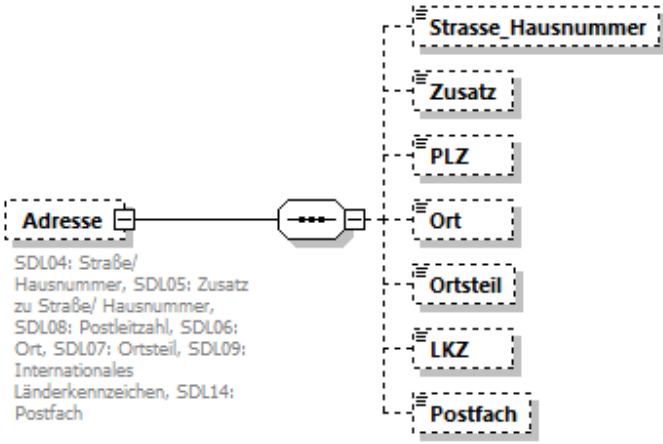
diagram	
namespace	MD:/xml-schema/MD-basis/3.5
type	restriction of Adresse_Ctp
properties	minOcc 0 maxOcc 1 content complex
children	Strasse_Hausnummer Zusatz PLZ Ort Ortsteil LKZ Postfach
annotation	documentation SDL04: Straße/ Hausnummer, SDL05: Zusatz zu Straße/ Hausnummer, SDL08: Postleitzahl, SDL06: Ort, SDL07: Ortsteil, SDL09: Internationales Länderkennzeichen, SDL14: Postfach
source	<pre><xs:element name="Adresse" minOccurs="0"></pre>

	<pre> <xs: annotation> <xs: documentation>SDL04: Straße/ Hausnummer, SDL05: Zusatz zu Straße/ Hausnummer, SDL08: Postleitzahl, SDL06: Ort, SDL07: Ortsteil, SDL09: Internationales Länderkennzeichen, SDL14: Postfach</xs: documentation> </xs: annotation> <xs: complexType> <xs: complexContent> <xs: restriction base="Adresse_Ctp"> <xs: sequence> <xs: element name="Strasse_Hausnummer" type="Strasse_Hausnummer_Stp" minOccurs="0"/> <xs: element name="Zusatz" type="Anschriftenzusatz_Stp" minOccurs="0"/> <xs: element name="PLZ" type="PLZ_Stp" minOccurs="0"/> <xs: element name="Ort" type="Ort_Stp" minOccurs="0"/> <xs: element name="Ortsteil" type="Ort_Stp" minOccurs="0"/> <xs: element name="LKZ" type="LKZ_Stp" minOccurs="0"/> <xs: element name="Postfach" type="Postfach_Stp" minOccurs="0"/> </xs: sequence> </xs: restriction> </xs: complexContent> </xs: complexType> </xs: element> </pre>
--	---

element Leistungserbringer_Ctp/Adresse/Strasse_Hausnummer

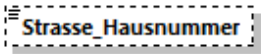
diagram													
namespace	MD:/xml-schema/MD-basis/3.5												
type	Strasse_Hausnummer_Stp												
properties	minOcc 0 maxOcc 1 content simple												
facets	<table border="1"> <thead> <tr> <th>Kind</th> <th>Value</th> <th>Annotation</th> </tr> </thead> <tbody> <tr> <td>minLength</td> <td>1</td> <td></td> </tr> <tr> <td>maxLength</td> <td>56</td> <td></td> </tr> <tr> <td>pattern</td> <td>\S*.[\p{L}].*</td> <td></td> </tr> </tbody> </table>	Kind	Value	Annotation	minLength	1		maxLength	56		pattern	\S*.[\p{L}].*	
Kind	Value	Annotation											
minLength	1												
maxLength	56												
pattern	\S*.[\p{L}].*												
source	<pre><xs: element name="Strasse_Hausnummer" type="Strasse_Hausnummer_Stp" minOccurs="0"/></pre>												

element Leistungserbringer_Ctp/Adresse/Zusatz

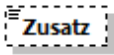
diagram	
namespace	MD:/xml-schema/MD-basis/3.5
type	Anschriftenzusatz_Stp
properties	minOcc 0 maxOcc 1 content simple

facets	Kind	Value	Annotation
	minLength	1	
	maxLength	40	
	pattern	\S*.[\p{L}\p{N}].*	
source	<xs:element name="Zusatz" type="Anschri ftenzusatz_Stp" mi n0ccurs="0"/>		

element Leistungserbringer_Ctp/Adresse/PLZ

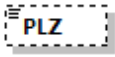
diagram			
namespace	MD:/xml-schema/MD-basis/3.5		
type	PLZ_Stp		
properties	minOcc	0	
	maxOcc	1	
	content	simple	
facets	Kind	Value	Annotation
	minLength	1	
	maxLength	10	
	pattern	\S*.[\p{L}\p{N}+].*	
source	<xs:element name="PLZ" type="PLZ_Stp" mi n0ccurs="0"/>		

element Leistungserbringer_Ctp/Adresse/Ort

diagram			
namespace	MD:/xml-schema/MD-basis/3.5		
type	Ort_Stp		
properties	minOcc	0	
	maxOcc	1	
	content	simple	
facets	Kind	Value	Annotation
	minLength	1	
	maxLength	40	
	pattern	\S*.[\p{L}].*	
source	<xs:element name="Ort" type="Ort_Stp" mi n0ccurs="0"/>		

element Leistungserbringer_Ctp/Adresse/Ortsteil

diagram			
namespace	MD:/xml-schema/MD-basis/3.5		
type	Ort_Stp		
properties	minOcc	0	
	maxOcc	1	

	content simple												
facets	<table border="1"> <thead> <tr> <th>Kind</th> <th>Value</th> <th>Annotation</th> </tr> </thead> <tbody> <tr> <td>minLength</td> <td>1</td> <td></td> </tr> <tr> <td>maxLength</td> <td>40</td> <td></td> </tr> <tr> <td>pattern</td> <td>\S*.[\p{L}].*</td> <td></td> </tr> </tbody> </table>	Kind	Value	Annotation	minLength	1		maxLength	40		pattern	\S*.[\p{L}].*	
Kind	Value	Annotation											
minLength	1												
maxLength	40												
pattern	\S*.[\p{L}].*												
source	<xs:element name="Ortsteil" type="Ort_Stp" minOccurs="0"/>												

element Leistungserbringer_Ctp/Adresse/LKZ

diagram													
namespace	MD:/xml-schema/MD-basis/3.5												
type	LKZ_Stp												
properties	<table border="1"> <tbody> <tr> <td>minOcc</td> <td>0</td> </tr> <tr> <td>maxOcc</td> <td>1</td> </tr> <tr> <td>content</td> <td>simple</td> </tr> </tbody> </table>	minOcc	0	maxOcc	1	content	simple						
minOcc	0												
maxOcc	1												
content	simple												
facets	<table border="1"> <thead> <tr> <th>Kind</th> <th>Value</th> <th>Annotation</th> </tr> </thead> <tbody> <tr> <td>minLength</td> <td>1</td> <td></td> </tr> <tr> <td>maxLength</td> <td>3</td> <td></td> </tr> <tr> <td>pattern</td> <td>[A-Z]+</td> <td></td> </tr> </tbody> </table>	Kind	Value	Annotation	minLength	1		maxLength	3		pattern	[A-Z]+	
Kind	Value	Annotation											
minLength	1												
maxLength	3												
pattern	[A-Z]+												
source	<xs:element name="LKZ" type="LKZ_Stp" minOccurs="0"/>												

element Leistungserbringer_Ctp/Adresse/Postfach

diagram													
namespace	MD:/xml-schema/MD-basis/3.5												
type	Postfach_Stp												
properties	<table border="1"> <tbody> <tr> <td>minOcc</td> <td>0</td> </tr> <tr> <td>maxOcc</td> <td>1</td> </tr> <tr> <td>content</td> <td>simple</td> </tr> </tbody> </table>	minOcc	0	maxOcc	1	content	simple						
minOcc	0												
maxOcc	1												
content	simple												
facets	<table border="1"> <thead> <tr> <th>Kind</th> <th>Value</th> <th>Annotation</th> </tr> </thead> <tbody> <tr> <td>minLength</td> <td>1</td> <td></td> </tr> <tr> <td>maxLength</td> <td>45</td> <td></td> </tr> <tr> <td>pattern</td> <td>\S+ [&#x0020;-&#x00FF;]*</td> <td></td> </tr> </tbody> </table>	Kind	Value	Annotation	minLength	1		maxLength	45		pattern	\S+ [-ÿ]*	
Kind	Value	Annotation											
minLength	1												
maxLength	45												
pattern	\S+ [-ÿ]*												
source	<xs:element name="Postfach" type="Postfach_Stp" minOccurs="0"/>												

element Leistungserbringer_Ctp/Kontakt

diagram	
namespace	MD:/xml-schema/MD-basis/3.5
type	restriction of Kontaktdaten_Ctp
properties	minOcc 0 maxOcc 1 content complex
children	Telefon Telefax Mobiltelefon Email
annotation	documentation SDL10: Telefon, SDL11: Telefax, SDL12: Mobiltelefon, SDL13: Email
source	<pre><xs:element name="Kontakt" minOccurs="0"> <xs:annotation> <xs:documentation>SDL10: Telefon, SDL11: Telefax, SDL12: Mobiltelefon, SDL13: Email</xs:documentation> </xs:annotation> <xs:complexType> <xs:complexContent> <xs:restriction base="Kontaktdaten_Ctp"> <xs:sequence> <xs:element name="Telefon" type="Telefon_Stp" minOccurs="0"/> <xs:element name="Telefax" type="Telefax_Stp" minOccurs="0"/> <xs:element name="Mobiltelefon" type="Mobiltelefon_Stp" minOccurs="0"/> <xs:element name="Email" type="Email_Stp" minOccurs="0"/> </xs:sequence> </xs:restriction> </xs:complexContent> </xs:complexType> </xs:element></pre>

element Leistungserbringer_Ctp/Kontakt/Telefon

diagram										
namespace	MD:/xml-schema/MD-basis/3.5									
type	Telefon_Stp									
properties	minOcc 0 maxOcc 1 content simple									
facets	<table border="1"> <thead> <tr> <th>Kind</th> <th>Value</th> <th>Annotation</th> </tr> </thead> <tbody> <tr> <td>minLength</td> <td>1</td> <td></td> </tr> <tr> <td>maxLength</td> <td>20</td> <td></td> </tr> </tbody> </table>	Kind	Value	Annotation	minLength	1		maxLength	20	
Kind	Value	Annotation								
minLength	1									
maxLength	20									

	pattern \S*.[\p{L}\p{N}].*
source	<xs:element name="Telefon" type="Telefon_Stp" minOccurs="0"/>

element Leistungserbringer_Ctp/Kontakt/Telefax

diagram	
namespace	MD/xml-schema/MD-basis/3.5
type	Telefax_Stp
properties	minOcc 0 maxOcc 1 content simple
facets	Kind Value Annotation minLength 1 maxLength 20 pattern \S*.[\p{L}\p{N}].*
source	<xs:element name="Telefax" type="Telefax_Stp" minOccurs="0"/>

element Leistungserbringer_Ctp/Kontakt/Mobiltelefon

diagram	
namespace	MD/xml-schema/MD-basis/3.5
type	Mobiltelefon_Stp
properties	minOcc 0 maxOcc 1 content simple
facets	Kind Value Annotation minLength 1 maxLength 20 pattern \S*.[\p{L}\p{N}].*
source	<xs:element name="Mobiltelefon" type="Mobiltelefon_Stp" minOccurs="0"/>

element Leistungserbringer_Ctp/Kontakt/Email

diagram	
namespace	MD/xml-schema/MD-basis/3.5
type	Email_Stp
properties	minOcc 0 maxOcc 1 content simple
facets	Kind Value Annotation minLength 1

	maxLength 50 pattern [_\-\a-zA-Z0-9\.\+\@\[a-zA-Z0-9](\.[\-\a-zA-Z0-9]*[a-zA-Z0-9])*
source	<xs:element name="Email" type="Email_Stp" minOccurs="0"/>

complexType MD_Ctp

diagram	
namespace	MD:/xml-schema/MD-basis/3.5
children	IK Beratungsstelle Adresse Ansprechpartner Kontakt
used by	element Begutachtung/MD
annotation	documentation GSM: Stammdaten MD
source	<pre> <xs:complexType name="MD_Ctp"> <xs:annotation> <xs:documentation>GSM: Stammdaten MD</xs:documentation> </xs:annotation> <xs:sequence> <xs:element name="IK" type="IK_Stp"> <xs:annotation> <xs:documentation>GSM01: IK des MD</xs:documentation> </xs:annotation> </xs:element> <xs:element name="Beratungsstelle" type="Beratungsstelle_MD_Ctp"> <xs:annotation> <xs:documentation>Nummer und Name der Beratungsstelle</xs:documentation> </xs:annotation> </xs:element> <xs:element name="Adresse" minOccurs="0"> </pre>

```

<xs:annotation>
  <xs:documentation>GSM04: Straße/ Hausnummer, GSM12: Zusatz zu Straße/
Hausnummer, GSM05: Postleitzahl, GSM06: Ort, GSM11: Ortsteil</xs:documentation>
</xs:annotation>
<xs:complexType>
  <xs:complexContent>
    <xs:restriction base="Adresse_Ctp">
      <xs:sequence>
        <xs:element name="Strasse_Hausnummer" type="Strasse_Hausnummer_Stp"
minOccurs="0"/>
        <xs:element name="Zusatz" type="Anschri ftenzusatz_Stp"
minOccurs="0"/>
        <xs:element name="PLZ" type="PLZ_Stp" minOccurs="0"/>
        <xs:element name="Ort" type="Ort_Stp" minOccurs="0"/>
        <xs:element name="Ortsteil" type="Ort_Stp" minOccurs="0"/>
        <xs:element name="LKZ" type="LKZ_Stp" minOccurs="0" maxOccurs="0"/>
        <xs:element name="Postfach" type="Postfach_Stp" minOccurs="0"
maxOccurs="0"/>
      </xs:sequence>
    </xs:restriction>
  </xs:complexContent>
</xs:complexType>
</xs:element>
<xs:element name="Ansprechpartner" type="Sachbearbei ter_Orga_Stp">
  <xs:annotation>
    <xs:documentation>GSM07: Ansprechpartner</xs:documentation>
  </xs:annotation>
</xs:element>
<xs:element name="Kontakt">
  <xs:annotation>
    <xs:documentation>GSM08: Telefon Ansprechpartner, GSM09: Telefax
Ansprechpartner, GSM10: E-Mail -Adresse Ansprechpartner</xs:documentation>
  </xs:annotation>
  <xs:complexType>
    <xs:complexContent>
      <xs:restriction base="Kontakt daten_Ctp">
        <xs:sequence>
          <xs:element name="Tel efon" type="Tel efon_Stp"/>
          <xs:element name="Tel efax" type="Tel efax_Stp" minOccurs="0"/>
          <xs:element name="Mobi l tel efon" type="Mobi l tel efon_Stp"
minOccurs="0" maxOccurs="0"/>
          <xs:element name="Emai l" type="Emai l_Stp" minOccurs="0"/>
        </xs:sequence>
      </xs:restriction>
    </xs:complexContent>
  </xs:complexType>
</xs:element>
</xs:sequence>
</xs:complexType>

```

element MD_Ctp/IK

diagram													
namespace	MD:/xml-schema/MD-basis/3.5												
type	IK_Stp												
properties	content simple												
facets	<table border="1"> <thead> <tr> <th>Kind</th> <th>Value</th> <th>Annotation</th> </tr> </thead> <tbody> <tr> <td>minLength</td> <td>9</td> <td></td> </tr> <tr> <td>maxLength</td> <td>9</td> <td></td> </tr> <tr> <td>pattern</td> <td>[1-9][0-9]+</td> <td></td> </tr> </tbody> </table>	Kind	Value	Annotation	minLength	9		maxLength	9		pattern	[1-9][0-9]+	
Kind	Value	Annotation											
minLength	9												
maxLength	9												
pattern	[1-9][0-9]+												
annotation	documentation GSM01: IK des MD												
source	<pre><xs:element name="IK" type="IK_Stp"> <xs:annotation> <xs:documentation>GSM01: IK des MD</xs:documentation> </xs:annotation> </xs:element></pre>												

element MD_Ctp/Beratungsstelle

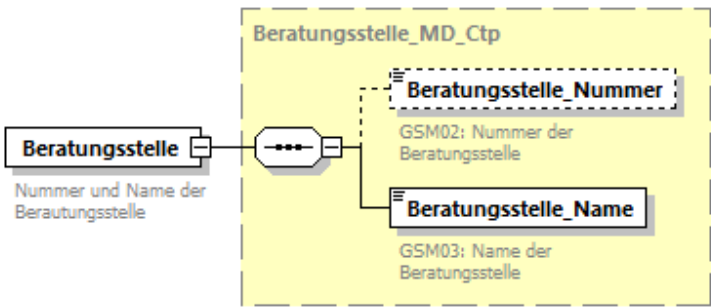
diagram	
namespace	MD:/xml-schema/MD-basis/3.5
type	Beratungsstelle_MD_Ctp
properties	content complex
children	Beratungsstelle_Nummer Beratungsstelle_Name
annotation	documentation Nummer und Name der Beratungsstelle
source	<pre><xs:element name="Beratungsstelle" type="Beratungsstelle_MD_Ctp"> <xs:annotation> <xs:documentation>Nummer und Name der Beratungsstelle</xs:documentation> </xs:annotation> </xs:element></pre>

element MD_Ctp/Adresse

<p>diagram</p>	
<p>namespace</p>	<p>MD:/xml-schema/MD-basis/3.5</p>
<p>type</p>	<p>restriction of Adresse_Ctp</p>
<p>properties</p>	<p>minOcc 0 maxOcc 1 content complex</p>
<p>children</p>	<p>Strasse_Hausnummer Zusatz PLZ Ort Ortsteil Lkz Postfach</p>
<p>annotation</p>	<p>documentation GSM04: Straße/ Hausnummer, GSM12: Zusatz zu Straße/ Hausnummer, GSM05: Postleitzahl, GSM06: Ort, GSM11: Ortsteil</p>
<p>source</p>	<pre><xs:element name="Adresse" minOccurs="0"> <xs:annotation> <xs:documentation>GSM04: Straße/ Hausnummer, GSM12: Zusatz zu Straße/ Hausnummer, GSM05: Postleitzahl, GSM06: Ort, GSM11: Ortsteil</xs:documentation> </xs:annotation> <xs:complexType> <xs:complexContent> <xs:restriction base="Adresse_Ctp"> <xs:sequence> <xs:element name="Strasse_Hausnummer" type="Strasse_Hausnummer_Stp" minOccurs="0"/> <xs:element name="Zusatz" type="Anschri ftenzusatz_Stp" minOccurs="0"/> <xs:element name="PLZ" type="PLZ_Stp" minOccurs="0"/> <xs:element name="Ort" type="Ort_Stp" minOccurs="0"/> <xs:element name="Ortsteil" type="Ort_Stp" minOccurs="0"/> <xs:element name="Lkz" type="Lkz_Stp" minOccurs="0" maxOccurs="0"/> <xs:element name="Postfach" type="Postfach_Stp" minOccurs="0" maxOccurs="0"/> </xs:sequence> </xs:restriction> </xs:complexContent> </xs:complexType> </xs:element></pre>

element MD_Ctp/Adresse/Strasse_Hausnummer

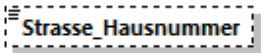
diagram	
namespace	MD:/xml-schema/MD-basis/3.5
type	Strasse_Hausnummer_Stp
properties	minOcc 0 maxOcc 1 content simple
facets	Kind Value Annotation minLength 1 maxLength 56 pattern \S*.[\p{L}].*
source	<xs:element name="Strasse_Hausnummer" type="Strasse_Hausnummer_Stp" minOccurs="0" />

element MD_Ctp/Adresse/Zusatz

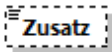
diagram	
namespace	MD:/xml-schema/MD-basis/3.5
type	Anschriftenzusatz_Stp
properties	minOcc 0 maxOcc 1 content simple
facets	Kind Value Annotation minLength 1 maxLength 40 pattern \S*.[\p{L}\p{N}].*
source	<xs:element name="Zusatz" type="Anschriftenzusatz_Stp" minOccurs="0" />

element MD_Ctp/Adresse/PLZ

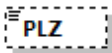
diagram	
namespace	MD:/xml-schema/MD-basis/3.5
type	PLZ_Stp
properties	minOcc 0 maxOcc 1 content simple
facets	Kind Value Annotation minLength 1 maxLength 10 pattern \S*.[\p{L}\p{N}+].*
source	<xs:element name="PLZ" type="PLZ_Stp" minOccurs="0" />

element MD_Ctp/Adresse/Ort

diagram													
namespace	MD:/xml-schema/MD-basis/3.5												
type	Ort_Stp												
properties	minOcc 0 maxOcc 1 content simple												
facets	<table border="1"> <thead> <tr> <th>Kind</th> <th>Value</th> <th>Annotation</th> </tr> </thead> <tbody> <tr> <td>minLength</td> <td>1</td> <td></td> </tr> <tr> <td>maxLength</td> <td>40</td> <td></td> </tr> <tr> <td>pattern</td> <td>\S*.*[\p{L}].*</td> <td></td> </tr> </tbody> </table>	Kind	Value	Annotation	minLength	1		maxLength	40		pattern	\S*.*[\p{L}].*	
Kind	Value	Annotation											
minLength	1												
maxLength	40												
pattern	\S*.*[\p{L}].*												
source	<xs:element name="Ort" type="Ort_Stp" minOccurs="0"/>												

element MD_Ctp/Adresse/Ortsteil

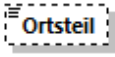
diagram													
namespace	MD:/xml-schema/MD-basis/3.5												
type	Ort_Stp												
properties	minOcc 0 maxOcc 1 content simple												
facets	<table border="1"> <thead> <tr> <th>Kind</th> <th>Value</th> <th>Annotation</th> </tr> </thead> <tbody> <tr> <td>minLength</td> <td>1</td> <td></td> </tr> <tr> <td>maxLength</td> <td>40</td> <td></td> </tr> <tr> <td>pattern</td> <td>\S*.*[\p{L}].*</td> <td></td> </tr> </tbody> </table>	Kind	Value	Annotation	minLength	1		maxLength	40		pattern	\S*.*[\p{L}].*	
Kind	Value	Annotation											
minLength	1												
maxLength	40												
pattern	\S*.*[\p{L}].*												
source	<xs:element name="Ortsteil" type="Ort_Stp" minOccurs="0"/>												

element MD_Ctp/Adresse/LKZ

diagram													
namespace	MD:/xml-schema/MD-basis/3.5												
type	LKZ_Stp												
properties	minOcc 0 maxOcc 0 content simple												
facets	<table border="1"> <thead> <tr> <th>Kind</th> <th>Value</th> <th>Annotation</th> </tr> </thead> <tbody> <tr> <td>minLength</td> <td>1</td> <td></td> </tr> <tr> <td>maxLength</td> <td>3</td> <td></td> </tr> <tr> <td>pattern</td> <td>[A-Z]+</td> <td></td> </tr> </tbody> </table>	Kind	Value	Annotation	minLength	1		maxLength	3		pattern	[A-Z]+	
Kind	Value	Annotation											
minLength	1												
maxLength	3												
pattern	[A-Z]+												

source	<code><xs:element name="LKZ" type="LKZ_Stp" minOccurs="0" maxOccurs="0"/></code>
--------	--

element MD_Ctp/Adresse/Postfach

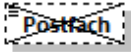
diagram													
namespace	MD:/xml-schema/MD-basis/3.5												
type	Postfach_Stp												
properties	minOcc 0 maxOcc 0 content simple												
facets	<table border="1"> <thead> <tr> <th>Kind</th> <th>Value</th> <th>Annotation</th> </tr> </thead> <tbody> <tr> <td>minLength</td> <td>1</td> <td></td> </tr> <tr> <td>maxLength</td> <td>45</td> <td></td> </tr> <tr> <td>pattern</td> <td>\S+ [&#x0020;-&#x00FF;]*</td> <td></td> </tr> </tbody> </table>	Kind	Value	Annotation	minLength	1		maxLength	45		pattern	\S+ [-ÿ]*	
Kind	Value	Annotation											
minLength	1												
maxLength	45												
pattern	\S+ [-ÿ]*												
source	<code><xs:element name="Postfach" type="Postfach_Stp" minOccurs="0" maxOccurs="0"/></code>												

element MD_Ctp/Ansprechpartner

diagram													
namespace	MD:/xml-schema/MD-basis/3.5												
type	Sachbearbeiter_Orga_Stp												
properties	content simple												
facets	<table border="1"> <thead> <tr> <th>Kind</th> <th>Value</th> <th>Annotation</th> </tr> </thead> <tbody> <tr> <td>minLength</td> <td>2</td> <td></td> </tr> <tr> <td>maxLength</td> <td>30</td> <td></td> </tr> <tr> <td>pattern</td> <td>\S+ [&#x0020;-&#x00FF;]*</td> <td></td> </tr> </tbody> </table>	Kind	Value	Annotation	minLength	2		maxLength	30		pattern	\S+ [-ÿ]*	
Kind	Value	Annotation											
minLength	2												
maxLength	30												
pattern	\S+ [-ÿ]*												
annotation	documentation GSM07: Ansprechpartner												
source	<code><xs:element name="Ansprechpartner" type="Sachbearbeiter_Orga_Stp"> <xs:annotation> <xs:documentation>GSM07: Ansprechpartner</xs:documentation> </xs:annotation> </xs:element></code>												

element MD_Ctp/Kontakt

diagram	
namespace	MD:/xml-schema/MD-basis/3.5
type	restriction of Kontaktdaten_Ctp
properties	content complex
children	Telefon Telefax Mobiltelefon Email
annotation	documentation GSM08: Telefon Ansprechpartner, GSM09: Telefax Ansprechpartner, GSM10: E-Mail-Adresse Ansprechpartner
source	<pre> <xs:element name="Kontakt"> <xs:annotation> <xs:documentation>GSM08: Telefon Ansprechpartner, GSM09: Telefax Ansprechpartner, GSM10: E-Mail-Adresse Ansprechpartner</xs:documentation> </xs:annotation> <xs:complexType> <xs:complexContent> <xs:restriction base="Kontaktdaten_Ctp"> <xs:sequence> <xs:element name="Telefon" type="Telefon_Stp"/> <xs:element name="Telefax" type="Telefax_Stp" minOccurs="0"/> <xs:element name="Mobiltelefon" type="Mobiltelefon_Stp" minOccurs="0" maxOccurs="0"/> <xs:element name="Email" type="Email_Stp" minOccurs="0"/> </xs:sequence> </xs:restriction> </xs:complexContent> </xs:complexType> </xs:element> </pre>

element MD_Ctp/Kontakt/Telefon

diagram													
namespace	MD:/xml-schema/MD-basis/3.5												
type	Telefon_Stp												
properties	content simple												
facets	<table border="1"> <thead> <tr> <th>Kind</th> <th>Value</th> <th>Annotation</th> </tr> </thead> <tbody> <tr> <td>minLength</td> <td>1</td> <td></td> </tr> <tr> <td>maxLength</td> <td>20</td> <td></td> </tr> <tr> <td>pattern</td> <td>\S*.*[\p{L}\p{N}].*</td> <td></td> </tr> </tbody> </table>	Kind	Value	Annotation	minLength	1		maxLength	20		pattern	\S*.*[\p{L}\p{N}].*	
Kind	Value	Annotation											
minLength	1												
maxLength	20												
pattern	\S*.*[\p{L}\p{N}].*												

source	<code><xs:element name="Telefon" type="Telefon_Stp"/></code>
--------	--

element MD_Ctp/Kontakt/Telefax

diagram	
namespace	MD:/xml-schema/MD-basis/3.5
type	Telefax_Stp
properties	minOcc 0 maxOcc 1 content simple
facets	Kind Value Annotation minLength 1 maxLength 20 pattern \S*.[\p{L}\p{N}].*
source	<code><xs:element name="Telefax" type="Telefax_Stp" minOccurs="0"/></code>

element MD_Ctp/Kontakt/Mobiltelefon

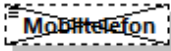
diagram	
namespace	MD:/xml-schema/MD-basis/3.5
type	Mobiltelefon_Stp
properties	minOcc 0 maxOcc 0 content simple
facets	Kind Value Annotation minLength 1 maxLength 20 pattern \S*.[\p{L}\p{N}].*
source	<code><xs:element name="Mobiltelefon" type="Mobiltelefon_Stp" minOccurs="0" maxOccurs="0"/></code>

element MD_Ctp/Kontakt/Email

diagram	
namespace	MD:/xml-schema/MD-basis/3.5
type	Email_Stp
properties	minOcc 0 maxOcc 1 content simple
facets	Kind Value Annotation minLength 1

	maxLength 50 pattern [_\-\a-zA-Z0-9\.\+\]+\@[a-zA-Z0-9](\.[\-\a-zA-Z0-9]*[a-zA-Z0-9])*
source	<xs:element name="Email" type="Email_Stp" minOccurs="0"/>

complexType Nebenstelle_Kasse_Ctp

diagram	
namespace	MD:/xml-schema/MD-basis/3.5
children	Nebenstelle_Nummer Nebenstelle_Name
used by	element Kasse_Ctp/Nebenstelle
annotation	documentation Nebenstelle der Kasse
source	<pre> <xs:complexType name="Nebenstelle_Kasse_Ctp"> <xs:annotation> <xs:documentation>Nebenstelle der Kasse</xs:documentation> </xs:annotation> <xs:sequence> <xs:element name="Nebenstelle_Nummer" type="Nebenstellenummer_Stp" minOccurs="0"> <xs:annotation> <xs:documentation>ASK02: Nummer der Nebenstelle</xs:documentation> </xs:annotation> </xs:element> <xs:element name="Nebenstelle_Name" type="Name_Stp" minOccurs="0"> <xs:annotation> <xs:documentation>ASK04: Name der Nebenstelle/Betreuungsstelle</xs:documentation> </xs:annotation> </xs:element> </xs:sequence> </xs:complexType> </pre>

element Nebenstelle_Kasse_Ctp/Nebenstelle_Nummer

diagram	
namespace	MD:/xml-schema/MD-basis/3.5
type	Nebenstellenummer_Stp
properties	minOcc 0

	maxOcc 1 content simple
facets	Kind Value Annotation minLength 1 maxLength 5 pattern \S+ [-ÿ]*
annotation	documentation ASK02: Nummer der Nebenstelle
source	<xs:element name="Nebenstelle_Nummer" type="Nebenstellennummer_Stp" minOccurs="0"> <xs:annotation> <xs:documentation>ASK02: Nummer der Nebenstelle</xs:documentation> </xs:annotation> </xs:element>

element Nebenstelle_Kasse_Ctp/Nebenstelle_Name

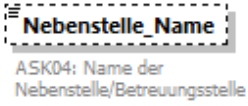
diagram	
namespace	MD:/xml-schema/MD-basis/3.5
type	Name_Stp
properties	minOcc 0 maxOcc 1 content simple
facets	Kind Value Annotation minLength 1 maxLength 45 pattern \S*.*[\p{L}].*
annotation	documentation ASK04: Name der Nebenstelle/Betreuungsstelle
source	<xs:element name="Nebenstelle_Name" type="Name_Stp" minOccurs="0"> <xs:annotation> <xs:documentation>ASK04: Name der Nebenstelle/Betreuungsstelle</xs:documentation> </xs:annotation> </xs:element>

complexType Person_Ctp

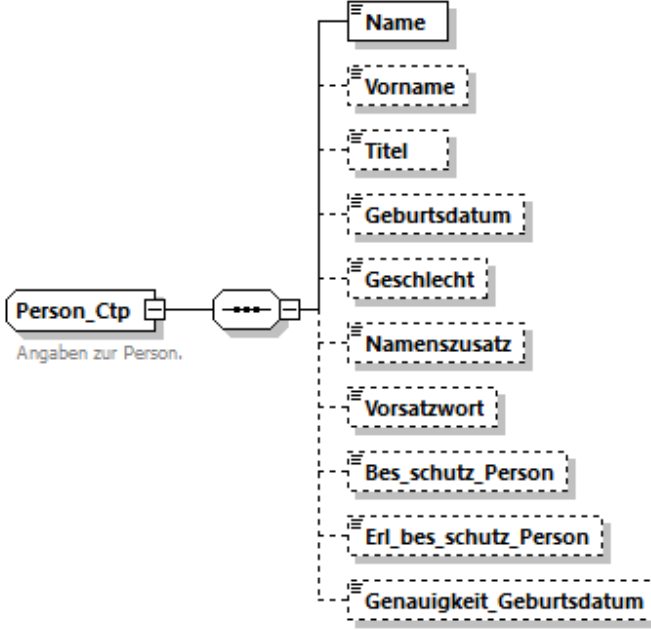
<p>diagram</p>	
<p>namespace</p>	<p>MD:/xml-schema/MD-basis/3.5</p>
<p>children</p>	<p>Name Vorname Titel Geburtsdatum Geschlecht Namenszusatz Vorsatzwort Bes_schutz_Person Erl_bes_schutz_Person Genauigkeit_Geburtsdatum</p>
<p>used by</p>	<p>elements Adressat_Oder_Adresse_Ctp/Person Arzt_Ctp/Person Versicherter_Ctp/Person</p>
<p>annotation</p>	<p>documentation Angaben zur Person.</p>
<p>source</p>	<pre><xs:complexType name="Person_Ctp"> <xs:annotation> <xs:documentation>Angaben zur Person.</xs:documentation> </xs:annotation> <xs:sequence> <xs:element name="Name" type="Name_Stp"/> <xs:element name="Vorname" type="Name_Stp" minOccurs="0"/> <xs:element name="Titel" type="Titel_Stp" minOccurs="0"/> <xs:element name="Geburtsdatum" type="Datum_Stp" minOccurs="0"/> <xs:element name="Geschlecht" type="Geschlecht_Stp" minOccurs="0"/> <xs:element name="Namenszusatz" type="Namenszusatz_Stp" minOccurs="0"/> <xs:element name="Vorsatzwort" type="Vorsatzwort_Stp" minOccurs="0"/> <xs:element name="Bes_schutz_Person" type="Bes_schutz_Person_Stp" minOccurs="0"/> <xs:element name="Erl_bes_schutz_Person" type="Frei text_Mit_Zeilenum_1000_Stp" minOccurs="0"/> <xs:element name="Genauigkeit_Geburtsdatum" type="Gen_Geburtsdatum_Stp" minOccurs="0"/> </xs:sequence> </xs:complexType></pre>

element Person_Ctp/Name

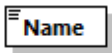
diagram													
namespace	MD:/xml-schema/MD-basis/3.5												
type	Name_Stp												
properties	content simple												
facets	<table border="1"> <thead> <tr> <th>Kind</th> <th>Value</th> <th>Annotation</th> </tr> </thead> <tbody> <tr> <td>minLength</td> <td>1</td> <td></td> </tr> <tr> <td>maxLength</td> <td>45</td> <td></td> </tr> <tr> <td>pattern</td> <td>\S*.[\p{L}].*</td> <td></td> </tr> </tbody> </table>	Kind	Value	Annotation	minLength	1		maxLength	45		pattern	\S*.[\p{L}].*	
Kind	Value	Annotation											
minLength	1												
maxLength	45												
pattern	\S*.[\p{L}].*												
source	<xs:element name="Name" type="Name_Stp"/>												

element Person_Ctp/Vorname

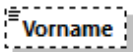
diagram													
namespace	MD:/xml-schema/MD-basis/3.5												
type	Name_Stp												
properties	<table border="1"> <tbody> <tr> <td>minOcc</td> <td>0</td> </tr> <tr> <td>maxOcc</td> <td>1</td> </tr> <tr> <td>content</td> <td>simple</td> </tr> </tbody> </table>	minOcc	0	maxOcc	1	content	simple						
minOcc	0												
maxOcc	1												
content	simple												
facets	<table border="1"> <thead> <tr> <th>Kind</th> <th>Value</th> <th>Annotation</th> </tr> </thead> <tbody> <tr> <td>minLength</td> <td>1</td> <td></td> </tr> <tr> <td>maxLength</td> <td>45</td> <td></td> </tr> <tr> <td>pattern</td> <td>\S*.[\p{L}].*</td> <td></td> </tr> </tbody> </table>	Kind	Value	Annotation	minLength	1		maxLength	45		pattern	\S*.[\p{L}].*	
Kind	Value	Annotation											
minLength	1												
maxLength	45												
pattern	\S*.[\p{L}].*												
source	<xs:element name="Vorname" type="Name_Stp" minOccurs="0"/>												

element Person_Ctp/Titel

diagram													
namespace	MD:/xml-schema/MD-basis/3.5												
type	Titel_Stp												
properties	<table border="1"> <tbody> <tr> <td>minOcc</td> <td>0</td> </tr> <tr> <td>maxOcc</td> <td>1</td> </tr> <tr> <td>content</td> <td>simple</td> </tr> </tbody> </table>	minOcc	0	maxOcc	1	content	simple						
minOcc	0												
maxOcc	1												
content	simple												
facets	<table border="1"> <thead> <tr> <th>Kind</th> <th>Value</th> <th>Annotation</th> </tr> </thead> <tbody> <tr> <td>minLength</td> <td>1</td> <td></td> </tr> <tr> <td>maxLength</td> <td>20</td> <td></td> </tr> <tr> <td>pattern</td> <td>\S*.[\p{L}].*</td> <td></td> </tr> </tbody> </table>	Kind	Value	Annotation	minLength	1		maxLength	20		pattern	\S*.[\p{L}].*	
Kind	Value	Annotation											
minLength	1												
maxLength	20												
pattern	\S*.[\p{L}].*												
source	<xs:element name="Titel" type="Titel_Stp" minOccurs="0"/>												

element Person_Ctp/Geburtsdatum

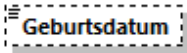
diagram										
namespace	MD/xml-schema/MD-basis/3.5									
type	Datum_Stp									
properties	minOcc 0 maxOcc 1 content simple									
facets	<table border="1"> <thead> <tr> <th>Kind</th> <th>Value</th> <th>Annotation</th> </tr> </thead> <tbody> <tr> <td>minInclusive</td> <td>1850-01-01</td> <td></td> </tr> <tr> <td>maxInclusive</td> <td>2099-12-31</td> <td></td> </tr> </tbody> </table>	Kind	Value	Annotation	minInclusive	1850-01-01		maxInclusive	2099-12-31	
Kind	Value	Annotation								
minInclusive	1850-01-01									
maxInclusive	2099-12-31									
source	<code><xs:element name="Geburtsdatum" type="Datum_Stp" minOccurs="0"/></code>									

element Person_Ctp/Geschlecht

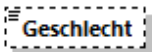
diagram																
namespace	MD/xml-schema/MD-basis/3.5															
type	Geschlecht_Stp															
properties	minOcc 0 maxOcc 1 content simple															
facets	<table border="1"> <thead> <tr> <th>Kind</th> <th>Value</th> <th>Annotation</th> </tr> </thead> <tbody> <tr> <td>enumeration</td> <td>m</td> <td></td> </tr> <tr> <td>enumeration</td> <td>w</td> <td></td> </tr> <tr> <td>enumeration</td> <td>x</td> <td></td> </tr> <tr> <td>enumeration</td> <td>d</td> <td></td> </tr> </tbody> </table>	Kind	Value	Annotation	enumeration	m		enumeration	w		enumeration	x		enumeration	d	
Kind	Value	Annotation														
enumeration	m															
enumeration	w															
enumeration	x															
enumeration	d															
source	<code><xs:element name="Geschlecht" type="Geschlecht_Stp" minOccurs="0"/></code>															

element Person_Ctp/Namenszusatz

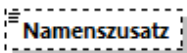
diagram													
namespace	MD/xml-schema/MD-basis/3.5												
type	Namenszusatz_Stp												
properties	minOcc 0 maxOcc 1 content simple												
facets	<table border="1"> <thead> <tr> <th>Kind</th> <th>Value</th> <th>Annotation</th> </tr> </thead> <tbody> <tr> <td>minLength</td> <td>1</td> <td></td> </tr> <tr> <td>maxLength</td> <td>20</td> <td></td> </tr> <tr> <td>pattern</td> <td>\S*[\p{L}].*</td> <td></td> </tr> </tbody> </table>	Kind	Value	Annotation	minLength	1		maxLength	20		pattern	\S*[\p{L}].*	
Kind	Value	Annotation											
minLength	1												
maxLength	20												
pattern	\S*[\p{L}].*												
source	<code><xs:element name="Namenszusatz" type="Namenszusatz_Stp" minOccurs="0"/></code>												

element Person_Ctp/Vorsatzwort

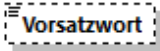
diagram	
namespace	MD:/xml-schema/MD-basis/3.5
type	Vorsatzwort_Stp
properties	minOcc 0 maxOcc 1 content simple
facets	Kind Value Annotation minLength 1 maxLength 20 pattern \S*.[\p{L}].*
source	<xs:element name="Vorsatzwort" type="Vorsatzwort_Stp" minOccurs="0"/>

element Person_Ctp/Bes_schutz_Person

diagram	
namespace	MD:/xml-schema/MD-basis/3.5
type	Bes_schutz_Person_Stp
properties	minOcc 0 maxOcc 1 content simple
facets	Kind Value Annotation enumeration 1 enumeration 2
source	<xs:element name="Bes_schutz_Person" type="Bes_schutz_Person_Stp" minOccurs="0"/>

element Person_Ctp/Erl_bes_schutz_Person

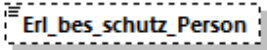
diagram	
namespace	MD:/xml-schema/MD-basis/3.5
type	Freitext Mit Zeilenum 1000_Stp
properties	minOcc 0 maxOcc 1 content simple
facets	Kind Value Annotation maxLength 1000 pattern \S+[\n\r\t -ÿ]*
source	<xs:element name="Erl_bes_schutz_Person" type="Freitext_Mi t_Zei lenum_1000_Stp" minOccurs="0"/>

element Person_Ctp/Genauigkeit_Geburtsdatum

diagram	
namespace	MD:/xml-schema/MD-basis/3.5
type	Gen_Geburtsdatum_Stp
properties	minOcc 0 maxOcc 1 content simple
facets	Kind Value Annotation enumeration 1 enumeration 2
source	<code><xs:element name="Genauigkeit_Geburtsdatum" type="Gen_Geburtsdatum_Stp" minOccurs="0"/></code>

complexType SFB_Standort_Ctp

diagram	
namespace	MD:/xml-schema/MD-basis/3.5
children	Name Strasse_Hausnummer PLZ Ort
used by	element Kasse_Ctp/SFB_Standort
annotation	documentation Name und Adresse des SFB-Standortes
source	<code><xs:complexType name="SFB_Standort_Ctp"> <xs:annotation> <xs:documentation>Name und Adresse des SFB-Standortes</xs:documentation> </xs:annotation> <xs:sequence> <xs:element name="Name" type="Name_Stp" minOccurs="0"> <xs:annotation> <xs:documentation>ASK15: SFB-Standort, Name</xs:documentation> </xs:annotation> </xs:element> <xs:element name="Strasse_Hausnummer" type="Strasse_Hausnummer_Stp"</code>

	<pre> mi nOccurs="0"> <xs: annotation> <xs: documentati on>ASK16: SFB-Standort, Straße/Hausnummer</xs: documentati on> </xs: annotation> </xs: el ement> <xs: el ement name="PLZ" type="PLZ_Stp" mi nOccurs="0"> <xs: annotation> <xs: documentati on>ASK17: SFB-Standort, Postlei tzahl</xs: documentati on> </xs: annotation> </xs: el ement> <xs: el ement name="Ort" type="Ort_Stp" mi nOccurs="0"> <xs: annotation> <xs: documentati on>ASK18: SFB-Standort, Ort</xs: documentati on> </xs: annotation> </xs: el ement> </xs: sequence> </xs: compl exType> </pre>
--	--

element SFB_Standort_Ctp/Name

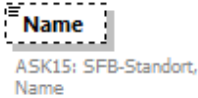
diagram	
namespace	MD:/xml-schema/MD-basis/3.5
type	Name_Stp
properties	minOcc 0 maxOcc 1 content simple
facets	Kind Value Annotation minLength 1 maxLength 45 pattern \S*.[\p{L}].*
annotation	documentation ASK15: SFB-Standort, Name
source	<pre> <xs: el ement name="Name" type="Name_Stp" mi nOccurs="0"> <xs: annotation> <xs: documentati on>ASK15: SFB-Standort, Name</xs: documentati on> </xs: annotation> </xs: el ement> </pre>

element SFB_Standort_Ctp/Strasse_Hausnummer

diagram	
namespace	MD:/xml-schema/MD-basis/3.5

type	Strasse_Hausnummer_Stp												
properties	minOcc 0 maxOcc 1 content simple												
facets	<table border="1"> <thead> <tr> <th>Kind</th> <th>Value</th> <th>Annotation</th> </tr> </thead> <tbody> <tr> <td>minLength</td> <td>1</td> <td></td> </tr> <tr> <td>maxLength</td> <td>56</td> <td></td> </tr> <tr> <td>pattern</td> <td>\S*.*[\p{L}].*</td> <td></td> </tr> </tbody> </table>	Kind	Value	Annotation	minLength	1		maxLength	56		pattern	\S*.*[\p{L}].*	
Kind	Value	Annotation											
minLength	1												
maxLength	56												
pattern	\S*.*[\p{L}].*												
annotation	documentation ASK16: SFB-Standort, Straße/Hausnummer												
source	<pre><xs:element name="Strasse_Hausnummer" type="Strasse_Hausnummer_Stp" minOccurs="0"> <xs:annotation> <xs:documentation>ASK16: SFB-Standort, Straße/Hausnummer</xs:documentation> </xs:annotation> </xs:element></pre>												

element SFB_Standort_Ctp/PLZ

diagram													
namespace	MD:/xml-schema/MD-basis/3.5												
type	PLZ_Stp												
properties	minOcc 0 maxOcc 1 content simple												
facets	<table border="1"> <thead> <tr> <th>Kind</th> <th>Value</th> <th>Annotation</th> </tr> </thead> <tbody> <tr> <td>minLength</td> <td>1</td> <td></td> </tr> <tr> <td>maxLength</td> <td>10</td> <td></td> </tr> <tr> <td>pattern</td> <td>\S*.*[\p{L}\p{N}+].*</td> <td></td> </tr> </tbody> </table>	Kind	Value	Annotation	minLength	1		maxLength	10		pattern	\S*.*[\p{L}\p{N}+].*	
Kind	Value	Annotation											
minLength	1												
maxLength	10												
pattern	\S*.*[\p{L}\p{N}+].*												
annotation	documentation ASK17: SFB-Standort, Postleitzahl												
source	<pre><xs:element name="PLZ" type="PLZ_Stp" minOccurs="0"> <xs:annotation> <xs:documentation>ASK17: SFB-Standort, Postleitzahl</xs:documentation> </xs:annotation> </xs:element></pre>												

element SFB_Standort_Ctp/Ort

diagram	
namespace	MD:/xml-schema/MD-basis/3.5
type	Ort_Stp

properties	minOcc 0 maxOcc 1 content simple
facets	Kind Value Annotation minLength 1 maxLength 40 pattern \S*.[\p{L}].*
annotation	documentation ASK18: SFB-Standort, Ort
source	<xs:element name="Ort" type="Ort_Stp" minOccurs="0"> <xs:annotation> <xs:documentation>ASK18: SFB-Standort, Ort</xs:documentation> </xs:annotation> </xs:element>

complexType Versicherter_Ctp

diagram	
namespace	MD:/xml-schema/MD-basis/3.5
children	KV_PV_Nummer Person Adresse Kontakt

used by	elements Beauftragung/Versicherter Begutachtung/Versicherter
annotation	documentation ASV: Stammdaten Versicherter
source	<pre> <xs:complexType name="Versicherter_Ctp"> <xs:annotation> <xs:documentation>ASV: Stammdaten Versicherter</xs:documentation> </xs:annotation> <xs:sequence> <xs:element name="KV_PV_Nummer" type="KV_PV_Nummer_Stp"> <xs:annotation> <xs:documentation>ASV06: Kranken-/ Pfl egeversichertennummer</xs:documentation> </xs:annotation> </xs:element> <xs:element name="Person"> <xs:annotation> <xs:documentation>ASV01: Name des Versicherten, ASV02: Vorname des Versicherten, ASV03: Titel des Versicherten, ASV04: Geburtsdatum, ASV05: Geschlecht, ASV13: Namenszusatz, ASV14: Vorsatzwort, ASV19: Besonders schützenswerte Person?, ASV20: Erläuterung der Gründe für eine besonders schützenswerte Person, ASV21: Genauigkeit Geburtsdatum</xs:documentation> </xs:annotation> <xs:complexType> <xs:complexContent> <xs:restriction base="Person_Ctp"> <xs:sequence> <xs:element name="Name" type="Name_Stp"/> <xs:element name="Vorname" type="Name_Stp" minOccurs="0"/> <xs:element name="Titel" type="Titel_Stp" minOccurs="0"/> <xs:element name="Geburtsdatum" type="Datum_Stp"/> <xs:element name="Geschlecht" type="Geschlecht_Stp"/> <xs:element name="Namenszusatz" type="Namenszusatz_Stp" minOccurs="0"/> <xs:element name="Vorsatzwort" type="Vorsatzwort_Stp" minOccurs="0"/> <xs:element name="Bes_schutz_Person" type="Bes_schutz_Person_Stp" minOccurs="0"/> <xs:element name="Erl_bes_schutz_Person" type="Frei text_Mit_Zeilenum_1000_Stp" minOccurs="0"/> <xs:element name="Genauigkeit_Geburtsdatum" type="Gen_Geburtsdatum_Stp" minOccurs="0"/> </xs:sequence> </xs:restriction> </xs:complexContent> </xs:complexType> </xs:element> <xs:element name="Adresse"> <xs:annotation> <xs:documentation>ASV07: Straße/ Hausnummer, ASV08: Zusatz, ASV09: Postleitzahl, ASV10: Ort, ASV18: Ortsteil, ASV11: Internationales Länderkennzeichen</xs:documentation> </xs:annotation> <xs:complexType> <xs:complexContent> </pre>

```

<xs:restriction base="Adresse_Ctp">
  <xs:sequence>
    <xs:element name="Strasse_Hausnummer" type="Strasse_Hausnummer_Stp"
mi n0ccurs="0" />
    <xs:element name="Zusatz" type="Anschri ftenzusatz_Stp"
mi n0ccurs="0" />
    <xs:element name="PLZ" type="PLZ_Stp" />
    <xs:element name="Ort" type="Ort_Stp" />
    <xs:element name="Ortsteil" type="Ort_Stp" mi n0ccurs="0" />
    <xs:element name="LKZ" type="LKZ_Stp" />
    <xs:element name="Postfach" type="Postfach_Stp" mi n0ccurs="0"
max0ccurs="0" />
  </xs:sequence>
</xs:restriction>
</xs:complexContent>
</xs:complexType>
</xs:element>
<xs:element name="Kontakt" mi n0ccurs="0">
  <xs:annotation>
    <xs:documentation>ASV12: Telefon des Versicherten, ASV16: Telefax des
Versicherten, ASV15: Mobil telefon des Versicherten, ASV17: E-Mail -Adresse des
Versicherten</xs:documentation>
  </xs:annotation>
<xs:complexType>
  <xs:complexContent>
    <xs:restriction base="Kontaktdaten_Ctp">
      <xs:sequence>
        <xs:element name="Tel efon" type="Tel efon_Stp" mi n0ccurs="0" />
        <xs:element name="Tel efax" type="Tel efax_Stp" mi n0ccurs="0" />
        <xs:element name="Mobi l tel efon" type="Mobi l tel efon_Stp"
mi n0ccurs="0" />
        <xs:element name="Emai l" type="Emai l_Stp" mi n0ccurs="0" />
      </xs:sequence>
    </xs:restriction>
  </xs:complexContent>
</xs:complexType>
</xs:element>
</xs:sequence>
</xs:complexType>

```

element Versicherter_Ctp/KV_PV_Nummer

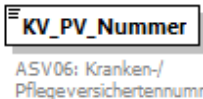
diagram							
namespace	MD:/xml-schema/MD-basis/3.5						
type	KV_PV_Nummer_Stp						
properties	content simple						
facets	<table border="0"> <tr> <td>Kind</td> <td>Value</td> <td>Annotation</td> </tr> <tr> <td>minLength</td> <td>1</td> <td></td> </tr> </table>	Kind	Value	Annotation	minLength	1	
Kind	Value	Annotation					
minLength	1						

	maxLength 15 pattern \S+([-ÿ]*)
annotation	documentation ASV06: Kranken-/ Pflegeversichertennummer
source	<pre> <xs:element name="KV_PV_Nummer" type="KV_PV_Nummer_Stp"> <xs:annotation> <xs:documentation>ASV06: Kranken-/ Pfl egeversi chertennummer</xs:documentation> </xs:annotation> </xs:element> </pre>

element Versicherter_Ctp/Person

diagram	<p>ASV01: Name des Versicherten, ASV02: Vorname des Versicherten, ASV03: Titel des Versicherten, ASV04: Geburtsdatum, ASV05: Geschlecht, ASV13: Namenszusatz, ASV14: Vorsatzwort, ASV19: Besonders schützenswerte Person?, ASV20: Erläuterung der Gründe für eine besonders schützenswerte Person, ASV21: Genauigkeit Geburtsdatum</p>
namespace	MD/xml-schema/MD-basis/3.5
type	restriction of Person_Ctp
properties	content complex
children	Name Vorname Titel Geburtsdatum Geschlecht Namenszusatz Vorsatzwort Bes_schutz_Person Erl_bes_schutz_Person Genauigkeit_Geburtsdatum
annotation	documentation ASV01: Name des Versicherten, ASV02: Vorname des Versicherten, ASV03: Titel des Versicherten, ASV04: Geburtsdatum, ASV05: Geschlecht, ASV13: Namenszusatz, ASV14: Vorsatzwort, ASV19: Besonders schützenswerte Person?, ASV20: Erläuterung der Gründe für eine besonders schützenswerte Person, ASV21: Genauigkeit Geburtsdatum
source	<pre> <xs:element name="Person"> <xs:annotation> <xs:documentation>ASV01: Name des Versicherten, ASV02: Vorname des Versi cherten, ASV03: Ti tel des Versi cherten, ASV04: Geburtsdatum, ASV05: Geschl echt, ASV13: Namenszusatz, ASV14: Vorsatzwort, ASV19: Besonders schützenswerte Person?, </pre>

	<pre> ASV20: Erläuterung der Gründe für eine besonders schützenswerte Person, ASV21: Genauigkeit Geburtsdatum</xs:documentation> </xs:annotation> <xs:complexType> <xs:complexContent> <xs:restriction base="Person_Ctp"> <xs:sequence> <xs:element name="Name" type="Name_Stp"/> <xs:element name="Vorname" type="Name_Stp" minOccurs="0"/> <xs:element name="Titel" type="Titel_Stp" minOccurs="0"/> <xs:element name="Geburtsdatum" type="Datum_Stp"/> <xs:element name="Geschlecht" type="Geschlecht_Stp"/> <xs:element name="Namenszusatz" type="Namenszusatz_Stp" minOccurs="0"/> <xs:element name="Vorsatzwort" type="Vorsatzwort_Stp" minOccurs="0"/> <xs:element name="Bes_schutz_Person" type="Bes_schutz_Person_Stp" minOccurs="0"/> <xs:element name="Erl_bes_schutz_Person" type="Frei_text_Mit_Zeilenum_1000_Stp" minOccurs="0"/> <xs:element name="Genauigkeit_Geburtsdatum" type="Gen_Geburtsdatum_Stp" minOccurs="0"/> </xs:sequence> </xs:restriction> </xs:complexContent> </xs:complexType> </xs:element> </pre>
--	--

element Versicherter_Ctp/Person/Name

diagram													
namespace	MD/xml-schema/MD-basis/3.5												
type	Name_Stp												
properties	content simple												
facets	<table border="1"> <thead> <tr> <th>Kind</th> <th>Value</th> <th>Annotation</th> </tr> </thead> <tbody> <tr> <td>minLength</td> <td>1</td> <td></td> </tr> <tr> <td>maxLength</td> <td>45</td> <td></td> </tr> <tr> <td>pattern</td> <td>\S*.[\p{L}].*</td> <td></td> </tr> </tbody> </table>	Kind	Value	Annotation	minLength	1		maxLength	45		pattern	\S*.[\p{L}].*	
Kind	Value	Annotation											
minLength	1												
maxLength	45												
pattern	\S*.[\p{L}].*												
source	<pre><xs:element name="Name" type="Name_Stp"/></pre>												

element Versicherter_Ctp/Person/Vorname

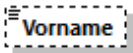
diagram					
namespace	MD/xml-schema/MD-basis/3.5				
type	Name_Stp				
properties	<table border="1"> <tbody> <tr> <td>minOcc</td> <td>0</td> </tr> <tr> <td>maxOcc</td> <td>1</td> </tr> </tbody> </table>	minOcc	0	maxOcc	1
minOcc	0				
maxOcc	1				

	content simple												
facets	<table border="1"> <thead> <tr> <th>Kind</th> <th>Value</th> <th>Annotation</th> </tr> </thead> <tbody> <tr> <td>minLength</td> <td>1</td> <td></td> </tr> <tr> <td>maxLength</td> <td>45</td> <td></td> </tr> <tr> <td>pattern</td> <td>\S*.[\p{L}].*</td> <td></td> </tr> </tbody> </table>	Kind	Value	Annotation	minLength	1		maxLength	45		pattern	\S*.[\p{L}].*	
Kind	Value	Annotation											
minLength	1												
maxLength	45												
pattern	\S*.[\p{L}].*												
source	<xs:element name="Vorname" type="Name_Stp" minOccurs="0"/>												

element Versicherter_Ctp/Person/Titel

diagram													
namespace	MD:/xml-schema/MD-basis/3.5												
type	Titel_Stp												
properties	<table border="1"> <tbody> <tr> <td>minOcc</td> <td>0</td> </tr> <tr> <td>maxOcc</td> <td>1</td> </tr> <tr> <td>content</td> <td>simple</td> </tr> </tbody> </table>	minOcc	0	maxOcc	1	content	simple						
minOcc	0												
maxOcc	1												
content	simple												
facets	<table border="1"> <thead> <tr> <th>Kind</th> <th>Value</th> <th>Annotation</th> </tr> </thead> <tbody> <tr> <td>minLength</td> <td>1</td> <td></td> </tr> <tr> <td>maxLength</td> <td>20</td> <td></td> </tr> <tr> <td>pattern</td> <td>\S*.[\p{L}].*</td> <td></td> </tr> </tbody> </table>	Kind	Value	Annotation	minLength	1		maxLength	20		pattern	\S*.[\p{L}].*	
Kind	Value	Annotation											
minLength	1												
maxLength	20												
pattern	\S*.[\p{L}].*												
source	<xs:element name="Titel" type="Titel_Stp" minOccurs="0"/>												

element Versicherter_Ctp/Person/Geburtsdatum

diagram										
namespace	MD:/xml-schema/MD-basis/3.5									
type	Datum_Stp									
properties	content simple									
facets	<table border="1"> <thead> <tr> <th>Kind</th> <th>Value</th> <th>Annotation</th> </tr> </thead> <tbody> <tr> <td>minInclusive</td> <td>1850-01-01</td> <td></td> </tr> <tr> <td>maxInclusive</td> <td>2099-12-31</td> <td></td> </tr> </tbody> </table>	Kind	Value	Annotation	minInclusive	1850-01-01		maxInclusive	2099-12-31	
Kind	Value	Annotation								
minInclusive	1850-01-01									
maxInclusive	2099-12-31									
source	<xs:element name="Geburtsdatum" type="Datum_Stp"/>									

element Versicherter_Ctp/Person/Geschlecht

diagram				
namespace	MD:/xml-schema/MD-basis/3.5			
type	Geschlecht_Stp			
properties	content simple			
facets	<table border="1"> <thead> <tr> <th>Kind</th> <th>Value</th> <th>Annotation</th> </tr> </thead> <tbody> </tbody> </table>	Kind	Value	Annotation
Kind	Value	Annotation		

	enumeration m enumeration w enumeration x enumeration d
source	<xs:element name="Geschlecht" type="Geschlecht_Stp"/>

element Versicherter_Ctp/Person/Namenszusatz

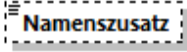
diagram													
namespace	MD:/xml-schema/MD-basis/3.5												
type	Namenszusatz_Stp												
properties	minOcc 0 maxOcc 1 content simple												
facets	<table border="1"> <thead> <tr> <th>Kind</th> <th>Value</th> <th>Annotation</th> </tr> </thead> <tbody> <tr> <td>minLength</td> <td>1</td> <td></td> </tr> <tr> <td>maxLength</td> <td>20</td> <td></td> </tr> <tr> <td>pattern</td> <td>\S*.[\p{L}].*</td> <td></td> </tr> </tbody> </table>	Kind	Value	Annotation	minLength	1		maxLength	20		pattern	\S*.[\p{L}].*	
Kind	Value	Annotation											
minLength	1												
maxLength	20												
pattern	\S*.[\p{L}].*												
source	<xs:element name="Namenszusatz" type="Namenszusatz_Stp" minOccurs="0"/>												

element Versicherter_Ctp/Person/Vorsatzwort

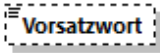
diagram													
namespace	MD:/xml-schema/MD-basis/3.5												
type	Vorsatzwort_Stp												
properties	minOcc 0 maxOcc 1 content simple												
facets	<table border="1"> <thead> <tr> <th>Kind</th> <th>Value</th> <th>Annotation</th> </tr> </thead> <tbody> <tr> <td>minLength</td> <td>1</td> <td></td> </tr> <tr> <td>maxLength</td> <td>20</td> <td></td> </tr> <tr> <td>pattern</td> <td>\S*.[\p{L}].*</td> <td></td> </tr> </tbody> </table>	Kind	Value	Annotation	minLength	1		maxLength	20		pattern	\S*.[\p{L}].*	
Kind	Value	Annotation											
minLength	1												
maxLength	20												
pattern	\S*.[\p{L}].*												
source	<xs:element name="Vorsatzwort" type="Vorsatzwort_Stp" minOccurs="0"/>												

element Versicherter_Ctp/Person/Beschutz_Person

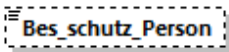
diagram	
namespace	MD:/xml-schema/MD-basis/3.5
type	Beschutz_Person_Stp
properties	minOcc 0

	maxOcc 1 content simple
facets	Kind Value Annotation enumeration 1 enumeration 2
source	<xs:element name="Bes_schutz_Person" type="Bes_schutz_Person_Stp" minOccurs="0"/>

element Versicherter_Ctp/Person/Erl_bes_schutz_Person

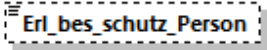
diagram	
namespace	MD:/xml-schema/MD-basis/3.5
type	Freitext Mit Zeilenum_1000_Stp
properties	minOcc 0 maxOcc 1 content simple
facets	Kind Value Annotation maxLength 1000 pattern \S+[\n\r\t -ÿ]*
source	<xs:element name="Erl_bes_schutz_Person" type="Freitext_Mit_Zeilenum_1000_Stp" minOccurs="0"/>

element Versicherter_Ctp/Person/Genauigkeit_Geburtsdatum

diagram	
namespace	MD:/xml-schema/MD-basis/3.5
type	Gen_Geburtsdatum_Stp
properties	minOcc 0 maxOcc 1 content simple
facets	Kind Value Annotation enumeration 1 enumeration 2
source	<xs:element name="Genauigkeit_Geburtsdatum" type="Gen_Geburtsdatum_Stp" minOccurs="0"/>

element Versicherter_Ctp/Adresse

<p>diagram</p>	<p> Adresse ASV07: Straße/ Hausnummer, ASV08: Zusatz, ASV09: Postleitzahl, ASV10: Ort, ASV18: Ortsteil, ASV11: Internationales Länderkennzeichen </p>
<p>namespace</p>	<p>MD/xml-schema/MD-basis/3.5</p>
<p>type</p>	<p>restriction of Adresse_Ctp</p>
<p>properties</p>	<p>content complex</p>
<p>children</p>	<p>Strasse_Hausnummer Zusatz PLZ Ort Ortsteil LKZ Postfach</p>
<p>annotation</p>	<p>documentation ASV07: Straße/ Hausnummer, ASV08: Zusatz, ASV09: Postleitzahl, ASV10: Ort, ASV18: Ortsteil, ASV11: Internationales Länderkennzeichen</p>
<p>source</p>	<pre> <xs:element name="Adresse"> <xs:annotation> <xs:documentation>ASV07: Straße/ Hausnummer, ASV08: Zusatz, ASV09: Postleitzahl, ASV10: Ort, ASV18: Ortsteil, ASV11: Internationales Länderkennzeichen</xs:documentation> </xs:annotation> <xs:complexType> <xs:complexContent> <xs:restriction base="Adresse_Ctp"> <xs:sequence> <xs:element name="Strasse_Hausnummer" type="Strasse_Hausnummer_Stp" minOccurs="0"/> <xs:element name="Zusatz" type="Anschri ftenzusatz_Stp" minOccurs="0"/> <xs:element name="PLZ" type="PLZ_Stp"/> <xs:element name="Ort" type="Ort_Stp"/> <xs:element name="Ortsteil" type="Ort_Stp" minOccurs="0"/> <xs:element name="LKZ" type="LKZ_Stp"/> <xs:element name="Postfach" type="Postfach_Stp" minOccurs="0" maxOccurs="0"/> </xs:sequence> </xs:restriction> </xs:complexContent> </xs:complexType> </xs:element> </pre>

element Versicherter_Ctp/Adresse/Strasse_Hausnummer

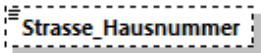
diagram	
namespace	MD:/xml-schema/MD-basis/3.5
type	Strasse_Hausnummer_Stp
properties	minOcc 0 maxOcc 1 content simple
facets	Kind Value Annotation minLength 1 maxLength 56 pattern \S*.[\p{L}].*
source	<xs:element name="Strasse_Hausnummer" type="Strasse_Hausnummer_Stp" minOccurs="0"/>

element Versicherter_Ctp/Adresse/Zusatz

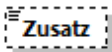
diagram	
namespace	MD:/xml-schema/MD-basis/3.5
type	Anschriftenzusatz_Stp
properties	minOcc 0 maxOcc 1 content simple
facets	Kind Value Annotation minLength 1 maxLength 40 pattern \S*.[\p{L}\p{N}].*
source	<xs:element name="Zusatz" type="Anschriftenzusatz_Stp" minOccurs="0"/>

element Versicherter_Ctp/Adresse/PLZ

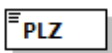
diagram	
namespace	MD:/xml-schema/MD-basis/3.5
type	PLZ_Stp
properties	content simple
facets	Kind Value Annotation minLength 1 maxLength 10 pattern \S*.[\p{L}\p{N}+].*
source	<xs:element name="PLZ" type="PLZ_Stp"/>

element Versicherter_Ctp/Adresse/Ort

diagram													
namespace	MD:/xml-schema/MD-basis/3.5												
type	Ort_Stp												
properties	content simple												
facets	<table border="1"> <thead> <tr> <th>Kind</th> <th>Value</th> <th>Annotation</th> </tr> </thead> <tbody> <tr> <td>minLength</td> <td>1</td> <td></td> </tr> <tr> <td>maxLength</td> <td>40</td> <td></td> </tr> <tr> <td>pattern</td> <td>\S*.[\p{L}].*</td> <td></td> </tr> </tbody> </table>	Kind	Value	Annotation	minLength	1		maxLength	40		pattern	\S*.[\p{L}].*	
Kind	Value	Annotation											
minLength	1												
maxLength	40												
pattern	\S*.[\p{L}].*												
source	<code><xs:element name="Ort" type="Ort_Stp"/></code>												

element Versicherter_Ctp/Adresse/Ortsteil

diagram													
namespace	MD:/xml-schema/MD-basis/3.5												
type	Ort_Stp												
properties	<table border="1"> <tbody> <tr> <td>minOcc</td> <td>0</td> </tr> <tr> <td>maxOcc</td> <td>1</td> </tr> <tr> <td>content</td> <td>simple</td> </tr> </tbody> </table>	minOcc	0	maxOcc	1	content	simple						
minOcc	0												
maxOcc	1												
content	simple												
facets	<table border="1"> <thead> <tr> <th>Kind</th> <th>Value</th> <th>Annotation</th> </tr> </thead> <tbody> <tr> <td>minLength</td> <td>1</td> <td></td> </tr> <tr> <td>maxLength</td> <td>40</td> <td></td> </tr> <tr> <td>pattern</td> <td>\S*.[\p{L}].*</td> <td></td> </tr> </tbody> </table>	Kind	Value	Annotation	minLength	1		maxLength	40		pattern	\S*.[\p{L}].*	
Kind	Value	Annotation											
minLength	1												
maxLength	40												
pattern	\S*.[\p{L}].*												
source	<code><xs:element name="Ortsteil" type="Ort_Stp" minOccurs="0"/></code>												

element Versicherter_Ctp/Adresse/LKZ

diagram													
namespace	MD:/xml-schema/MD-basis/3.5												
type	LKZ_Stp												
properties	content simple												
facets	<table border="1"> <thead> <tr> <th>Kind</th> <th>Value</th> <th>Annotation</th> </tr> </thead> <tbody> <tr> <td>minLength</td> <td>1</td> <td></td> </tr> <tr> <td>maxLength</td> <td>3</td> <td></td> </tr> <tr> <td>pattern</td> <td>[A-Z]+</td> <td></td> </tr> </tbody> </table>	Kind	Value	Annotation	minLength	1		maxLength	3		pattern	[A-Z]+	
Kind	Value	Annotation											
minLength	1												
maxLength	3												
pattern	[A-Z]+												
source	<code><xs:element name="LKZ" type="LKZ_Stp"/></code>												

element Versicherter_Ctp/Adresse/Postfach

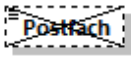
diagram	
namespace	MD:/xml-schema/MD-basis/3.5
type	Postfach_Stp
properties	minOcc 0 maxOcc 0 content simple
facets	Kind Value Annotation minLength 1 maxLength 45 pattern \S+ [-ÿ]*
source	<code><xs:element name="Postfach" type="Postfach_Stp" minOccurs="0" maxOccurs="0"/></code>

element Versicherter_Ctp/Kontakt

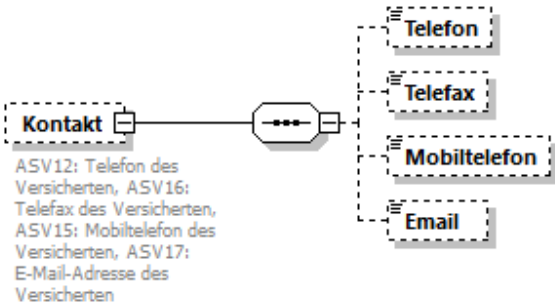
diagram	 <p>ASV12: Telefon des Versicherten, ASV16: Telefax des Versicherten, ASV15: Mobiltelefon des Versicherten, ASV17: E-Mail-Adresse des Versicherten</p>
namespace	MD:/xml-schema/MD-basis/3.5
type	restriction of Kontaktdaten_Ctp
properties	minOcc 0 maxOcc 1 content complex
children	Telefon Telefax Mobiltelefon Email
annotation	documentation ASV12: Telefon des Versicherten, ASV16: Telefax des Versicherten, ASV15: Mobiltelefon des Versicherten, ASV17: E-Mail-Adresse des Versicherten
source	<pre> <xs:element name="Kontakt" minOccurs="0"> <xs:annotation> <xs:documentation>ASV12: Telefon des Versicherten, ASV16: Telefax des Versicherten, ASV15: Mobiltelefon des Versicherten, ASV17: E-Mail-Adresse des Versicherten</xs:documentation> </xs:annotation> <xs:complexType> <xs:complexContent> <xs:restriction base="Kontaktdaten_Ctp"> <xs:sequence> <xs:element name="Telefon" type="Telefon_Stp" minOccurs="0"/> <xs:element name="Telefax" type="Telefax_Stp" minOccurs="0"/> <xs:element name="Mobiltelefon" type="Mobiltelefon_Stp" minOccurs="0"/> </xs:sequence> </xs:restriction> </xs:complexContent> </xs:complexType> </xs:element> </pre>

	<pre> <xs:element name="Email" type="Email_Stp" minOccurs="0"/> </xs:sequence> </xs:restriction> </xs:complexContent> </xs:complexType> </xs:element> </pre>
--	--

element Versicherter_Ctp/Kontakt/Telefon

diagram													
namespace	MD:/xml-schema/MD-basis/3.5												
type	Telefon_Stp												
properties	minOcc 0 maxOcc 1 content simple												
facets	<table border="1"> <thead> <tr> <th>Kind</th> <th>Value</th> <th>Annotation</th> </tr> </thead> <tbody> <tr> <td>minLength</td> <td>1</td> <td></td> </tr> <tr> <td>maxLength</td> <td>20</td> <td></td> </tr> <tr> <td>pattern</td> <td>\S*.[\p{L}\p{N}].*</td> <td></td> </tr> </tbody> </table>	Kind	Value	Annotation	minLength	1		maxLength	20		pattern	\S*.[\p{L}\p{N}].*	
Kind	Value	Annotation											
minLength	1												
maxLength	20												
pattern	\S*.[\p{L}\p{N}].*												
source	<pre><xs:element name="Telefon" type="Telefon_Stp" minOccurs="0"/></pre>												

element Versicherter_Ctp/Kontakt/Telefax

diagram													
namespace	MD:/xml-schema/MD-basis/3.5												
type	Telefax_Stp												
properties	minOcc 0 maxOcc 1 content simple												
facets	<table border="1"> <thead> <tr> <th>Kind</th> <th>Value</th> <th>Annotation</th> </tr> </thead> <tbody> <tr> <td>minLength</td> <td>1</td> <td></td> </tr> <tr> <td>maxLength</td> <td>20</td> <td></td> </tr> <tr> <td>pattern</td> <td>\S*.[\p{L}\p{N}].*</td> <td></td> </tr> </tbody> </table>	Kind	Value	Annotation	minLength	1		maxLength	20		pattern	\S*.[\p{L}\p{N}].*	
Kind	Value	Annotation											
minLength	1												
maxLength	20												
pattern	\S*.[\p{L}\p{N}].*												
source	<pre><xs:element name="Telefax" type="Telefax_Stp" minOccurs="0"/></pre>												

element Versicherter_Ctp/Kontakt/Mobiltelefon

diagram	
namespace	MD:/xml-schema/MD-basis/3.5
type	Mobiltelefon_Stp
properties	minOcc 0 maxOcc 1

	content simple												
facets	<table border="1"> <thead> <tr> <th>Kind</th> <th>Value</th> <th>Annotation</th> </tr> </thead> <tbody> <tr> <td>minLength</td> <td>1</td> <td></td> </tr> <tr> <td>maxLength</td> <td>20</td> <td></td> </tr> <tr> <td>pattern</td> <td>\S*.[\p{L}\p{N}].*</td> <td></td> </tr> </tbody> </table>	Kind	Value	Annotation	minLength	1		maxLength	20		pattern	\S*.[\p{L}\p{N}].*	
Kind	Value	Annotation											
minLength	1												
maxLength	20												
pattern	\S*.[\p{L}\p{N}].*												
source	<xs:element name="Mobi I tel efon" type="Mobi I tel efon_Stp" mi n0ccurs="0"/>												

element Versicherter_Ctp/Kontakt/Email

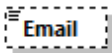
diagram													
namespace	MD/xml-schema/MD-basis/3.5												
type	Email_Stp												
properties	<table border="1"> <tbody> <tr> <td>minOcc</td> <td>0</td> </tr> <tr> <td>maxOcc</td> <td>1</td> </tr> <tr> <td>content</td> <td>simple</td> </tr> </tbody> </table>	minOcc	0	maxOcc	1	content	simple						
minOcc	0												
maxOcc	1												
content	simple												
facets	<table border="1"> <thead> <tr> <th>Kind</th> <th>Value</th> <th>Annotation</th> </tr> </thead> <tbody> <tr> <td>minLength</td> <td>1</td> <td></td> </tr> <tr> <td>maxLength</td> <td>50</td> <td></td> </tr> <tr> <td>pattern</td> <td>[_\-a-zA-Z0-9\.\+]+@[a-zA-Z0-9](\.[\-a-zA-Z0-9]*[a-zA-Z0-9])*</td> <td></td> </tr> </tbody> </table>	Kind	Value	Annotation	minLength	1		maxLength	50		pattern	[_\-a-zA-Z0-9\.\+]+@[a-zA-Z0-9](\.[\-a-zA-Z0-9]*[a-zA-Z0-9])*	
Kind	Value	Annotation											
minLength	1												
maxLength	50												
pattern	[_\-a-zA-Z0-9\.\+]+@[a-zA-Z0-9](\.[\-a-zA-Z0-9]*[a-zA-Z0-9])*												
source	<xs:element name="Email" type="Email_Stp" mi n0ccurs="0"/>												

complexType Vorherige_SFB_Ctp

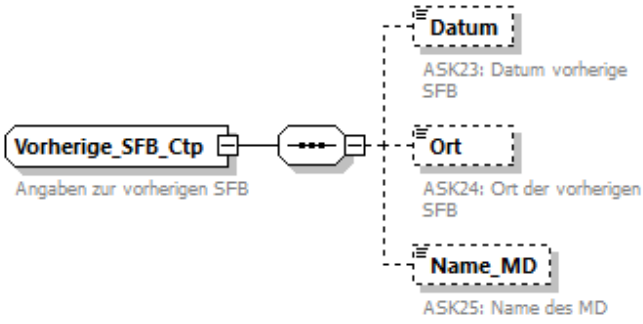
diagram	
namespace	MD/xml-schema/MD-basis/3.5
children	Datum Ort Name_MD
used by	element Kasse_Ctp/Vorherige_SFB
annotation	documentation Angaben zur vorherigen SFB
source	<pre><xs:complexType name="Vorherige_SFB_Ctp"> <xs:annotation> <xs:documentation>Angaben zur vorherigen SFB</xs:documentation> </xs:annotation> <xs:sequence> <xs:element name="Datum" type="Datum_Stp" mi n0ccurs="0"> <xs:annotation></pre>

	<pre> <xs:documentation>ASK23: Datum vorherige SFB</xs:documentation> </xs:annotation> </xs:element> <xs:element name="Ort" type="Ort_Stp" minOccurs="0"> <xs:annotation> <xs:documentation>ASK24: Ort der vorherigen SFB</xs:documentation> </xs:annotation> </xs:element> <xs:element name="Name_MD" type="Name_Stp" minOccurs="0"> <xs:annotation> <xs:documentation>ASK25: Name des MD</xs:documentation> </xs:annotation> </xs:element> </xs:sequence> </xs:complexType> </pre>
--	--

element Vorherige_SFB_Ctp/Datum

diagram										
namespace	MD:/xml-schema/MD-basis/3.5									
type	Datum_Stp									
properties	minOcc 0 maxOcc 1 content simple									
facets	<table border="1"> <thead> <tr> <th>Kind</th> <th>Value</th> <th>Annotation</th> </tr> </thead> <tbody> <tr> <td>minInclusive</td> <td>1850-01-01</td> <td></td> </tr> <tr> <td>maxInclusive</td> <td>2099-12-31</td> <td></td> </tr> </tbody> </table>	Kind	Value	Annotation	minInclusive	1850-01-01		maxInclusive	2099-12-31	
Kind	Value	Annotation								
minInclusive	1850-01-01									
maxInclusive	2099-12-31									
annotation	documentation ASK23: Datum vorherige SFB									
source	<pre> <xs:element name="Datum" type="Datum_Stp" minOccurs="0"> <xs:annotation> <xs:documentation>ASK23: Datum vorherige SFB</xs:documentation> </xs:annotation> </xs:element> </pre>									

element Vorherige_SFB_Ctp/Ort

diagram	
namespace	MD:/xml-schema/MD-basis/3.5
type	Ort_Stp
properties	minOcc 0 maxOcc 1 content simple

facets	<table border="1"> <thead> <tr> <th>Kind</th> <th>Value</th> <th>Annotation</th> </tr> </thead> <tbody> <tr> <td>minLength</td> <td>1</td> <td></td> </tr> <tr> <td>maxLength</td> <td>40</td> <td></td> </tr> <tr> <td>pattern</td> <td>\S*.[\p{L}].*</td> <td></td> </tr> </tbody> </table>	Kind	Value	Annotation	minLength	1		maxLength	40		pattern	\S*.[\p{L}].*	
Kind	Value	Annotation											
minLength	1												
maxLength	40												
pattern	\S*.[\p{L}].*												
annotation	documentation ASK24: Ort der vorherigen SFB												
source	<pre><xs:element name="Ort" type="Ort_Stp" minOccurs="0"> <xs:annotation> <xs:documentation>ASK24: Ort der vorherigen SFB</xs:documentation> </xs:annotation> </xs:element></pre>												

element Vorherige_SFB_Ctp/Name_MD

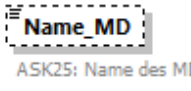
diagram													
namespace	MD:/xml-schema/MD-basis/3.5												
type	Name_Stp												
properties	<table border="1"> <tbody> <tr> <td>minOcc</td> <td>0</td> </tr> <tr> <td>maxOcc</td> <td>1</td> </tr> <tr> <td>content</td> <td>simple</td> </tr> </tbody> </table>	minOcc	0	maxOcc	1	content	simple						
minOcc	0												
maxOcc	1												
content	simple												
facets	<table border="1"> <thead> <tr> <th>Kind</th> <th>Value</th> <th>Annotation</th> </tr> </thead> <tbody> <tr> <td>minLength</td> <td>1</td> <td></td> </tr> <tr> <td>maxLength</td> <td>45</td> <td></td> </tr> <tr> <td>pattern</td> <td>\S*.[\p{L}].*</td> <td></td> </tr> </tbody> </table>	Kind	Value	Annotation	minLength	1		maxLength	45		pattern	\S*.[\p{L}].*	
Kind	Value	Annotation											
minLength	1												
maxLength	45												
pattern	\S*.[\p{L}].*												
annotation	documentation ASK25: Name des MD												
source	<pre><xs:element name="Name_MD" type="Name_Stp" minOccurs="0"> <xs:annotation> <xs:documentation>ASK25: Name des MD</xs:documentation> </xs:annotation> </xs:element></pre>												

simpleType Abteilungstyp_Stp

namespace	MD:/xml-schema/MD-basis/3.5																		
type	restriction of xs:string																		
properties	base xs:string																		
used by	<table border="1"> <tbody> <tr> <td>element</td> <td>Begutachtung/Stellungnahme/Pruefung/Entlassung/Abteilungstyp</td> </tr> <tr> <td>attribute</td> <td>Beauftragung/Auftrag/Infos/Entlassung/@abteilungstyp</td> </tr> </tbody> </table>	element	Begutachtung/Stellungnahme/Pruefung/Entlassung/Abteilungstyp	attribute	Beauftragung/Auftrag/Infos/Entlassung/@abteilungstyp														
element	Begutachtung/Stellungnahme/Pruefung/Entlassung/Abteilungstyp																		
attribute	Beauftragung/Auftrag/Infos/Entlassung/@abteilungstyp																		
facets	<table border="1"> <thead> <tr> <th>Kind</th> <th>Value</th> <th>Annotation</th> </tr> </thead> <tbody> <tr> <td>enumeration</td> <td>1</td> <td></td> </tr> <tr> <td>enumeration</td> <td>2</td> <td></td> </tr> <tr> <td>enumeration</td> <td>3</td> <td></td> </tr> <tr> <td>enumeration</td> <td>4</td> <td></td> </tr> <tr> <td>enumeration</td> <td>5</td> <td></td> </tr> </tbody> </table>	Kind	Value	Annotation	enumeration	1		enumeration	2		enumeration	3		enumeration	4		enumeration	5	
Kind	Value	Annotation																	
enumeration	1																		
enumeration	2																		
enumeration	3																		
enumeration	4																		
enumeration	5																		

	<p>enumeration 6</p> <p>enumeration 7</p> <p>enumeration 8</p> <p>enumeration A</p> <p>enumeration B</p> <p>enumeration C</p> <p>enumeration D</p> <p>enumeration E</p> <p>enumeration F</p> <p>enumeration G</p> <p>enumeration H</p>
annotation	<p>documentation</p> <p>TA301 Schlüssel 4 (3.Stelle): Abteilungstyp</p> <p>0 = keine Fallpauschale/kein Sonderentgelt - stillgelegt</p> <p>1 = Hauptabteilung</p> <p>2 = Hauptabteilung mit Beleghebamme</p> <p>3 = Belegopérateur</p> <p>4 = Belegopérateur und Beleganästhesist</p> <p>5 = Belegopérateur und Beleghebamme</p> <p>6 = Belegopérateur, Beleganästhesist und Beleghebamme</p> <p>7 = Teilstationäre Versorgung (für teilstationäre DRG-Fallpauschalen)</p> <p>8 = Belegarzt mit Honorarvertrag</p> <p>A = Hauptabteilung</p> <p>B = reserviert</p> <p>C = Belegopérateur</p> <p>D = Belegopérateur und Beleganästhesist</p> <p>E = reserviert</p> <p>F = reserviert</p> <p>G = reserviert</p> <p>H = reserviert</p>
source	<pre> <xs:simpleType name="Abteilungstyp_Stp"> <xs:annotation> <xs:documentation>TA301 Schlüssel 4 (3.Stelle): Abteilungstyp 0 = keine Fallpauschale/kein Sonderentgelt - stillgelegt 1 = Hauptabteilung 2 = Hauptabteilung mit Beleghebamme 3 = Belegopérateur 4 = Belegopérateur und Beleganästhesist 5 = Belegopérateur und Beleghebamme 6 = Belegopérateur, Beleganästhesist und Beleghebamme 7 = Teilstationäre Versorgung (für teilstationäre DRG-Fallpauschalen) 8 = Belegarzt mit Honorarvertrag A = Hauptabteilung B = reserviert C = Belegopérateur D = Belegopérateur und Beleganästhesist E = reserviert F = reserviert G = reserviert H = reserviert </xs:documentation> </xs:annotation> <xs:restriction base="xs:string"> </pre>

	<pre> <xs:enumeration value="1"/> <xs:enumeration value="2"/> <xs:enumeration value="3"/> <xs:enumeration value="4"/> <xs:enumeration value="5"/> <xs:enumeration value="6"/> <xs:enumeration value="7"/> <xs:enumeration value="8"/> <xs:enumeration value="A"/> <xs:enumeration value="B"/> <xs:enumeration value="C"/> <xs:enumeration value="D"/> <xs:enumeration value="E"/> <xs:enumeration value="F"/> <xs:enumeration value="G"/> <xs:enumeration value="H"/> </xs:restriction> </xs:simpleType> </pre>
--	---

simpleType Abw_Anschrift_Stp

namespace	MD:/xml-schema/MD-basis/3.5												
type	restriction of GI4X-basis:ISO88591_Stp												
properties	base GI4X-basis:ISO88591_Stp												
used by	element Arzt_Ctp/Abw_Bez_Anschrift												
facets	<table border="1"> <thead> <tr> <th>Kind</th> <th>Value</th> <th>Annotation</th> </tr> </thead> <tbody> <tr> <td>minLength</td> <td>1</td> <td></td> </tr> <tr> <td>maxLength</td> <td>80</td> <td></td> </tr> <tr> <td>pattern</td> <td>\S*.*[\p{L}].*</td> <td></td> </tr> </tbody> </table>	Kind	Value	Annotation	minLength	1		maxLength	80		pattern	\S*.*[\p{L}].*	
Kind	Value	Annotation											
minLength	1												
maxLength	80												
pattern	\S*.*[\p{L}].*												
annotation	documentation Abweichende Bezeichnung der Anschrift. Es muss mindestens ein Buchstabe enthalten sein.												
source	<pre> <xs:simpleType name="Abw_Anschrift_Stp"> <xs:annotation> <xs:documentation>Abweichende Bezeichnung der Anschrift. Es muss mindestens ein Buchstabe enthalten sein.</xs:documentation> </xs:annotation> <xs:restriction base="GI4X-basis:ISO88591_Stp"> <xs:maxLength value="80"/> <xs:pattern value="\S*.*[\p{L}].*" /> </xs:restriction> </xs:simpleType> </pre>												

simpleType Aktenzeichen_Stp

namespace	MD:/xml-schema/MD-basis/3.5
type	restriction of Char20_Stp
properties	base Char20_Stp

used by	elements Aktenzeichen_Ctp/Aktenzeichen Aktenzeichen_anderer_Begutachtungsfall_Ctp/Aktenzeichen attributes Aktenzeichen_1Folge Aktenzeichen_Ctp/Aktenzeichen_2Folge Beauftragung/Storno/@aktenzeichen Begutachtung/Zwischennachricht/Pruefantrag/@aktenzeichen
facets	Kind Value Annotation minLength 2 maxLength 18 pattern \S+ [-ÿ]*
annotation	documentation Aktenzeichen
source	<pre><xs:simpleType name="Aktenzeichen_Stp"> <xs:annotation> <xs:documentation>Aktenzeichen</xs:documentation> </xs:annotation> <xs:restriction base="Char20_Stp"> <xs:minLength value="2"/> <xs:maxLength value="18"/> </xs:restriction> </xs:simpleType></pre>

simpleType Anderer_Adressat_Stp

namespace	MD/xml-schema/MD-basis/3.5
type	restriction of xs:string
properties	base xs:string
used by	element Adressat_Oder_Adresse_Ctp/Adressatsart
facets	Kind Value Annotation enumeration 2 enumeration 3 enumeration 4 enumeration 5 enumeration 6
annotation	documentation Schlüssel Anderer Adressat als Versicherter 2 Abweichender Aufenthaltsort des Versicherten 3 Erziehungsberechtigter / gesetzlicher Vertreter 4 Anderweitige 5 Bevollmächtigter 6 Betreuer
source	<pre><xs:simpleType name="Anderer_Adressat_Stp"> <xs:annotation> <xs:documentation>Schlüssel Anderer Adressat als Versi cherter 2 Abwei chender Aufenthal tsort des Versi cherten 3 Erzi ehungsberechtigter / geset zlicher Vertreter 4 Anderwei tige 5 Bevol lmächtigter 6 Betreuer </xs:documentati on> </xs:annotati on> <xs:restricti on base="xs:stri ng"></pre>

	<pre> <xs:enumeration value="2"/> <xs:enumeration value="3"/> <xs:enumeration value="4"/> <xs:enumeration value="5"/> <xs:enumeration value="6"/> </xs:restriction> </xs:simpleType> </pre>
--	---

simpleType Anrede_Stp

namespace	MD:/xml-schema/MD-basis/3.5												
type	restriction of G14X-basis:ISO88591_Stp												
properties	base G14X-basis:ISO88591_Stp												
used by	element Kasse_Ctp/Anrede												
facets	<table border="1"> <thead> <tr> <th>Kind</th> <th>Value</th> <th>Annotation</th> </tr> </thead> <tbody> <tr> <td>minLength</td> <td>1</td> <td></td> </tr> <tr> <td>maxLength</td> <td>10</td> <td></td> </tr> <tr> <td>pattern</td> <td>\S*.[\p{L}].*</td> <td></td> </tr> </tbody> </table>	Kind	Value	Annotation	minLength	1		maxLength	10		pattern	\S*.[\p{L}].*	
Kind	Value	Annotation											
minLength	1												
maxLength	10												
pattern	\S*.[\p{L}].*												
annotation	documentation Ansprechpartner Anrede. Es muss mindestens ein Buchstabe enthalten sein.												
source	<pre> <xs:simpleType name="Anrede_Stp"> <xs:annotation> <xs:documentation>Ansprechpartner Anrede. Es muss mindestens ein Buchstabe enthalten sein.</xs:documentation> </xs:annotation> <xs:restriction base="G14X-basis:ISO88591_Stp"> <xs:maxLength value="10"/> <xs:pattern value="\S*.[\p{L}].*" /> </xs:restriction> </xs:simpleType> </pre>												

simpleType Anschriftenzusatz_Stp

namespace	MD:/xml-schema/MD-basis/3.5												
type	restriction of G14X-basis:ISO88591_Stp												
properties	base G14X-basis:ISO88591_Stp												
used by	elements Adresse_Ctp/Zusatz Adressat_Oder_Adresse_Ctp/Adresse/Zusatz Arzt_Ctp/Adresse/Zusatz Kasse_Ctp/Adresse/Zusatz Leistungserbringer_Ctp/Adresse/Zusatz MD_Ctp/Adresse/Zusatz Versicherter_Ctp/Adresse/Zusatz												
facets	<table border="1"> <thead> <tr> <th>Kind</th> <th>Value</th> <th>Annotation</th> </tr> </thead> <tbody> <tr> <td>minLength</td> <td>1</td> <td></td> </tr> <tr> <td>maxLength</td> <td>40</td> <td></td> </tr> <tr> <td>pattern</td> <td>\S*.[\p{L}\p{N}].*</td> <td></td> </tr> </tbody> </table>	Kind	Value	Annotation	minLength	1		maxLength	40		pattern	\S*.[\p{L}\p{N}].*	
Kind	Value	Annotation											
minLength	1												
maxLength	40												
pattern	\S*.[\p{L}\p{N}].*												
annotation	documentation Zusatz zur Straße und Hausnummer. Es muss mindestens ein Buchstabe enthalten sein.												
source	<pre> <xs:simpleType name="Anschriftenzusatz_Stp"> <xs:annotation> </pre>												

	<pre> <xs:documentation>Zusatz zur Straße und Hausnummer. Es muss mindestens ein Buchstabe enthalten sein.</xs:documentation> </xs:annotation> <xs:restriction base="GI4X-basis:ISO88591_Stp"> <xs:maxLength value="40"/> <xs:pattern value="\S*.*[\p{L}\p{N}].*" /> </xs:restriction> </xs:simpleType> </pre>
--	--

simpleType Anzahl2_Stp

namespace	MD:/xml-schema/MD-basis/3.5						
type	restriction of xs:integer						
properties	base xs:integer						
facets	<table border="1"> <thead> <tr> <th>Kind</th> <th>Value</th> <th>Annotation</th> </tr> </thead> <tbody> <tr> <td>pattern</td> <td>[0-9]([1-9][0-9])</td> <td></td> </tr> </tbody> </table>	Kind	Value	Annotation	pattern	[0-9]([1-9][0-9])	
Kind	Value	Annotation					
pattern	[0-9]([1-9][0-9])						
annotation	documentation numerische Anzahl maximal zweistellig, ohne führende Nullen						
source	<pre> <xs:simpleType name="Anzahl2_Stp"> <xs:annotation> <xs:documentation>numerische Anzahl maximal zweistellig, ohne führende Nullen</xs:documentation> </xs:annotation> <xs:restriction base="xs:integer"> <xs:pattern value="[0-9]([1-9][0-9])" /> </xs:restriction> </xs:simpleType> </pre>						

simpleType Anzahl_0_14_Stp

namespace	MD:/xml-schema/MD-basis/3.5						
type	restriction of xs:integer						
properties	base xs:integer						
facets	<table border="1"> <thead> <tr> <th>Kind</th> <th>Value</th> <th>Annotation</th> </tr> </thead> <tbody> <tr> <td>pattern</td> <td>((0-9) (1[0-4])</td> <td></td> </tr> </tbody> </table>	Kind	Value	Annotation	pattern	((0-9) (1[0-4])	
Kind	Value	Annotation					
pattern	((0-9) (1[0-4])						
annotation	documentation Anzahl 0 bis 14						
source	<pre> <xs:simpleType name="Anzahl_0_14_Stp"> <xs:annotation> <xs:documentation>Anzahl 0 bis 14</xs:documentation> </xs:annotation> <xs:restriction base="xs:integer"> <xs:pattern value="([0-9]) (1[0-4])" /> </xs:restriction> </xs:simpleType> </pre>						

simpleType Anzahl_1_13_Stp

namespace	MD:/xml-schema/MD-basis/3.5						
type	restriction of xs:integer						
properties	base xs:integer						
facets	<table border="1"> <thead> <tr> <th>Kind</th> <th>Value</th> <th>Annotation</th> </tr> </thead> <tbody> <tr> <td>pattern</td> <td>([1-9])(1[0-3])</td> <td></td> </tr> </tbody> </table>	Kind	Value	Annotation	pattern	([1-9])(1[0-3])	
Kind	Value	Annotation					
pattern	([1-9])(1[0-3])						
annotation	documentation Anzahl 1 bis 13, ohne führende Null						
source	<pre> <xs:simpleType name="Anzahl_1_13_Stp"> <xs:annotation> <xs:documentation>Anzahl 1 bis 13, ohne führende Null</xs:documentation> </xs:annotation> <xs:restriction base="xs:integer"> <xs:pattern value="([1-9])(1[0-3])"/> </xs:restriction> </xs:simpleType> </pre>						

simpleType Anzahl_1_99_Stp

namespace	MD:/xml-schema/MD-basis/3.5						
type	restriction of xs:integer						
properties	base xs:integer						
facets	<table border="1"> <thead> <tr> <th>Kind</th> <th>Value</th> <th>Annotation</th> </tr> </thead> <tbody> <tr> <td>pattern</td> <td>[1-9]([1-9][0-9])</td> <td></td> </tr> </tbody> </table>	Kind	Value	Annotation	pattern	[1-9]([1-9][0-9])	
Kind	Value	Annotation					
pattern	[1-9]([1-9][0-9])						
annotation	documentation Anzahl 1 bis 99, ohne führende Null						
source	<pre> <xs:simpleType name="Anzahl_1_99_Stp"> <xs:annotation> <xs:documentation>Anzahl 1 bis 99, ohne führende Null</xs:documentation> </xs:annotation> <xs:restriction base="xs:integer"> <xs:pattern value="[1-9]([1-9][0-9])"/> </xs:restriction> </xs:simpleType> </pre>						

simpleType Bes_schutz_Person_Stp

namespace	MD:/xml-schema/MD-basis/3.5									
type	restriction of xs:integer									
properties	base xs:integer									
used by	elements Person_Ctp/Bes_schutz_Person Adressat Oder Adresse_Ctp/Person/Bes_schutz_Person Arzt_Ctp/Person/Bes_schutz_Person Versicherter_Ctp/Person/Bes_schutz_Person									
facets	<table border="1"> <thead> <tr> <th>Kind</th> <th>Value</th> <th>Annotation</th> </tr> </thead> <tbody> <tr> <td>enumeration</td> <td>1</td> <td></td> </tr> <tr> <td>enumeration</td> <td>2</td> <td></td> </tr> </tbody> </table>	Kind	Value	Annotation	enumeration	1		enumeration	2	
Kind	Value	Annotation								
enumeration	1									
enumeration	2									
annotation	documentation									

	Kein Eintrag = keine oder nicht bekannt 1 = besonders schützenswerte Person 2 = Mitarbeiter*in der Kranken-/Pflegekasse oder Angehörige
source	<pre><xs:simpleType name="Bes_schutz_Person_Stp"> <xs:annotation> <xs:documentation> Kein Eintrag = keine oder nicht bekannt 1 = besonders schützenswerte Person 2 = Mitarbeiter*in der Kranken-/Pflegekasse oder Angehörige </xs:documentation> </xs:annotation> <xs:restriction base="xs:integer"> <xs:enumeration value="1"/> <xs:enumeration value="2"/> </xs:restriction> </xs:simpleType></pre>

simpleType BSNR_Stp

namespace	MD:/xml-schema/MD-basis/3.5												
type	G14X-basis:BSNR_Stp												
properties	base G14X-basis:BSNR_Stp												
used by	element Identifikationsmerkmal_Ctp/BSNR												
facets	<table border="1"> <thead> <tr> <th>Kind</th> <th>Value</th> <th>Annotation</th> </tr> </thead> <tbody> <tr> <td>minLength</td> <td>9</td> <td></td> </tr> <tr> <td>maxLength</td> <td>9</td> <td></td> </tr> <tr> <td>pattern</td> <td>[0-9]+</td> <td></td> </tr> </tbody> </table>	Kind	Value	Annotation	minLength	9		maxLength	9		pattern	[0-9]+	
Kind	Value	Annotation											
minLength	9												
maxLength	9												
pattern	[0-9]+												
annotation	documentation Die Betriebsstättennummer. Die BSNR besteht aus 9 Ziffern, keine führende 0.												
source	<pre><xs:simpleType name="BSNR_Stp"> <xs:annotation> <xs:documentation>Die Betriebsstättennummer. Die BSNR besteht aus 9 Ziffern, keine führende 0.</xs:documentation> </xs:annotation> <xs:restriction base="G14X-basis:BSNR_Stp"/> </xs:simpleType></pre>												

simpleType Char10_Stp

namespace	MD:/xml-schema/MD-basis/3.5									
type	restriction of Freitext Ohne Zeilenumbrueche_Stp									
properties	base Freitext Ohne Zeilenumbrueche_Stp									
used by	simpleType Nebenstellennummer_Stp									
facets	<table border="1"> <thead> <tr> <th>Kind</th> <th>Value</th> <th>Annotation</th> </tr> </thead> <tbody> <tr> <td>maxLength</td> <td>10</td> <td></td> </tr> <tr> <td>pattern</td> <td>\S+ [&#x0020;-&#x00FF;]*</td> <td></td> </tr> </tbody> </table>	Kind	Value	Annotation	maxLength	10		pattern	\S+ [-ÿ]*	
Kind	Value	Annotation								
maxLength	10									
pattern	\S+ [-ÿ]*									

annotation	documentation alphanumerisch maximal 10 Stellen
source	<pre><xs:simpleType name="Char10_Stp"> <xs:annotation> <xs:documentation>alphanumerisch maximal 10 Stellen</xs:documentation> </xs:annotation> <xs:restriction base="Freitext_Ohne_Zeilenumbrueche_Stp"> <xs:maxLength value="10"/> </xs:restriction> </xs:simpleType></pre>

simpleType Char20_Stp

namespace	MD:/xml-schema/MD-basis/3.5									
type	restriction of Freitext_Ohne_Zeilenumbrueche_Stp									
properties	base Freitext_Ohne_Zeilenumbrueche_Stp									
used by	simpleTypes Aktenzeichen_Stp KV_PV_Nummer_Stp Zahnarzt_NR_Stp									
facets	<table border="1"> <thead> <tr> <th>Kind</th> <th>Value</th> <th>Annotation</th> </tr> </thead> <tbody> <tr> <td>maxLength</td> <td>20</td> <td></td> </tr> <tr> <td>pattern</td> <td>\S+ [&#x0020;-&#x00FF;]*</td> <td></td> </tr> </tbody> </table>	Kind	Value	Annotation	maxLength	20		pattern	\S+ [-ÿ]*	
Kind	Value	Annotation								
maxLength	20									
pattern	\S+ [-ÿ]*									
annotation	documentation alphanumerisch maximal 20 Stellen									
source	<pre><xs:simpleType name="Char20_Stp"> <xs:annotation> <xs:documentation>alphanumerisch maximal 20 Stellen</xs:documentation> </xs:annotation> <xs:restriction base="Freitext_Ohne_Zeilenumbrueche_Stp"> <xs:maxLength value="20"/> </xs:restriction> </xs:simpleType></pre>									

simpleType Char25_Stp

namespace	MD:/xml-schema/MD-basis/3.5									
type	restriction of Freitext_Ohne_Zeilenumbrueche_Stp									
properties	base Freitext_Ohne_Zeilenumbrueche_Stp									
facets	<table border="1"> <thead> <tr> <th>Kind</th> <th>Value</th> <th>Annotation</th> </tr> </thead> <tbody> <tr> <td>maxLength</td> <td>25</td> <td></td> </tr> <tr> <td>pattern</td> <td>\S+ [&#x0020;-&#x00FF;]*</td> <td></td> </tr> </tbody> </table>	Kind	Value	Annotation	maxLength	25		pattern	\S+ [-ÿ]*	
Kind	Value	Annotation								
maxLength	25									
pattern	\S+ [-ÿ]*									
annotation	documentation alphanumerisch maximal 25 Stellen									
source	<pre><xs:simpleType name="Char25_Stp"> <xs:annotation> <xs:documentation>alphanumerisch maximal 25 Stellen</xs:documentation> </xs:annotation> <xs:restriction base="Freitext_Ohne_Zeilenumbrueche_Stp"> <xs:maxLength value="25"/> </xs:restriction> </xs:simpleType></pre>									

	<pre></xs:restriction> </xs:simpleType></pre>
--	---

simpleType Char28_Stp

namespace	MD:/xml-schema/MD-basis/3.5									
type	restriction of Freitext_Ohne_Zeilenumbrueche_Stp									
properties	base Freitext_Ohne_Zeilenumbrueche_Stp									
facets	<table border="1"> <thead> <tr> <th>Kind</th> <th>Value</th> <th>Annotation</th> </tr> </thead> <tbody> <tr> <td>maxLength</td> <td>28</td> <td></td> </tr> <tr> <td>pattern</td> <td>\S+ [&#x0020;-&#x00FF;]*</td> <td></td> </tr> </tbody> </table>	Kind	Value	Annotation	maxLength	28		pattern	\S+ [-ÿ]*	
Kind	Value	Annotation								
maxLength	28									
pattern	\S+ [-ÿ]*									
annotation	documentation alphanumerisch maximal 28 Stellen									
source	<pre><xs:simpleType name="Char28_Stp"> <xs:annotation> <xs:documentation>alphanumerisch maximal 28 Stellen</xs:documentation> </xs:annotation> <xs:restriction base="Freitext_Ohne_Zeilenumbrueche_Stp"> <xs:maxLength value="28" /> </xs:restriction> </xs:simpleType></pre>									

simpleType Char30_Stp

namespace	MD:/xml-schema/MD-basis/3.5									
type	restriction of Freitext_Ohne_Zeilenumbrueche_Stp									
properties	base Freitext_Ohne_Zeilenumbrueche_Stp									
used by	simpleTypes Facharztbezeichnung_Stp Sachbearbeiter_Orga_Stp									
facets	<table border="1"> <thead> <tr> <th>Kind</th> <th>Value</th> <th>Annotation</th> </tr> </thead> <tbody> <tr> <td>maxLength</td> <td>30</td> <td></td> </tr> <tr> <td>pattern</td> <td>\S+ [&#x0020;-&#x00FF;]*</td> <td></td> </tr> </tbody> </table>	Kind	Value	Annotation	maxLength	30		pattern	\S+ [-ÿ]*	
Kind	Value	Annotation								
maxLength	30									
pattern	\S+ [-ÿ]*									
annotation	documentation alphanumerisch maximal 30 Stellen									
source	<pre><xs:simpleType name="Char30_Stp"> <xs:annotation> <xs:documentation>alphanumerisch maximal 30 Stellen</xs:documentation> </xs:annotation> <xs:restriction base="Freitext_Ohne_Zeilenumbrueche_Stp"> <xs:maxLength value="30" /> </xs:restriction> </xs:simpleType></pre>									

simpleType Char50_Stp

namespace	MD:/xml-schema/MD-basis/3.5
type	restriction of Freitext_Ohne_Zeilenumbrueche_Stp

properties	base Freitext_Ohne_Zeilenumbrueche_Stp									
used by	simpleTypes Fallnummer_Stp Postfach_Stp									
facets	<table border="1"> <thead> <tr> <th>Kind</th> <th>Value</th> <th>Annotation</th> </tr> </thead> <tbody> <tr> <td>maxLength</td> <td>50</td> <td></td> </tr> <tr> <td>pattern</td> <td>\S+ [&#x0020;-&#x00FF;]*</td> <td></td> </tr> </tbody> </table>	Kind	Value	Annotation	maxLength	50		pattern	\S+ [-ÿ]*	
Kind	Value	Annotation								
maxLength	50									
pattern	\S+ [-ÿ]*									
annotation	documentation alphanumerisch maximal 50 Stellen									
source	<pre><xs:simpleType name="Char50_Stp"> <xs:annotation> <xs:documentation>alphanumerisch maximal 50 Stellen</xs:documentation> </xs:annotation> <xs:restriction base="Freitext_Ohne_Zeilenumbrueche_Stp"> <xs:maxLength value="50" /> </xs:restriction> </xs:simpleType></pre>									

simpleType Char80_Stp

namespace	MD:/xml-schema/MD-basis/3.5									
type	restriction of Freitext_Ohne_Zeilenumbrueche_Stp									
properties	base Freitext_Ohne_Zeilenumbrueche_Stp									
facets	<table border="1"> <thead> <tr> <th>Kind</th> <th>Value</th> <th>Annotation</th> </tr> </thead> <tbody> <tr> <td>maxLength</td> <td>80</td> <td></td> </tr> <tr> <td>pattern</td> <td>\S+ [&#x0020;-&#x00FF;]*</td> <td></td> </tr> </tbody> </table>	Kind	Value	Annotation	maxLength	80		pattern	\S+ [-ÿ]*	
Kind	Value	Annotation								
maxLength	80									
pattern	\S+ [-ÿ]*									
annotation	documentation alphanumerisch maximal 80 Stellen									
source	<pre><xs:simpleType name="Char80_Stp"> <xs:annotation> <xs:documentation>alphanumerisch maximal 80 Stellen</xs:documentation> </xs:annotation> <xs:restriction base="Freitext_Ohne_Zeilenumbrueche_Stp"> <xs:maxLength value="80" /> </xs:restriction> </xs:simpleType></pre>									

simpleType Datum_Stp

namespace	MD:/xml-schema/MD-basis/3.5
type	restriction of xs:date
properties	base xs:date
used by	elements Beauftragung/Auftrag/Infos/Entlassung/Basisentgeltwert Entlas Guelt Vorherige SFB Ctp/Datum Begutachtung/Stellungnahme/Pruefung/Angef Gelief Unterlagen/Datum Anforderung Begutachtung/Zwischennachricht ZEP/Anfrage ZEP/Datum Anfrage Beauftragung/Zwischennachricht ZAP/Datum Antwort Begutachtung/Stellungnahme/Pruefung/Angef Gelief Unterlagen/Datum Bereitstellung Beauftragung/Auftrag/Infos/Entlassung/Entbindung Begutachtung/Stellungnahme/Pruefung/Entlassung/Entbindung Beauftragung/Auftrag/Infos/Falldaten/Entlassung

	<p>attributes</p> <p>Begutachtung/Stellungnahme/Pruefung/Falldaten/Entlassung Person Ctp/Geburtsdatum Adressat Oder Adresse Ctp/Person/Geburtsdatum Arzt Ctp/Person/Geburtsdatum Versicherter Ctp/Person/Geburtsdatum Beauftragung/Auftrag/Infos/Entgelte/@abrechnung_bis Begutachtung/Stellungnahme/Pruefung/Entgelte/KH/@abrechnung_bis Begutachtung/Stellungnahme/Pruefung/Entgelte/MD/@abrechnung_bis Beauftragung/Auftrag/Infos/Entgelte/@abrechnung_von Begutachtung/Stellungnahme/Pruefung/Entgelte/KH/@abrechnung_von Begutachtung/Stellungnahme/Pruefung/Entgelte/MD/@abrechnung_von Beauftragung/Auftrag/Infos/Verlaengerungen/@aufnahme Beauftragung/Auftrag/Infos/Verlegungen/@bis Beauftragung/Auftrag/Infos/Prozeduren/Prozedur/@datum Begutachtung/Zwischennachricht/Pruefantrag/@datum_anzeige Begutachtung/Zwischennachricht/Pruefantrag/@datum_beauftragung Begutachtung/Zwischennachricht/Pruefantrag/@datum_erweiterung Begutachtung/Stellungnahme/Pruefung/Prozeduren/Prozedur/KH/@datum_ops Begutachtung/Stellungnahme/Pruefung/Prozeduren/Prozedur/MD/@datum_ops Begutachtung/Stellungnahme/@datum_unterlagenanforderung Beauftragung/Auftrag/Infos/Standorte/@ende_datum Beauftragung/Auftrag/Infos/Verlaengerungen/@entlassung Beauftragung/Auftrag/Infos/Entlassung/@entlassungsdatum_vkz_Grp/@erstellungsdatum Beauftragung/Auftrag/@rechnungsdatum_Beauftragung/Auftrag/@rechnungseingang Beauftragung/Auftrag/Infos/Falldaten/Aufnahme/@tag Beauftragung/Auftrag/Infos/Verlegungen/@von</p>									
facets	<table border="1"> <thead> <tr> <th>Kind</th> <th>Value</th> <th>Annotation</th> </tr> </thead> <tbody> <tr> <td>minInclusive</td> <td>1850-01-01</td> <td></td> </tr> <tr> <td>maxInclusive</td> <td>2099-12-31</td> <td></td> </tr> </tbody> </table>	Kind	Value	Annotation	minInclusive	1850-01-01		maxInclusive	2099-12-31	
Kind	Value	Annotation								
minInclusive	1850-01-01									
maxInclusive	2099-12-31									
annotation	<p>documentation</p> <p>Datum im Format JJJJ-MM-TT</p>									
source	<pre><xs:simpleType name="Datum_Stp"> <xs:annotation> <xs:documentation>Datum im Format JJJJ-MM-TT</xs:documentation> </xs:annotation> <xs:restriction base="xs:date"> <xs:minInclusive value="1850-01-01"/> <xs:maxInclusive value="2099-12-31"/> </xs:restriction> </xs:simpleType></pre>									

simpleType Decimal_7_2_Stp

namespace	MD:xml-schema/MD-basis/3.5												
type	restriction of xs:decimal												
properties	base xs:decimal												
facets	<table border="1"> <thead> <tr> <th>Kind</th> <th>Value</th> <th>Annotation</th> </tr> </thead> <tbody> <tr> <td>maxExclusive</td> <td>100000</td> <td></td> </tr> <tr> <td>totalDigits</td> <td>7</td> <td></td> </tr> <tr> <td>fractionDigits</td> <td>2</td> <td></td> </tr> </tbody> </table>	Kind	Value	Annotation	maxExclusive	100000		totalDigits	7		fractionDigits	2	
Kind	Value	Annotation											
maxExclusive	100000												
totalDigits	7												
fractionDigits	2												
annotation	<p>documentation</p> <p>bis zu 7-stellig mit 2 Nachkommastellen, Maximalwert 99999.99</p>												
source	<pre><xs:simpleType name="Decimal_7_2_Stp"> <xs:annotation> <xs:documentation>bis zu 7-stellig mit 2 Nachkommastellen, Maximalwert</pre>												

	<pre> 99999.99</xs:documentation> </xs:annotation> <xs:restriction base="xs:decimal"> <xs:totalDigits value="7"/> <xs:fractionDigits value="2"/> <xs:maxExclusive value="100000"/> </xs:restriction> </xs:simpleType> </pre>
--	--

simpleType Decimal_8_2_Stp

namespace	MD:/xml-schema/MD-basis/3.5												
type	restriction of xs:decimal												
properties	base xs:decimal												
facets	<table border="1"> <thead> <tr> <th>Kind</th> <th>Value</th> <th>Annotation</th> </tr> </thead> <tbody> <tr> <td>maxExclusive</td> <td>1000000</td> <td></td> </tr> <tr> <td>totalDigits</td> <td>8</td> <td></td> </tr> <tr> <td>fractionDigits</td> <td>2</td> <td></td> </tr> </tbody> </table>	Kind	Value	Annotation	maxExclusive	1000000		totalDigits	8		fractionDigits	2	
Kind	Value	Annotation											
maxExclusive	1000000												
totalDigits	8												
fractionDigits	2												
annotation	documentation bis zu 8-stellig mit 2 Nachkommastellen, Maximalwert 999999.99												
source	<pre> <xs:simpleType name="Decimal_8_2_Stp"> <xs:annotation> <xs:documentation>bis zu 8-stellig mit 2 Nachkommastellen, Maximalwert 999999.99</xs:documentation> </xs:annotation> <xs:restriction base="xs:decimal"> <xs:totalDigits value="8"/> <xs:fractionDigits value="2"/> <xs:maxExclusive value="1000000"/> </xs:restriction> </xs:simpleType> </pre>												

simpleType Decimal_8_3_Stp

namespace	MD:/xml-schema/MD-basis/3.5												
type	restriction of xs:decimal												
properties	base xs:decimal												
facets	<table border="1"> <thead> <tr> <th>Kind</th> <th>Value</th> <th>Annotation</th> </tr> </thead> <tbody> <tr> <td>maxExclusive</td> <td>100000</td> <td></td> </tr> <tr> <td>totalDigits</td> <td>8</td> <td></td> </tr> <tr> <td>fractionDigits</td> <td>3</td> <td></td> </tr> </tbody> </table>	Kind	Value	Annotation	maxExclusive	100000		totalDigits	8		fractionDigits	3	
Kind	Value	Annotation											
maxExclusive	100000												
totalDigits	8												
fractionDigits	3												
annotation	documentation bis zu 8-stellig mit 3 Nachkommastellen, Maximalwert 99999.999												
source	<pre> <xs:simpleType name="Decimal_8_3_Stp"> <xs:annotation> <xs:documentation>bis zu 8-stellig mit 3 Nachkommastellen, Maximalwert 99999.999</xs:documentation> </xs:annotation> </pre>												

	<pre> <xs:restriction base="xs:decimal"> <xs:totalDigits value="8"/> <xs:fractionDigits value="3"/> <xs:maxExclusive value="100000"/> </xs:restriction> </xs:simpleType> </pre>
--	---

simpleType Decimal_8_4_Stp

namespace	MD:/xml-schema/MD-basis/3.5												
type	restriction of xs:decimal												
properties	base xs:decimal												
facets	<table border="1"> <thead> <tr> <th>Kind</th> <th>Value</th> <th>Annotation</th> </tr> </thead> <tbody> <tr> <td>maxExclusive</td> <td>10000</td> <td></td> </tr> <tr> <td>totalDigits</td> <td>8</td> <td></td> </tr> <tr> <td>fractionDigits</td> <td>4</td> <td></td> </tr> </tbody> </table>	Kind	Value	Annotation	maxExclusive	10000		totalDigits	8		fractionDigits	4	
Kind	Value	Annotation											
maxExclusive	10000												
totalDigits	8												
fractionDigits	4												
annotation	documentation bis zu 8-stellig mit 4 Nachkommastellen, Maximalwert 9999.9999												
source	<pre> <xs:simpleType name="Decimal_8_4_Stp"> <xs:annotation> <xs:documentation>bis zu 8-stellig mit 4 Nachkommastellen, Maximalwert 9999.9999</xs:documentation> </xs:annotation> <xs:restriction base="xs:decimal"> <xs:totalDigits value="8"/> <xs:fractionDigits value="4"/> <xs:maxExclusive value="100000"/> </xs:restriction> </xs:simpleType> </pre>												

simpleType Diagnosensicherheit_Stp

namespace	MD:/xml-schema/MD-basis/3.5															
type	restriction of xs:string															
properties	base xs:string															
facets	<table border="1"> <thead> <tr> <th>Kind</th> <th>Value</th> <th>Annotation</th> </tr> </thead> <tbody> <tr> <td>enumeration</td> <td>A</td> <td></td> </tr> <tr> <td>enumeration</td> <td>Z</td> <td></td> </tr> <tr> <td>enumeration</td> <td>V</td> <td></td> </tr> <tr> <td>enumeration</td> <td>G</td> <td></td> </tr> </tbody> </table>	Kind	Value	Annotation	enumeration	A		enumeration	Z		enumeration	V		enumeration	G	
Kind	Value	Annotation														
enumeration	A															
enumeration	Z															
enumeration	V															
enumeration	G															
annotation	documentation TA301 Schlüssel 17: Diagnosensicherheit A = ausgeschlossene Diagnose Z = Verdachtsdiagnose V = (symptomloser) Zustand nach der betreffenden Diagnose G = gesicherte Diagnose															
source	<pre> <xs:simpleType name="Diagnosensicherheit_Stp"> </pre>															

	<pre> <xs:annotation> <xs:documentation>TA301 Schlüssel 17: Diagnosen sicherheit A = ausgeschlossene Diagnose Z = Verdachtsdiagnose V = (symptomloser) Zustand nach der betreffenden Diagnose G = gesicherte Diagnose </xs:documentation> </xs:annotation> <xs:restriction base="xs:string"> <xs:enumeration value="A"/> <xs:enumeration value="Z"/> <xs:enumeration value="V"/> <xs:enumeration value="G"/> </xs:restriction> </xs:simpleType> </pre>
--	--

simpleType Dok_Typ_Stp

namespace	MD/xml-schema/MD-basis/3.5																								
type	restriction of xs:string																								
properties	base xs:string																								
used by	attribute Dokument Ctp/@dok_typ																								
facets	<table border="1"> <thead> <tr> <th>Kind</th> <th>Value</th> <th>Annotation</th> </tr> </thead> <tbody> <tr><td>enumeration</td><td>01</td><td></td></tr> <tr><td>enumeration</td><td>02</td><td></td></tr> <tr><td>enumeration</td><td>03</td><td></td></tr> <tr><td>enumeration</td><td>04</td><td></td></tr> <tr><td>enumeration</td><td>05</td><td></td></tr> <tr><td>enumeration</td><td>06</td><td></td></tr> <tr><td>enumeration</td><td>99</td><td></td></tr> </tbody> </table>	Kind	Value	Annotation	enumeration	01		enumeration	02		enumeration	03		enumeration	04		enumeration	05		enumeration	06		enumeration	99	
Kind	Value	Annotation																							
enumeration	01																								
enumeration	02																								
enumeration	03																								
enumeration	04																								
enumeration	05																								
enumeration	06																								
enumeration	99																								
annotation	<pre> documentation Schlüssel Dokument Typ 01 Gutachten 02 Beurteilung RV-Pflicht (nur für DA SPV MD) 03 Präventions- und Reha-Empfehlung (nur für DA SPV MD) 04 Hilfsmittelempfehlung (nur für DA SPV MD) 05 Formular § 51 SGB V (nur für DA MD AU/KG) 06 Schweigepflichtentbindung (nur für DA MD AU/KG/Reha) 99 Sonstige Dokumente </pre>																								
source	<pre> <xs:simpleType name="Dok_Typ_Stp"> <xs:annotation> <xs:documentation>Schlüssel Dokument Typ 01 Gutachten 02 Beurteilung RV-Pflicht (nur für DA SPV MD) 03 Präventions- und Reha-Empfehlung (nur für DA SPV MD) 04 Hilfsmittelempfehlung (nur für DA SPV MD) 05 Formular § 51 SGB V (nur für DA MD AU/KG) 06 Schweigepflichtentbindung (nur für DA MD AU/KG/Reha) 99 Sonstige Dokumente </pre>																								

	<pre> </xs:documentation> </xs:annotation> <xs:restriction base="xs:string"> <xs:enumeration value="01"/> <xs:enumeration value="02"/> <xs:enumeration value="03"/> <xs:enumeration value="04"/> <xs:enumeration value="05"/> <xs:enumeration value="06"/> <xs:enumeration value="99"/> </xs:restriction> </xs:simpleType> </pre>
--	---

simpleType Email_Stp

namespace	MD:/xml-schema/MD-basis/3.5												
type	restriction of G14X-basis:EmailAdresse_Stp												
properties	base G14X-basis:EmailAdresse_Stp												
used by	elements Kontaktdaten_Ctp/Email_Adressat_Oder_Adresse_Ctp/Kontakt/Email_Arzt_Ctp/Kontakt/Email_Kasse_Ctp/Kontakt/Email_Leistungserbringer_Ctp/Kontakt/Email_MD_Ctp/Kontakt/Email_Versicherter_Ctp/Kontakt/Email												
facets	<table border="1"> <thead> <tr> <th>Kind</th> <th>Value</th> <th>Annotation</th> </tr> </thead> <tbody> <tr> <td>minLength</td> <td>1</td> <td></td> </tr> <tr> <td>maxLength</td> <td>50</td> <td></td> </tr> <tr> <td>pattern</td> <td>[_\\-a-zA-Z0-9\\.\\+]+@[a-zA-Z0-9](\\.?[\\-a-zA-Z0-9]*[a-zA-Z0-9])*</td> <td></td> </tr> </tbody> </table>	Kind	Value	Annotation	minLength	1		maxLength	50		pattern	[_\\-a-zA-Z0-9\\.\\+]+@[a-zA-Z0-9](\\.?[\\-a-zA-Z0-9]*[a-zA-Z0-9])*	
Kind	Value	Annotation											
minLength	1												
maxLength	50												
pattern	[_\\-a-zA-Z0-9\\.\\+]+@[a-zA-Z0-9](\\.?[\\-a-zA-Z0-9]*[a-zA-Z0-9])*												
annotation	documentation Email Adresse												
source	<pre> <xs:simpleType name="Email_Stp"> <xs:annotation> <xs:documentation>Email Adresse</xs:documentation> </xs:annotation> <xs:restriction base="G14X-basis:EmailAdresse_Stp"> <xs:maxLength value="50"/> <xs:pattern value="[_\\-a-zA-Z0-9\\.\\+]+@[a-zA-Z0-9](\\.?[\\-a-zA-Z0-9]*[a-zA-Z0-9])*" /> </xs:restriction> </xs:simpleType> </pre>												

simpleType Entgeltart_Stp

namespace	MD:/xml-schema/MD-basis/3.5									
type	restriction of xs:string									
properties	base xs:string									
facets	<table border="1"> <thead> <tr> <th>Kind</th> <th>Value</th> <th>Annotation</th> </tr> </thead> <tbody> <tr> <td>length</td> <td>8</td> <td></td> </tr> <tr> <td>pattern</td> <td>[0-9A-Z]</td> <td></td> </tr> </tbody> </table>	Kind	Value	Annotation	length	8		pattern	[0-9A-Z]	
Kind	Value	Annotation								
length	8									
pattern	[0-9A-Z]									
annotation	documentation TA301 Schlüssel 4: Entgeltarten									

source	<pre> <xs:simpleType name="Entgeltart_Stp"> <xs:annotation> <xs:documentation>TA301 Schlüssel 4: Entgeltarten</xs:documentation> </xs:annotation> <xs:restriction base="xs:string"> <xs:length value="8" /> <xs:pattern value="[0-9A-Z]" /> </xs:restriction> </xs:simpleType> </pre>
--------	---

simpleType Entlassungsgrund_Stp

namespace	MD:/xml-schema/MD-basis/3.5									
type	restriction of xs:string									
properties	base xs:string									
facets	<table border="1"> <thead> <tr> <th>Kind</th> <th>Value</th> <th>Annotation</th> </tr> </thead> <tbody> <tr> <td>length</td> <td>3</td> <td></td> </tr> <tr> <td>pattern</td> <td>[0-9]</td> <td></td> </tr> </tbody> </table>	Kind	Value	Annotation	length	3		pattern	[0-9]	
Kind	Value	Annotation								
length	3									
pattern	[0-9]									
annotation	documentation TA301 Schlüssel 5: Entlassungs-/Verlegungsgrund									
source	<pre> <xs:simpleType name="Entlassungsgrund_Stp"> <xs:annotation> <xs:documentation>TA301 Schlüssel 5: Entlassungs-/Verlegungsgrund</xs:documentation> </xs:annotation> <xs:restriction base="xs:string"> <xs:length value="3" /> <xs:pattern value="[0-9]" /> </xs:restriction> </xs:simpleType> </pre>									

simpleType Fachabteilung_Stp

namespace	MD:/xml-schema/MD-basis/3.5									
type	restriction of xs:string									
properties	base xs:string									
facets	<table border="1"> <thead> <tr> <th>Kind</th> <th>Value</th> <th>Annotation</th> </tr> </thead> <tbody> <tr> <td>length</td> <td>4</td> <td></td> </tr> <tr> <td>pattern</td> <td>[0-9]</td> <td></td> </tr> </tbody> </table>	Kind	Value	Annotation	length	4		pattern	[0-9]	
Kind	Value	Annotation								
length	4									
pattern	[0-9]									
annotation	documentation TA301 Schlüssel 6: Fachabteilungen									
source	<pre> <xs:simpleType name="Fachabteilung_Stp"> <xs:annotation> <xs:documentation>TA301 Schlüssel 6: Fachabteilungen</xs:documentation> </xs:annotation> <xs:restriction base="xs:string"> <xs:length value="4" /> <xs:pattern value="[0-9]" /> </xs:restriction> </pre>									

	<pre></xs:restriction> </xs:simpleType></pre>
--	---

simpleType Facharztbezeichnung_Stp

namespace	MD:/xml-schema/MD-basis/3.5												
type	restriction of Char30_Stp												
properties	base Char30_Stp												
used by	element Arzt_Ctp/Facharztbezeichnung												
facets	<table border="1"> <thead> <tr> <th>Kind</th> <th>Value</th> <th>Annotation</th> </tr> </thead> <tbody> <tr> <td>minLength</td> <td>1</td> <td></td> </tr> <tr> <td>maxLength</td> <td>30</td> <td></td> </tr> <tr> <td>pattern</td> <td>\S+ [&#x0020;-&#x00FF;]*</td> <td></td> </tr> </tbody> </table>	Kind	Value	Annotation	minLength	1		maxLength	30		pattern	\S+ [-ÿ]*	
Kind	Value	Annotation											
minLength	1												
maxLength	30												
pattern	\S+ [-ÿ]*												
annotation	documentation Facharztbezeichnung												
source	<pre><xs:simpleType name="Facharztbezeichnung_Stp"> <xs:annotation> <xs:documentation>Facharztbezeichnung</xs:documentation> </xs:annotation> <xs:restriction base="Char30_Stp"> <xs:minLength value="1"/> </xs:restriction> </xs:simpleType></pre>												

simpleType Fallnummer_Stp

namespace	MD:/xml-schema/MD-basis/3.5												
type	restriction of Char50_Stp												
properties	base Char50_Stp												
used by	elements Aktenzeichen anderer Begutachtungsfall_Ctp/Fallnummer Kasse_Ctp/Fallnummer												
facets	<table border="1"> <thead> <tr> <th>Kind</th> <th>Value</th> <th>Annotation</th> </tr> </thead> <tbody> <tr> <td>minLength</td> <td>1</td> <td></td> </tr> <tr> <td>maxLength</td> <td>50</td> <td></td> </tr> <tr> <td>pattern</td> <td>\S+ [&#x0020;-&#x00FF;]*</td> <td></td> </tr> </tbody> </table>	Kind	Value	Annotation	minLength	1		maxLength	50		pattern	\S+ [-ÿ]*	
Kind	Value	Annotation											
minLength	1												
maxLength	50												
pattern	\S+ [-ÿ]*												
annotation	documentation Fallnummer der Krankenkasse												
source	<pre><xs:simpleType name="Fallnummer_Stp"> <xs:annotation> <xs:documentation>Fallnummer der Krankenkasse</xs:documentation> </xs:annotation> <xs:restriction base="Char50_Stp"> <xs:minLength value="1"/> </xs:restriction> </xs:simpleType></pre>												

simpleType Freitext_Mit_Buchstaben_Stp

namespace	MD:/xml-schema/MD-basis/3.5												
type	restriction of Freitext Mit Zeichen Stp												
properties	base Freitext_Mit_Zeichen_Stp												
facets	<table border="1"> <thead> <tr> <th>Kind</th> <th>Value</th> <th>Annotation</th> </tr> </thead> <tbody> <tr> <td>minLength</td> <td>1</td> <td></td> </tr> <tr> <td>maxLength</td> <td>255</td> <td></td> </tr> <tr> <td>pattern</td> <td>.*[\p{L}].*</td> <td></td> </tr> </tbody> </table>	Kind	Value	Annotation	minLength	1		maxLength	255		pattern	.*[\p{L}].*	
Kind	Value	Annotation											
minLength	1												
maxLength	255												
pattern	.*[\p{L}].*												
annotation	documentation Freitext mit mindestens einem Buchstaben. Enthält Zeilenumbrüche (CR/LF) und Tab.												
source	<pre><xs:simpleType name="Freitext_Mit_Buchstaben_Stp"> <xs:annotation> <xs:documentation>Freitext mit mindestens einem Buchstaben. Enthält Zeilenumbrüche (CR/LF) und Tab.</xs:documentation> </xs:annotation> <xs:restriction base="Freitext_Mit_Zeichen_Stp"> <xs:pattern value=".*[\p{L}].*" /> </xs:restriction> </xs:simpleType></pre>												

simpleType Freitext_Mit_Zeichen_Stp

namespace	MD:/xml-schema/MD-basis/3.5									
type	restriction of xs:string									
properties	base xs:string									
used by	<table border="1"> <thead> <tr> <th>simpleType</th> <th>attributes</th> </tr> </thead> <tbody> <tr> <td>Freitext Mit Buchstaben Stp</td> <td></td> </tr> <tr> <td>Beauftragung/Auftrag/@anlagen_post_text</td> <td>Begutachtung/Stellungnahme/@anlagen_post_text</td> </tr> <tr> <td>Beauftragung/Auftrag/@unterlagen_beiMD_text</td> <td></td> </tr> </tbody> </table>	simpleType	attributes	Freitext Mit Buchstaben Stp		Beauftragung/Auftrag/@anlagen_post_text	Begutachtung/Stellungnahme/@anlagen_post_text	Beauftragung/Auftrag/@unterlagen_beiMD_text		
simpleType	attributes									
Freitext Mit Buchstaben Stp										
Beauftragung/Auftrag/@anlagen_post_text	Begutachtung/Stellungnahme/@anlagen_post_text									
Beauftragung/Auftrag/@unterlagen_beiMD_text										
facets	<table border="1"> <thead> <tr> <th>Kind</th> <th>Value</th> <th>Annotation</th> </tr> </thead> <tbody> <tr> <td>minLength</td> <td>1</td> <td></td> </tr> <tr> <td>maxLength</td> <td>255</td> <td></td> </tr> </tbody> </table>	Kind	Value	Annotation	minLength	1		maxLength	255	
Kind	Value	Annotation								
minLength	1									
maxLength	255									
annotation	documentation Eine Zeichenkette, die Zeichen aus dem Zeichensatz ISO-8859-1 mit Zeilenumbrüche (CR/LF) und Tab enthält.									
source	<pre><xs:simpleType name="Freitext_Mit_Zeichen_Stp"> <xs:annotation> <xs:documentation>Eine Zeichenkette, die Zeichen aus dem Zeichensatz ISO-8859-1 mit Zeilenumbrüche (CR/LF) und Tab enthält.</xs:documentation> </xs:annotation> <xs:restriction base="xs:string"> <xs:minLength value="1" /> <xs:maxLength value="255" /> </xs:restriction> </xs:simpleType></pre>									

simpleType Freitext_Mit_Zeilenum_10000_Stp

namespace	MD:/xml-schema/MD-basis/3.5
-----------	-----------------------------

type	restriction of xs:string									
properties	base xs:string									
facets	<table border="1"> <thead> <tr> <th>Kind</th> <th>Value</th> <th>Annotation</th> </tr> </thead> <tbody> <tr> <td>maxLength</td> <td>10000</td> <td></td> </tr> <tr> <td>pattern</td> <td>\S+[\n\r\t&#x0020;-&#x00FF;]*</td> <td></td> </tr> </tbody> </table>	Kind	Value	Annotation	maxLength	10000		pattern	\S+[\n\r\t -ÿ]*	
Kind	Value	Annotation								
maxLength	10000									
pattern	\S+[\n\r\t -ÿ]*									
annotation	<p>documentation</p> <p>Eine Zeichenkette, die Zeichen aus dem Zeichensatz ISO-8859-1 mit Zeilenumbrüche (CR/LF) und Tab enthält.</p>									
source	<pre><xs:simpleType name="Frei text_Mit_Zeilenenum_10000_Stp"> <xs:annotation> <xs:documentation>Ei ne Zei chenket te, di e Zei chen aus dem Zei chensatz I S0-8859-1 mit Zei lenumbrü che (CR/LF) und Tab enth ält t. </xs:documentation> </xs:annotation> <xs:restriction base="xs:string"> <xs:maxLength value="10000"/> <xs:pattern value="\S+[\n\r\t&#x0020;-&#x00FF;]*" /> </xs:restriction> </xs:simpleType></pre>									

simpleType Freitext_Mit_Zeilenenum_1000_Stp

namespace	MD:/xml-schema/MD-basis/3.5									
type	restriction of xs:string									
properties	base xs:string									
used by	<p>elements</p> <p>Person_Ctp/Erl_bes_schutz_Person_Adressat_Oder_Adresse_Ctp/Person/Erl_bes_schutz_Person Arzt_Ctp/Person/Erl_bes_schutz_Person_Versicherter_Ctp/Person/Erl_bes_schutz_Person</p>									
facets	<table border="1"> <thead> <tr> <th>Kind</th> <th>Value</th> <th>Annotation</th> </tr> </thead> <tbody> <tr> <td>maxLength</td> <td>1000</td> <td></td> </tr> <tr> <td>pattern</td> <td>\S+[\n\r\t&#x0020;-&#x00FF;]*</td> <td></td> </tr> </tbody> </table>	Kind	Value	Annotation	maxLength	1000		pattern	\S+[\n\r\t -ÿ]*	
Kind	Value	Annotation								
maxLength	1000									
pattern	\S+[\n\r\t -ÿ]*									
annotation	<p>documentation</p> <p>Eine Zeichenkette, die Zeichen aus dem Zeichensatz ISO-8859-1 mit Zeilenumbrüche (CR/LF) und Tab enthält.</p>									
source	<pre><xs:simpleType name="Frei text_Mit_Zeilenenum_1000_Stp"> <xs:annotation> <xs:documentation>Ei ne Zei chenket te, di e Zei chen aus dem Zei chensatz I S0-8859-1 mit Zei lenumbrü che (CR/LF) und Tab enth ält t. </xs:documentation> </xs:annotation> <xs:restriction base="xs:string"> <xs:maxLength value="1000"/> <xs:pattern value="\S+[\n\r\t&#x0020;-&#x00FF;]*" /> </xs:restriction> </xs:simpleType></pre>									

simpleType Freitext_Mit_Zeilenumbrueche_Stp

namespace	MD:/xml-schema/MD-basis/3.5
type	restriction of xs:string
properties	base xs:string
used by	<p>element</p> <p>Adressat_Oder_Adresse_Ctp/Besondere_Hinweise</p>

facets	Kind maxLength 255 pattern \S+[\n\r\t -ÿ]*	Value	Annotation
annotation	documentation Eine Zeichenkette, die Zeichen aus dem Zeichensatz ISO-8859-1 mit Zeilenumbrüche (CR/LF) und Tab enthält.		
source	<pre><xs:simpleType name="Frei text_Mi t_Zei lenumbrueche_Stp"> <xs:annotation> <xs:documentation>Ei ne Zei chenkette, di e Zei chen aus dem Zei chensatz I S0-8859-1 mi t Zei lenumbrüche (CR/LF) und Tab enthäl t.</xs:documentation> </xs:annotation> <xs:restriction base="xs:string"> <xs:maxLength value="255"/> <xs:pattern value="\S+[\n\r\t&#x0020;-&#x00FF;]*" /> </xs:restriction> </xs:simpleType></pre>		

simpleType Freitext_Ohne_Zeilenumbrueche_Stp

namespace	MD:/xml-schema/MD-basis/3.5		
type	restriction of xs:string		
properties	base xs:string		
used by	simpleTypes	Char10_Stp Char20_Stp Char25_Stp Char28_Stp Char30_Stp Char50_Stp Char80_Stp	
	attributes	Dokument_Ctp/@mime_type Dokument_Ctp/@name	
facets	Kind maxLength 255 pattern \S+[\ -ÿ]*	Value	Annotation
annotation	documentation Eine Zeichenkette, die Zeichen aus dem Zeichensatz ISO-8859-1 ohne Zeilenumbrüche (CR/LF) und Tab enthält.		
source	<pre><xs:simpleType name="Frei text_Ohne_Zei lenumbrueche_Stp"> <xs:annotation> <xs:documentation>Ei ne Zei chenkette, di e Zei chen aus dem Zei chensatz I S0-8859-1 ohne Zei lenumbrüche (CR/LF) und Tab enthäl t.</xs:documentation> </xs:annotation> <xs:restriction base="xs:string"> <xs:maxLength value="255"/> <xs:pattern value="\S+[\&#x0020;-&#x00FF;]*" /> </xs:restriction> </xs:simpleType></pre>		

simpleType Gen_Geburtsdatum_Stp

namespace	MD:/xml-schema/MD-basis/3.5		
type	restriction of xs:integer		
properties	base xs:integer		
used by	elements	Person_Ctp/Genauigkeit_Geburtsdatum Adressat Oder Adresse_Ctp/Person/Genauigkeit_Geburtsdatum Arzt_Ctp/Person/Genauigkeit_Geburtsdatum_Versicherter_Ctp/Person/Genauigkeit_Geburtsdatum	
facets	Kind enumeration 1	Value	Annotation

	enumeration 2
annotation	documentation Kein Eintrag = taggenau 1 = monatsgenau 2 = jahrgenau
source	<pre> <xs:simpleType name="Gen_Geburtsdatum_Stp"> <xs:annotation> <xs:documentation> Kein Eintrag = taggenau 1 = monatsgenau 2 = jahrgenau </xs:documentation> </xs:annotation> <xs:restriction base="xs:integer"> <xs:enumeration value="1"/> <xs:enumeration value="2"/> </xs:restriction> </xs:simpleType> </pre>

simpleType Geschlecht_Stp

namespace	MD:/xml-schema/MD-basis/3.5															
type	restriction of xs:string															
properties	base xs:string															
used by	elements Person_Ctp/Geschlecht Adressat_Oder_Adresse_Ctp/Person/Geschlecht Arzt_Ctp/Person/Geschlecht Versicherter_Ctp/Person/Geschlecht															
facets	<table border="1"> <thead> <tr> <th>Kind</th> <th>Value</th> <th>Annotation</th> </tr> </thead> <tbody> <tr> <td>enumeration</td> <td>m</td> <td></td> </tr> <tr> <td>enumeration</td> <td>w</td> <td></td> </tr> <tr> <td>enumeration</td> <td>x</td> <td></td> </tr> <tr> <td>enumeration</td> <td>d</td> <td></td> </tr> </tbody> </table>	Kind	Value	Annotation	enumeration	m		enumeration	w		enumeration	x		enumeration	d	
Kind	Value	Annotation														
enumeration	m															
enumeration	w															
enumeration	x															
enumeration	d															
annotation	documentation TA301 Schlüssel 21: Geschlecht m = männlich w = weiblich x = unbestimmt d = divers															
source	<pre> <xs:simpleType name="Geschlecht_Stp"> <xs:annotation> <xs:documentation>TA301 Schlüssel 21: Geschlecht m = männlich w = weiblich x = unbestimmt d = divers </xs:documentation> </xs:annotation> <xs:restriction base="xs:string"> <xs:enumeration value="m"/> </pre>															

	<pre> <xs:enumeration value="w"/> <xs:enumeration value="x"/> <xs:enumeration value="d"/> </xs:restriction> </xs:simpleType> </pre>
--	---

simpleType ICD_Schluessel_Stp

namespace	MD:/xml-schema/MD-basis/3.5												
type	restriction of xs:string												
properties	base xs:string												
used by	attributes Beauftragung/Auftrag/Infos/Diagnosen/Diagnose/@icd Begutachtung/Stellungnahme/Pruefung/Diagnosen/Diagnose/KH/@icd Begutachtung/Stellungnahme/Pruefung/Diagnosen/Diagnose/MD/@icd												
facets	<table border="1"> <thead> <tr> <th>Kind</th> <th>Value</th> <th>Annotation</th> </tr> </thead> <tbody> <tr> <td>minLength</td> <td>3</td> <td></td> </tr> <tr> <td>maxLength</td> <td>9</td> <td></td> </tr> <tr> <td>pattern</td> <td>(\p{L}\p{N}\p{N}.*)?</td> <td></td> </tr> </tbody> </table>	Kind	Value	Annotation	minLength	3		maxLength	9		pattern	(\p{L}\p{N}\p{N}.*)?	
Kind	Value	Annotation											
minLength	3												
maxLength	9												
pattern	(\p{L}\p{N}\p{N}.*)?												
annotation	documentation ICD-Schlüssel												
source	<pre> <xs:simpleType name="ICD_Schl uessel _Stp"> <xs:annotation> <xs:documentation>ICD-Schl üssel </xs:documentation> </xs:annotation> <xs:restriction base="xs:string"> <xs:minLength value="3"/> <xs:maxLength value="9"/> <xs:pattern value="(\p{L}\p{N}\p{N}.*)?"/> </xs:restriction> </xs:simpleType> </pre>												

simpleType ICD_Version_Stp

namespace	MD:/xml-schema/MD-basis/3.5									
type	restriction of xs:gYear									
properties	base xs:gYear									
facets	<table border="1"> <thead> <tr> <th>Kind</th> <th>Value</th> <th>Annotation</th> </tr> </thead> <tbody> <tr> <td>minInclusive</td> <td>2003</td> <td></td> </tr> <tr> <td>maxInclusive</td> <td>2099</td> <td></td> </tr> </tbody> </table>	Kind	Value	Annotation	minInclusive	2003		maxInclusive	2099	
Kind	Value	Annotation								
minInclusive	2003									
maxInclusive	2099									
annotation	documentation ICD Version									
source	<pre> <xs:simpleType name="ICD_Versi on_Stp"> <xs:annotation> <xs:documentation>ICD Versi on</xs:documentation> </xs:annotation> <xs:restriction base="xs:gYear"> <xs:minIncl usi ve value="2003"/> <xs:maxIncl usi ve value="2099"/> </xs:restriction> </xs:simpleType> </pre>									

	<pre></xs:restriction> </xs:simpleType></pre>
--	---

simpleType IK_Stp

namespace	MD:/xml-schema/MD-basis/3.5												
type	restriction of G14X-basis:IK_Stp												
properties	base G14X-basis:IK_Stp												
used by	elements Identifikationsmerkmal_Ctp/IK_Kasse_Ctp/IK_Leistungserbringer_Ctp/IK_MD_Ctp/IK_vkz_Grp/@ik_absender vkz_Grp/@ik_empfaenger												
facets	<table border="1"> <thead> <tr> <th>Kind</th> <th>Value</th> <th>Annotation</th> </tr> </thead> <tbody> <tr> <td>minLength</td> <td>9</td> <td></td> </tr> <tr> <td>maxLength</td> <td>9</td> <td></td> </tr> <tr> <td>pattern</td> <td>[1-9][0-9]+</td> <td></td> </tr> </tbody> </table>	Kind	Value	Annotation	minLength	9		maxLength	9		pattern	[1-9][0-9]+	
Kind	Value	Annotation											
minLength	9												
maxLength	9												
pattern	[1-9][0-9]+												
annotation	documentation Das Institutionskennzeichen. Das IK besteht aus 9 Ziffern, keine führende 0.												
source	<pre><xs:simpleType name="IK_Stp"> <xs:annotation> <xs:documentation>Das Institutionskennzeichen. Das IK besteht aus 9 Ziffern, keine führende 0.</xs:documentation> </xs:annotation> <xs:restriction base="G14X-basis:IK_Stp"> <xs:pattern value="[1-9][0-9]+" /> </xs:restriction> </xs:simpleType></pre>												

simpleType Int10_Stp

namespace	MD:/xml-schema/MD-basis/3.5						
type	restriction of xs:integer						
properties	base xs:integer						
facets	<table border="1"> <thead> <tr> <th>Kind</th> <th>Value</th> <th>Annotation</th> </tr> </thead> <tbody> <tr> <td>pattern</td> <td>[0-9]{1,10}</td> <td></td> </tr> </tbody> </table>	Kind	Value	Annotation	pattern	[0-9]{1,10}	
Kind	Value	Annotation					
pattern	[0-9]{1,10}						
annotation	documentation maximal zehnstellig numerisch						
source	<pre><xs:simpleType name="Int10_Stp"> <xs:annotation> <xs:documentation>maximal zehnstellig numerisch</xs:documentation> </xs:annotation> <xs:restriction base="xs:integer"> <xs:pattern value="[0-9]{1,10}" /> </xs:restriction> </xs:simpleType></pre>						

simpleType Int1_Stp

namespace	MD:/xml-schema/MD-basis/3.5
-----------	-----------------------------

type	restriction of xs:integer
properties	base xs:integer
facets	Kind Value Annotation pattern [0-9]
annotation	documentation einstellig numerisch
source	<pre><xs:simpleType name="Int1_Stp"> <xs:annotation> <xs:documentation>einstellig numerisch</xs:documentation> </xs:annotation> <xs:restriction base="xs:integer"> <xs:pattern value="[0-9]"/> </xs:restriction> </xs:simpleType></pre>

simpleType Int2_Stp

namespace	MD/xml-schema/MD-basis/3.5
type	restriction of xs:integer
properties	base xs:integer
used by	simpleType KZV Bereich Stp
facets	Kind Value Annotation pattern [0-9]{1,2}
annotation	documentation maximal zweistellig numerisch
source	<pre><xs:simpleType name="Int2_Stp"> <xs:annotation> <xs:documentation>maximal zweistellig numerisch</xs:documentation> </xs:annotation> <xs:restriction base="xs:integer"> <xs:pattern value="[0-9]{1,2}"/> </xs:restriction> </xs:simpleType></pre>

simpleType Int3_Stp

namespace	MD/xml-schema/MD-basis/3.5
type	restriction of xs:integer
properties	base xs:integer
facets	Kind Value Annotation pattern [0-9]{1,3}
annotation	documentation maximal dreistellig numerisch
source	<pre><xs:simpleType name="Int3_Stp"> <xs:annotation> <xs:documentation>maximal dreistellig numerisch</xs:documentation> </xs:annotation></pre>

	<pre><xs:restriction base="xs:integer"> <xs:pattern value="[0-9]{1,3}"/> </xs:restriction> </xs:simpleType></pre>
--	---

simpleType Int4_Stp

namespace	MD:/xml-schema/MD-basis/3.5						
type	restriction of xs:integer						
properties	base xs:integer						
facets	<table border="1"> <thead> <tr> <th>Kind</th> <th>Value</th> <th>Annotation</th> </tr> </thead> <tbody> <tr> <td>pattern</td> <td>[0-9]{1,4}</td> <td></td> </tr> </tbody> </table>	Kind	Value	Annotation	pattern	[0-9]{1,4}	
Kind	Value	Annotation					
pattern	[0-9]{1,4}						
annotation	documentation maximal vierstellig numerisch						
source	<pre><xs:simpleType name="Int4_Stp"> <xs:annotation> <xs:documentation>maximal vierstellig numerisch</xs:documentation> </xs:annotation> <xs:restriction base="xs:integer"> <xs:pattern value="[0-9]{1,4}"/> </xs:restriction> </xs:simpleType></pre>						

simpleType Int5_Stp

namespace	MD:/xml-schema/MD-basis/3.5						
type	restriction of xs:integer						
properties	base xs:integer						
facets	<table border="1"> <thead> <tr> <th>Kind</th> <th>Value</th> <th>Annotation</th> </tr> </thead> <tbody> <tr> <td>pattern</td> <td>[0-9]{1,5}</td> <td></td> </tr> </tbody> </table>	Kind	Value	Annotation	pattern	[0-9]{1,5}	
Kind	Value	Annotation					
pattern	[0-9]{1,5}						
annotation	documentation maximal fünfstellig numerisch						
source	<pre><xs:simpleType name="Int5_Stp"> <xs:annotation> <xs:documentation>maximal fünfstellig numerisch</xs:documentation> </xs:annotation> <xs:restriction base="xs:integer"> <xs:pattern value="[0-9]{1,5}"/> </xs:restriction> </xs:simpleType></pre>						

simpleType Int7_Stp

namespace	MD:/xml-schema/MD-basis/3.5
type	restriction of xs:integer
properties	base xs:integer

facets	Kind Value Annotation pattern [0-9]{1,7}
annotation	documentation maximal siebenstellig numerisch
source	<pre><xs:simpleType name="Int7_Stp"> <xs:annotation> <xs:documentation>maximal siebenstellig numerisch</xs:documentation> </xs:annotation> <xs:restriction base="xs:integer"> <xs:pattern value="[0-9]{1,7}"/> </xs:restriction> </xs:simpleType></pre>

simpleType Int8_Stp

namespace	MD:/xml-schema/MD-basis/3.5
type	restriction of xs:integer
properties	base xs:integer
facets	Kind Value Annotation pattern [0-9]{1,8}
annotation	documentation maximal achtstellig numerisch
source	<pre><xs:simpleType name="Int8_Stp"> <xs:annotation> <xs:documentation>maximal achtstellig numerisch</xs:documentation> </xs:annotation> <xs:restriction base="xs:integer"> <xs:pattern value="[0-9]{1,8}"/> </xs:restriction> </xs:simpleType></pre>

simpleType Ja_Nein_Stp

namespace	MD:/xml-schema/MD-basis/3.5
type	restriction of xs:integer
properties	base xs:integer
facets	Kind Value Annotation enumeration 0 enumeration 1
annotation	documentation 0 = nein 1 = ja
source	<pre><xs:simpleType name="Ja_Nein_Stp"> <xs:annotation> <xs:documentation> 0 = nein 1 = ja </xs:documentation> </xs:annotation> <xs:restriction base="xs:integer"> <xs:enumeration value="0"/> <xs:enumeration value="1"/> </xs:restriction> </xs:simpleType></pre>

	<pre> 1 = ja </xs:documentation> </xs:annotation> <xs:restriction base="xs:integer"> <xs:enumeration value="0"/> <xs:enumeration value="1"/> </xs:restriction> </xs:simpleType> </pre>
--	--

simpleType Ja_Unbekannt_Stp

namespace	MD:/xml-schema/MD-basis/3.5									
type	restriction of xs:integer									
properties	base xs:integer									
facets	<table border="1"> <thead> <tr> <th>Kind</th> <th>Value</th> <th>Annotation</th> </tr> </thead> <tbody> <tr> <td>enumeration</td> <td>0</td> <td></td> </tr> <tr> <td>enumeration</td> <td>1</td> <td></td> </tr> </tbody> </table>	Kind	Value	Annotation	enumeration	0		enumeration	1	
Kind	Value	Annotation								
enumeration	0									
enumeration	1									
annotation	documentation 0 = unbekannt 1 = ja									
source	<pre> <xs:simpleType name="Ja_Unbekannt_Stp"> <xs:annotation> <xs:documentation> 0 = unbekannt 1 = ja </xs:documentation> </xs:annotation> <xs:restriction base="xs:integer"> <xs:enumeration value="0"/> <xs:enumeration value="1"/> </xs:restriction> </xs:simpleType> </pre>									

simpleType KV_PV_Nummer_Stp

namespace	MD:/xml-schema/MD-basis/3.5												
type	restriction of Char20_Stp												
properties	base Char20_Stp												
used by	element Versicherter Ctp/KV_PV_Nummer												
facets	<table border="1"> <thead> <tr> <th>Kind</th> <th>Value</th> <th>Annotation</th> </tr> </thead> <tbody> <tr> <td>minLength</td> <td>1</td> <td></td> </tr> <tr> <td>maxLength</td> <td>15</td> <td></td> </tr> <tr> <td>pattern</td> <td>\S+ [&#x0020;-&#x00FF;]*</td> <td></td> </tr> </tbody> </table>	Kind	Value	Annotation	minLength	1		maxLength	15		pattern	\S+ [-ÿ]*	
Kind	Value	Annotation											
minLength	1												
maxLength	15												
pattern	\S+ [-ÿ]*												
annotation	documentation Kranken-/Pflegeversichertennummer												

source	<pre> <xs:simpleType name="KV_PV_Nummer_Stp"> <xs:annotation> <xs:documentation>Kranken-/Pfl egeversischer tennummer</xs:documentation> </xs:annotation> <xs:restriction base="Char20_Stp"> <xs:minLength value="1"/> <xs:maxLength value="15"/> </xs:restriction> </xs:simpleType> </pre>
--------	--

simpleType KZV_Bereich_Stp

namespace	MD:/xml-schema/MD-basis/3.5						
type	restriction of Int2_Stp						
properties	base Int2_Stp						
used by	element Identifikationsmerkmal_Ctp/KZV_Bereich						
facets	<table border="0"> <tr> <td>Kind</td> <td>Value</td> <td>Annotation</td> </tr> <tr> <td>pattern</td> <td>[0-9]{2}</td> <td></td> </tr> </table>	Kind	Value	Annotation	pattern	[0-9]{2}	
Kind	Value	Annotation					
pattern	[0-9]{2}						
annotation	documentation KZV-Bereich des Zahnarztes						
source	<pre> <xs:simpleType name="KZV_Bereich_Stp"> <xs:annotation> <xs:documentation>KZV-Bereich des Zahnarztes</xs:documentation> </xs:annotation> <xs:restriction base="Int2_Stp"> <xs:pattern value="[0-9]{2}"/> </xs:restriction> </xs:simpleType> </pre>						

simpleType LANR_Stp

namespace	MD:/xml-schema/MD-basis/3.5												
type	GI4X-basis:LANR_Stp												
properties	base GI4X-basis:LANR_Stp												
used by	element Identifikationsmerkmal_Ctp/LANR												
facets	<table border="0"> <tr> <td>Kind</td> <td>Value</td> <td>Annotation</td> </tr> <tr> <td>minLength</td> <td>9</td> <td></td> </tr> <tr> <td>maxLength</td> <td>9</td> <td></td> </tr> <tr> <td>pattern</td> <td>[0-9]+</td> <td></td> </tr> </table>	Kind	Value	Annotation	minLength	9		maxLength	9		pattern	[0-9]+	
Kind	Value	Annotation											
minLength	9												
maxLength	9												
pattern	[0-9]+												
annotation	documentation Die lebenslange Arztnummer. Die LANR besteht aus 9 Ziffern, keine führende 0.												
source	<pre> <xs:simpleType name="LANR_Stp"> <xs:annotation> <xs:documentation>Die lebenslange Arztnummer. Die LANR besteht aus 9 Ziffern, keine führende 0.</xs:documentation> </xs:annotation> <xs:restriction base="GI4X-basis:LANR_Stp"/> </pre>												

	<code></xs:simpleType></code>
--	-------------------------------------

simpleType LKZ_Stp

namespace	MD:/xml-schema/MD-basis/3.5												
type	GI4X-basis:Laenderkennzeichen Stp												
properties	base GI4X-basis:Laenderkennzeichen_Stp												
used by	elements Adresse Ctp/LKZ Adressat Oder Adresse Ctp/Adresse/LKZ Arzt Ctp/Adresse/LKZ Kasse Ctp/Adresse/LKZ Leistungserbringer Ctp/Adresse/LKZ MD Ctp/Adresse/LKZ Versicherter Ctp/Adresse/LKZ												
facets	<table border="1"> <thead> <tr> <th>Kind</th> <th>Value</th> <th>Annotation</th> </tr> </thead> <tbody> <tr> <td>minLength</td> <td>1</td> <td></td> </tr> <tr> <td>maxLength</td> <td>3</td> <td></td> </tr> <tr> <td>pattern</td> <td>[A-Z]+</td> <td></td> </tr> </tbody> </table>	Kind	Value	Annotation	minLength	1		maxLength	3		pattern	[A-Z]+	
Kind	Value	Annotation											
minLength	1												
maxLength	3												
pattern	[A-Z]+												
annotation	documentation Länderkennzeichen nach Anlage 8 DEÜV. Es muss mindestens ein Zeichen enthalten sein.												
source	<pre><xs:simpleType name="LKZ_Stp"> <xs:annotation> <xs:documentation>Länderkennzeichen nach Anlage 8 DEÜV. Es muss mindestens ein Zeichen enthalten sein.</xs:documentation> </xs:annotation> <xs:restriction base="GI4X-basis:Laenderkennzeichen_Stp"/> </xs:simpleType></pre>												

simpleType Lokalisation_Stp

namespace	MD:/xml-schema/MD-basis/3.5												
type	restriction of xs:string												
properties	base xs:string												
used by	attributes Beauftragung/Auftrag/Infos/Diagnosen/Diagnose/@lokalisation Beauftragung/Auftrag/Infos/Prozeduren/Prozedur/@lokalisation Begutachtung/Stellungnahme/Pruefung/Diagnosen/Diagnose/KH/@lokalisation Begutachtung/Stellungnahme/Pruefung/Diagnosen/Diagnose/MD/@lokalisation Begutachtung/Stellungnahme/Pruefung/Prozeduren/Prozedur/KH/@lokalisation Begutachtung/Stellungnahme/Pruefung/Prozeduren/Prozedur/MD/@lokalisation												
facets	<table border="1"> <thead> <tr> <th>Kind</th> <th>Value</th> <th>Annotation</th> </tr> </thead> <tbody> <tr> <td>enumeration</td> <td>B</td> <td></td> </tr> <tr> <td>enumeration</td> <td>L</td> <td></td> </tr> <tr> <td>enumeration</td> <td>R</td> <td></td> </tr> </tbody> </table>	Kind	Value	Annotation	enumeration	B		enumeration	L		enumeration	R	
Kind	Value	Annotation											
enumeration	B												
enumeration	L												
enumeration	R												
annotation	documentation TA301 Schlüssel 16: Lokalisation B = Beide R = Rechts L = Links												
source	<pre><xs:simpleType name="Lokalisation_Stp"> <xs:annotation> <xs:documentation>TA301 Schlüssel 16: Lokalisation B = Beide</xs:documentation> </xs:annotation> <xs:restriction base="xs:string" enumeration="B L R"/> </xs:simpleType></pre>												

	R = Rechts L = Links </xs:documentation> </xs:annotation> <xs:restriction base="xs:string"> <xs:enumeration value="B"/> <xs:enumeration value="L"/> <xs:enumeration value="R"/> </xs:restriction> </xs:simpleType>
--	---

simpleType Mobiltelefon_Stp

namespace	MD/xml-schema/MD-basis/3.5												
type	restriction of GI4X-basis:Rufnummer_Stp												
properties	base GI4X-basis:Rufnummer_Stp												
used by	elements Kontaktdaten_Ctp/Mobiltelefon Adressat Oder Adresse_Ctp/Kontakt/Mobiltelefon Arzt_Ctp/Kontakt/Mobiltelefon Kasse_Ctp/Kontakt/Mobiltelefon Leistungserbringer_Ctp/Kontakt/Mobiltelefon MD_Ctp/Kontakt/Mobiltelefon Versicherter_Ctp/Kontakt/Mobiltelefon												
facets	<table border="1"> <thead> <tr> <th>Kind</th> <th>Value</th> <th>Annotation</th> </tr> </thead> <tbody> <tr> <td>minLength</td> <td>1</td> <td></td> </tr> <tr> <td>maxLength</td> <td>20</td> <td></td> </tr> <tr> <td>pattern</td> <td>\S*.*[\p{L}\p{N}].*</td> <td></td> </tr> </tbody> </table>	Kind	Value	Annotation	minLength	1		maxLength	20		pattern	\S*.*[\p{L}\p{N}].*	
Kind	Value	Annotation											
minLength	1												
maxLength	20												
pattern	\S*.*[\p{L}\p{N}].*												
annotation	documentation Mobiltelefonnummer. Es muss mindestens ein Zeichen enthalten sein.												
source	<xs:simpleType name="Mobiltelefon_Stp"> <xs:annotation> <xs:documentation>Mobiltelefonnummer. Es muss mindestens ein Zeichen enthalten sein.</xs:documentation> </xs:annotation> <xs:restriction base="GI4X-basis:Rufnummer_Stp"> <xs:pattern value="\S*.*[\p{L}\p{N}].*" /> </xs:restriction> </xs:simpleType>												

simpleType Name_Stp

namespace	MD/xml-schema/MD-basis/3.5						
type	restriction of GI4X-basis:Nachname_Stp						
properties	base GI4X-basis:Nachname_Stp						
used by	elements Beratungsstelle_MD_Ctp/Beratungsstelle_Name_SFB_Standort_Ctp/Name_Person_Ctp/Name Adressat Oder Adresse_Ctp/Person/Name_Arzt_Ctp/Person/Name_Kasse_Ctp/Name Leistungserbringer_Ctp/Name_Versicherter_Ctp/Person/Name_Leistungserbringer_Ctp/Name_Geschaef Vorherige_SFB_Ctp/Name_MD_Nebenstelle_Kasse_Ctp/Nebenstelle_Name_Person_Ctp/Vorname Adressat Oder Adresse_Ctp/Person/Vorname_Arzt_Ctp/Person/Vorname Versicherter_Ctp/Person/Vorname						
facets	<table border="1"> <thead> <tr> <th>Kind</th> <th>Value</th> <th>Annotation</th> </tr> </thead> <tbody> <tr> <td>minLength</td> <td>1</td> <td></td> </tr> </tbody> </table>	Kind	Value	Annotation	minLength	1	
Kind	Value	Annotation					
minLength	1						

	maxLength 45 pattern \S*.[\p{L}].*
annotation	documentation Dieser Datentyp modelliert den Vor- und Nachnamen einer Person und der Name einer Institution. Der Name muss mindestens 1 Buchstaben enthalten.
source	<pre> <xs:simpleType name="Name_Stp"> <xs:annotation> <xs:documentation>Dieser Datentyp modelliert den Vor- und Nachnamen einer Person und der Name einer Institution. Der Name muss mindestens 1 Buchstaben enthalten.</xs:documentation> </xs:annotation> <xs:restriction base="GI4X-basis:Nachname_Stp"> <xs:maxLength value="45"/> <xs:pattern value="\S*.[\p{L}].*" /> </xs:restriction> </xs:simpleType> </pre>

simpleType Namenszusatz_Stp

namespace	MD:/xml-schema/MD-basis/3.5												
type	restriction of GI4X-basis:Namenszusatz_Stp												
properties	base GI4X-basis:Namenszusatz_Stp												
used by	elements Person_Ctp/Namenszusatz_Adressat_Oder_Adresse_Ctp/Person/Namenszusatz Arzt_Ctp/Person/Namenszusatz_Versicherter_Ctp/Person/Namenszusatz												
facets	<table border="1"> <thead> <tr> <th>Kind</th> <th>Value</th> <th>Annotation</th> </tr> </thead> <tbody> <tr> <td>minLength</td> <td>1</td> <td></td> </tr> <tr> <td>maxLength</td> <td>20</td> <td></td> </tr> <tr> <td>pattern</td> <td>\S*.[\p{L}].*</td> <td></td> </tr> </tbody> </table>	Kind	Value	Annotation	minLength	1		maxLength	20		pattern	\S*.[\p{L}].*	
Kind	Value	Annotation											
minLength	1												
maxLength	20												
pattern	\S*.[\p{L}].*												
annotation	documentation Dieser Typ modelliert den Namenszusatz einer Person. Die erlaubten Werte sind durch Anlage 7 DEÜV vorgegeben. Der Name muss mindestens 1 Buchstaben enthalten.												
source	<pre> <xs:simpleType name="Namenszusatz_Stp"> <xs:annotation> <xs:documentation>Dieser Typ modelliert den Namenszusatz einer Person. Die erlaubten Werte sind durch Anlage 7 DEÜV vorgegeben. Der Name muss mindestens 1 Buchstaben enthalten.</xs:documentation> </xs:annotation> <xs:restriction base="GI4X-basis:Namenszusatz_Stp"> <xs:pattern value="\S*.[\p{L}].*" /> </xs:restriction> </xs:simpleType> </pre>												

simpleType Nebenstellenummer_Stp

namespace	MD:/xml-schema/MD-basis/3.5
type	restriction of Char10_Stp
properties	base Char10_Stp
used by	elements Beratungsstelle_MD_Ctp/Beratungsstelle_Nummer Nebenstelle_Kasse_Ctp/Nebenstelle_Nummer

facets	<table border="1"> <thead> <tr> <th>Kind</th> <th>Value</th> <th>Annotation</th> </tr> </thead> <tbody> <tr> <td>minLength</td> <td>1</td> <td></td> </tr> <tr> <td>maxLength</td> <td>5</td> <td></td> </tr> <tr> <td>pattern</td> <td>\S+ [&#x0020;-&#x00FF;]*</td> <td></td> </tr> </tbody> </table>	Kind	Value	Annotation	minLength	1		maxLength	5		pattern	\S+ [-ÿ]*	
Kind	Value	Annotation											
minLength	1												
maxLength	5												
pattern	\S+ [-ÿ]*												
annotation	documentation Identifiziert Kasse/Nebenstelle, max. 5 Ziffern												
source	<pre><xs:simpleType name="Nebenstellennummer_Stp"> <xs:annotation> <xs:documentation>Identifiziert Kasse/Nebenstelle, max. 5 Ziffern</xs:documentation> </xs:annotation> <xs:restriction base="Char10_Stp"> <xs:minLength value="1"/> <xs:maxLength value="5"/> </xs:restriction> </xs:simpleType></pre>												

simpleType Ort_Stp

namespace	MD:/xml-schema/MD-basis/3.5												
type	restriction of G14X-basis:ISO88591_Stp												
properties	base G14X-basis:ISO88591_Stp												
used by	elements SFB_Standort_Ctp/Ort_Vorherige_SFB_Ctp/Ort_Adresse_Ctp/Ort_Adressat_Oder_Adresse_Ctp/Adresse/Ort_Arzt_Ctp/Adresse/Ort_Kasse_Ctp/Adresse/Ort_Leistungserbringer_Ctp/Adresse/Ort_MD_Ctp/Adresse/Ort_Versicherter_Ctp/Adresse/Ort_Adresse_Ctp/Ortsteil_Adressat_Oder_Adresse_Ctp/Adresse/Ortsteil_Arzt_Ctp/Adresse/Ortsteil_Kasse_Ctp/Adresse/Ortsteil_Leistungserbringer_Ctp/Adresse/Ortsteil_MD_Ctp/Adresse/Ortsteil_Versicherter_Ctp/Adresse/Ortsteil												
facets	<table border="1"> <thead> <tr> <th>Kind</th> <th>Value</th> <th>Annotation</th> </tr> </thead> <tbody> <tr> <td>minLength</td> <td>1</td> <td></td> </tr> <tr> <td>maxLength</td> <td>40</td> <td></td> </tr> <tr> <td>pattern</td> <td>\S*.*[\p{L}].*</td> <td></td> </tr> </tbody> </table>	Kind	Value	Annotation	minLength	1		maxLength	40		pattern	\S*.*[\p{L}].*	
Kind	Value	Annotation											
minLength	1												
maxLength	40												
pattern	\S*.*[\p{L}].*												
annotation	documentation Namen eines Ortes oder Ortsteiles (Gemeinde, Ortschaft oder Stadt). Es muss mindestens ein Buchstabe enthalten sein.												
source	<pre><xs:simpleType name="Ort_Stp"> <xs:annotation> <xs:documentation>Namen eines Ortes oder Ortsteiles (Gemeinde, Ortschaft oder Stadt). Es muss mindestens ein Buchstabe enthalten sein.</xs:documentation> </xs:annotation> <xs:restriction base="G14X-basis:ISO88591_Stp"> <xs:maxLength value="40"/> <xs:pattern value="\S*.*[\p{L}].*" /> </xs:restriction> </xs:simpleType></pre>												

simpleType PLZ_Stp

namespace	MD:/xml-schema/MD-basis/3.5
type	restriction of G14X-basis:Postleitzahl_Stp

properties	base GI4X-basis:Postleitzahl_Stp												
used by	elements SFB_Standort_Ctp/PLZ_Adresse_Ctp/PLZ_Adressat_Oder_Adresse_Ctp/Adresse/PLZ Arzt_Ctp/Adresse/PLZ_Kasse_Ctp/Adresse/PLZ_Leistungserbringer_Ctp/Adresse/PLZ MD_Ctp/Adresse/PLZ_Versicherter_Ctp/Adresse/PLZ												
facets	<table border="1"> <thead> <tr> <th>Kind</th> <th>Value</th> <th>Annotation</th> </tr> </thead> <tbody> <tr> <td>minLength</td> <td>1</td> <td></td> </tr> <tr> <td>maxLength</td> <td>10</td> <td></td> </tr> <tr> <td>pattern</td> <td>\S*.[\p{L}\p{N}+].*</td> <td></td> </tr> </tbody> </table>	Kind	Value	Annotation	minLength	1		maxLength	10		pattern	\S*.[\p{L}\p{N}+].*	
Kind	Value	Annotation											
minLength	1												
maxLength	10												
pattern	\S*.[\p{L}\p{N}+].*												
annotation	documentation Postleitzahl, max. 10 Zeichen												
source	<pre><xs:simpleType name="PLZ_Stp"> <xs:annotation> <xs:documentation>Postleitzahl, max. 10 Zeichen</xs:documentation> </xs:annotation> <xs:restriction base="GI4X-basis:Postleitzahl_Stp"> <xs:pattern value="\S*.[\p{L}\p{N}+].*" /> </xs:restriction> </xs:simpleType></pre>												

simpleType Posnr_Stp

namespace	MD:xml-schema/MD-basis/3.5									
type	restriction of xs:string									
properties	base xs:string									
facets	<table border="1"> <thead> <tr> <th>Kind</th> <th>Value</th> <th>Annotation</th> </tr> </thead> <tbody> <tr> <td>maxLength</td> <td>10</td> <td></td> </tr> <tr> <td>pattern</td> <td>[0-9]*</td> <td></td> </tr> </tbody> </table>	Kind	Value	Annotation	maxLength	10		pattern	[0-9]*	
Kind	Value	Annotation								
maxLength	10									
pattern	[0-9]*									
annotation	documentation maximal zehnstellig numerisch, mit führenden Nullen									
source	<pre><xs:simpleType name="Posnr_Stp"> <xs:annotation> <xs:documentation>maximal zehnstellig numerisch, mit führenden Nullen</xs:documentation> </xs:annotation> <xs:restriction base="xs:string"> <xs:maxLength value="10" /> <xs:pattern value="[0-9]*" /> </xs:restriction> </xs:simpleType></pre>									

simpleType Postfach_Stp

namespace	MD:xml-schema/MD-basis/3.5
type	restriction of Char50_Stp
properties	base Char50_Stp
used by	elements Adresse_Ctp/Postfach_Adressat_Oder_Adresse_Ctp/Adresse/Postfach Arzt_Ctp/Adresse/Postfach_Kasse_Ctp/Adresse/Postfach_Leistungserbringer_Ctp/Adresse/Postfach MD_Ctp/Adresse/Postfach_Versicherter_Ctp/Adresse/Postfach

facets	Kind	Value	Annotation
	minLength	1	
	maxLength	45	
	pattern	\S+ [-ÿ]*	
annotation	documentation	Postfach. Es muss mindestens ein Zeichen enthalten sein.	
source	<pre><xs:simpleType name="Postfach_Stp"> <xs:annotation> <xs:documentation>Postfach. Es muss mindestens ein Zeichen enthalten sein.</xs:documentation> </xs:annotation> <xs:restriction base="Char50_Stp"> <xs:minLength value="1"/> <xs:maxLength value="45"/> </xs:restriction> </xs:simpleType></pre>		

simpleType Sachbearbeiter_Orga_Stp

namespace	MD:/xml-schema/MD-basis/3.5		
type	restriction of Char30_Stp		
properties	base	Char30_Stp	
used by	elements	MD_Ctp/Ansprechpartner Kasse_Ctp/Sachbearbeiter	
facets	Kind	Value	Annotation
	minLength	2	
	maxLength	30	
	pattern	\S+ [-ÿ]*	
annotation	documentation	Name des Sachbearbeiter/ORG-Einheit	
source	<pre><xs:simpleType name="Sachbearbeiter_Orga_Stp"> <xs:annotation> <xs:documentation>Name des Sachbearbeiter/ORG-Einheit</xs:documentation> </xs:annotation> <xs:restriction base="Char30_Stp"> <xs:minLength value="2"/> </xs:restriction> </xs:simpleType></pre>		

simpleType Strasse_Hausnummer_Stp

namespace	MD:/xml-schema/MD-basis/3.5		
type	restriction of GI4X-basis:ISO88591_Stp		
properties	base	GI4X-basis:ISO88591_Stp	
used by	elements	SFB_Standort_Ctp/Strasse_Hausnummer Adresse_Ctp/Strasse_Hausnummer Adressat_Oder_Adresse_Ctp/Adresse/Strasse_Hausnummer Arzt_Ctp/Adresse/Strasse_Hausnummer Kasse_Ctp/Adresse/Strasse_Hausnummer Leistungserbringer_Ctp/Adresse/Strasse_Hausnummer MD_Ctp/Adresse/Strasse_Hausnummer Versicherter_Ctp/Adresse/Strasse_Hausnummer	

facets	<table border="1"> <thead> <tr> <th>Kind</th> <th>Value</th> <th>Annotation</th> </tr> </thead> <tbody> <tr> <td>minLength</td> <td>1</td> <td></td> </tr> <tr> <td>maxLength</td> <td>56</td> <td></td> </tr> <tr> <td>pattern</td> <td>\S*.[\p{L}].*</td> <td></td> </tr> </tbody> </table>	Kind	Value	Annotation	minLength	1		maxLength	56		pattern	\S*.[\p{L}].*	
Kind	Value	Annotation											
minLength	1												
maxLength	56												
pattern	\S*.[\p{L}].*												
annotation	documentation Straße und Hausnummer. Es muss mindestens ein Buchstabe enthalten sein.												
source	<pre><xs:simpleType name="Strasse_Hausnummer_Stp"> <xs:annotation> <xs:documentation>Straße und Hausnummer. Es muss mindestens ein Buchstabe enthalten sein.</xs:documentation> </xs:annotation> <xs:restriction base="GI4X-basis:IS088591_Stp"> <xs:maxLength value="56"/> <xs:pattern value="\S*.[\p{L}].*" /> </xs:restriction> </xs:simpleType></pre>												

simpleType TA_Version_Stp

namespace	MD:/xml-schema/MD-basis/3.5						
type	restriction of xs:string						
properties	base xs:string						
used by	simpleType Schluessel_V_Stp						
facets	<table border="1"> <thead> <tr> <th>Kind</th> <th>Value</th> <th>Annotation</th> </tr> </thead> <tbody> <tr> <td>pattern</td> <td>[1-9][0-9]?\.?[1-9]?[0-9]</td> <td></td> </tr> </tbody> </table>	Kind	Value	Annotation	pattern	[1-9][0-9]?\.?[1-9]?[0-9]	
Kind	Value	Annotation					
pattern	[1-9][0-9]?\.?[1-9]?[0-9]						
annotation	documentation TA Versionsnummer						
source	<pre><xs:simpleType name="TA_Version_Stp"> <xs:annotation> <xs:documentation>TA Versionsnummer</xs:documentation> </xs:annotation> <xs:restriction base="xs:string"> <xs:pattern value="[1-9][0-9]?\.?[1-9]?[0-9]" /> </xs:restriction> </xs:simpleType></pre>						

simpleType Telefax_Stp

namespace	MD:/xml-schema/MD-basis/3.5									
type	restriction of GI4X-basis:Rufnummer_Stp									
properties	base GI4X-basis:Rufnummer_Stp									
used by	elements Kontaktdaten_Ctp/Telefax Adressat_Oder_Adresse_Ctp/Kontakt/Telefax Arzt_Ctp/Kontakt/Telefax Kasse_Ctp/Kontakt/Telefax Leistungserbringer_Ctp/Kontakt/Telefax MD_Ctp/Kontakt/Telefax Versicherter_Ctp/Kontakt/Telefax									
facets	<table border="1"> <thead> <tr> <th>Kind</th> <th>Value</th> <th>Annotation</th> </tr> </thead> <tbody> <tr> <td>minLength</td> <td>1</td> <td></td> </tr> <tr> <td>maxLength</td> <td>20</td> <td></td> </tr> </tbody> </table>	Kind	Value	Annotation	minLength	1		maxLength	20	
Kind	Value	Annotation								
minLength	1									
maxLength	20									

	pattern \S*.[\p{L}\p{N}].*
annotation	documentation Telefaxnummer. Es muss mindestens ein Zeichen enthalten sein.
source	<pre><xs:simpleType name="Telefax_Stp"> <xs:annotation> <xs:documentation>Telefaxnummer. Es muss mindestens ein Zeichen enthalten sein.</xs:documentation> </xs:annotation> <xs:restriction base="GI4X-basis:Rufnummer_Stp"> <xs:pattern value="\S*.[\p{L}\p{N}].*" /> </xs:restriction> </xs:simpleType></pre>

simpleType Telefon_Stp

namespace	MD:/xml-schema/MD-basis/3.5												
type	restriction of GI4X-basis:Rufnummer_Stp												
properties	base GI4X-basis:Rufnummer_Stp												
used by	elements Kontaktdaten_Ctp/Telefon Adressat Oder Adresse_Ctp/Kontakt/Telefon Arzt_Ctp/Kontakt/Telefon Kasse_Ctp/Kontakt/Telefon Leistungserbringer_Ctp/Kontakt/Telefon MD_Ctp/Kontakt/Telefon Versicherter_Ctp/Kontakt/Telefon												
facets	<table border="1"> <thead> <tr> <th>Kind</th> <th>Value</th> <th>Annotation</th> </tr> </thead> <tbody> <tr> <td>minLength</td> <td>1</td> <td></td> </tr> <tr> <td>maxLength</td> <td>20</td> <td></td> </tr> <tr> <td>pattern</td> <td>\S*.[\p{L}\p{N}].*</td> <td></td> </tr> </tbody> </table>	Kind	Value	Annotation	minLength	1		maxLength	20		pattern	\S*.[\p{L}\p{N}].*	
Kind	Value	Annotation											
minLength	1												
maxLength	20												
pattern	\S*.[\p{L}\p{N}].*												
annotation	documentation Telefonnummer. Es muss mindestens ein Zeichen enthalten sein.												
source	<pre><xs:simpleType name="Telefon_Stp"> <xs:annotation> <xs:documentation>Telefonnummer. Es muss mindestens ein Zeichen enthalten sein.</xs:documentation> </xs:annotation> <xs:restriction base="GI4X-basis:Rufnummer_Stp"> <xs:pattern value="\S*.[\p{L}\p{N}].*" /> </xs:restriction> </xs:simpleType></pre>												

simpleType Titel_Stp

namespace	MD:/xml-schema/MD-basis/3.5												
type	restriction of GI4X-basis:Namenstitel_Stp												
properties	base GI4X-basis:Namenstitel_Stp												
used by	elements Person_Ctp/Titel Adressat Oder Adresse_Ctp/Person/Titel Arzt_Ctp/Person/Titel Versicherter_Ctp/Person/Titel												
facets	<table border="1"> <thead> <tr> <th>Kind</th> <th>Value</th> <th>Annotation</th> </tr> </thead> <tbody> <tr> <td>minLength</td> <td>1</td> <td></td> </tr> <tr> <td>maxLength</td> <td>20</td> <td></td> </tr> <tr> <td>pattern</td> <td>\S*.[\p{L}].*</td> <td></td> </tr> </tbody> </table>	Kind	Value	Annotation	minLength	1		maxLength	20		pattern	\S*.[\p{L}].*	
Kind	Value	Annotation											
minLength	1												
maxLength	20												
pattern	\S*.[\p{L}].*												

annotation	documentation Dieser Datentyp modelliert den Titel einer Person. Der Name muss mindestens 1 Buchstaben enthalten.
source	<pre><xs:simpleType name="Titel_Stp"> <xs:annotation> <xs:documentation>Dieser Datentyp modelliert den Titel einer Person. Der Name muss mindestens 1 Buchstaben enthalten.</xs:documentation> </xs:annotation> <xs:restriction base="GI4X-basis:Namenstitel_Stp"> <xs:pattern value="\S*.*[\p{L}].*" /> </xs:restriction> </xs:simpleType></pre>

simpleType Verfahrensart_Stp

namespace	MD:/xml-schema/MD-basis/3.5																																																
type	restriction of xs:string																																																
properties	base xs:string																																																
facets	<table border="1"> <thead> <tr> <th>Kind</th> <th>Value</th> <th>Annotation</th> </tr> </thead> <tbody> <tr><td>enumeration</td><td>61</td><td></td></tr> <tr><td>enumeration</td><td>62</td><td></td></tr> <tr><td>enumeration</td><td>63</td><td></td></tr> <tr><td>enumeration</td><td>64</td><td></td></tr> <tr><td>enumeration</td><td>81</td><td></td></tr> <tr><td>enumeration</td><td>82</td><td></td></tr> <tr><td>enumeration</td><td>85</td><td></td></tr> <tr><td>enumeration</td><td>86</td><td></td></tr> <tr><td>enumeration</td><td>87</td><td></td></tr> <tr><td>enumeration</td><td>91</td><td></td></tr> <tr><td>enumeration</td><td>92</td><td></td></tr> <tr><td>enumeration</td><td>93</td><td></td></tr> <tr><td>enumeration</td><td>94</td><td></td></tr> <tr><td>enumeration</td><td>95</td><td></td></tr> <tr><td>enumeration</td><td>99</td><td></td></tr> </tbody> </table>	Kind	Value	Annotation	enumeration	61		enumeration	62		enumeration	63		enumeration	64		enumeration	81		enumeration	82		enumeration	85		enumeration	86		enumeration	87		enumeration	91		enumeration	92		enumeration	93		enumeration	94		enumeration	95		enumeration	99	
Kind	Value	Annotation																																															
enumeration	61																																																
enumeration	62																																																
enumeration	63																																																
enumeration	64																																																
enumeration	81																																																
enumeration	82																																																
enumeration	85																																																
enumeration	86																																																
enumeration	87																																																
enumeration	91																																																
enumeration	92																																																
enumeration	93																																																
enumeration	94																																																
enumeration	95																																																
enumeration	99																																																
annotation	documentation Verfahrensart / Anspruchgrundlage 61 = allgemeines Heilverfahren (ohne AHB) - gilt nur für LAKn 62 = Anschlussheilverfahren - gilt nur für LAKn 63 = Nach- und Festigungskur - gilt nur für LAKn 64 = Kinderheilverfahren - gilt nur für LAKn 81 = medizinische Vorsorgemaßnahme nach § 23 SGB V im Rahmen des DMP 82 = medizinische Rehabilitation nach § 40 SGB V im Rahmen des DMP 85 = medizinische Vorsorgemaßnahme nach § 23 SGB V im Rahmen der integrierten Versorgung 86 = medizinische Rehabilitation nach § 40 SGB V im Rahmen der integrierten Versorgung 87 = Anschluss-Rehabilitation nach § 40 SGB V i.R der IV 91 = medizinische Vorsorgeleistung nach § 23 SGB V 92 = medizinische Rehabilitation nach § 40 SGB V 93 = Anschlussrehabilitation / Anschlussheilbehandlung nach § 40 SGB V 94 = medizinische Vorsorge für Mütter und Väter nach § 24 SGB V 95 = medizinische Rehabilitation für Mütter und Väter nach § 41 SGB V 99 = Sonstige																																																

source	<pre> <xs:simpleType name="Verfahrensart_Stp"> <xs:annotation> <xs:documentation>Verfahrensart / Anspruchgrundlage 61 = allgemeines Heilverfahren (ohne AHB) - gilt nur für LAKn 62 = Anschlussheilverfahren - gilt nur für LAKn 63 = Nach- und Festigungskur - gilt nur für LAKn 64 = Kinderheilverfahren - gilt nur für LAKn 81 = medizinische Vorsorgemaßnahme nach § 23 SGB V im Rahmen des DMP 82 = medizinische Rehabilitation nach § 40 SGB V im Rahmen des DMP 85 = medizinische Vorsorgemaßnahme nach § 23 SGB V im Rahmen der integrierten Versorgung 86 = medizinische Rehabilitation nach § 40 SGB V im Rahmen der integrierten Versorgung 87 = Anschluss-Rehabilitation nach § 40 SGB V i. R der IV 91 = medizinische Vorsorgeleistung nach § 23 SGB V 92 = medizinische Rehabilitation nach § 40 SGB V 93 = Anschlussrehabilitation / Anschlussheilbehandlung nach § 40 SGB V 94 = medizinische Vorsorge für Mütter und Väter nach § 24 SGB V 95 = medizinische Rehabilitation für Mütter und Väter nach § 41 SGB V 99 = Sonstige </xs:documentation> </xs:annotation> <xs:restriction base="xs:string"> <xs:enumeration value="61"/> <xs:enumeration value="62"/> <xs:enumeration value="63"/> <xs:enumeration value="64"/> <xs:enumeration value="81"/> <xs:enumeration value="82"/> <xs:enumeration value="85"/> <xs:enumeration value="86"/> <xs:enumeration value="87"/> <xs:enumeration value="91"/> <xs:enumeration value="92"/> <xs:enumeration value="93"/> <xs:enumeration value="94"/> <xs:enumeration value="95"/> <xs:enumeration value="99"/> </xs:restriction> </xs:simpleType> </pre>
--------	---

simpleType Vorsatzwort_Stp

namespace	MD:/xml-schema/MD-basis/3.5									
type	restriction of G14X-basis:Namensvorsatz_Stp									
properties	base G14X-basis:Namensvorsatz_Stp									
used by	elements Person_Ctp/Vorsatzwort Adressat Oder Adresse_Ctp/Person/Vorsatzwort Arzt_Ctp/Person/Vorsatzwort Versicherter_Ctp/Person/Vorsatzwort									
facets	<table border="1"> <thead> <tr> <th>Kind</th> <th>Value</th> <th>Annotation</th> </tr> </thead> <tbody> <tr> <td>minLength</td> <td>1</td> <td></td> </tr> <tr> <td>maxLength</td> <td>20</td> <td></td> </tr> </tbody> </table>	Kind	Value	Annotation	minLength	1		maxLength	20	
Kind	Value	Annotation								
minLength	1									
maxLength	20									

	pattern \S*.[\p{L}].*
annotation	documentation Dieser Datentyp modelliert den Namensvorsatz einer Person. Die erlaubten Werte sind durch Anlage 6 DEÜV vorgegeben. Der Name muss mindestens 1 Buchstaben enthalten.
source	<pre><xs:simpleType name="Vorsatzwort_Stp"> <xs:annotation> <xs:documentation>Dieser Datentyp modelliert den Namensvorsatz einer Person. Die erlaubten Werte sind durch Anlage 6 DEÜV vorgegeben. Der Name muss mindestens 1 Buchstaben enthalten.</xs:documentation> </xs:annotation> <xs:restriction base="Gl4X-basis: Namensvorsatz_Stp"> <xs:pattern value="\S*.[\p{L}].*" /> </xs:restriction> </xs:simpleType></pre>

simpleType Zahnarzt_NR_Stp

namespace	MD:/xml-schema/MD-basis/3.5												
type	restriction of Char20_Stp												
properties	base Char20_Stp												
used by	element Identifikationsmerkmal_Ctp/Zahnarztnummer												
facets	<table border="1"> <thead> <tr> <th>Kind</th> <th>Value</th> <th>Annotation</th> </tr> </thead> <tbody> <tr> <td>minLength</td> <td>1</td> <td></td> </tr> <tr> <td>maxLength</td> <td>17</td> <td></td> </tr> <tr> <td>pattern</td> <td>\S+ [&#x0020;-&#x00FF;]*</td> <td></td> </tr> </tbody> </table>	Kind	Value	Annotation	minLength	1		maxLength	17		pattern	\S+ [-ÿ]*	
Kind	Value	Annotation											
minLength	1												
maxLength	17												
pattern	\S+ [-ÿ]*												
annotation	documentation Zahnarztnummer (kodiert).												
source	<pre><xs:simpleType name="Zahnarzt_NR_Stp"> <xs:annotation> <xs:documentation>Zahnarztnummer (kodiert).</xs:documentation> </xs:annotation> <xs:restriction base="Char20_Stp"> <xs:minLength value="1" /> <xs:maxLength value="17" /> </xs:restriction> </xs:simpleType></pre>												

simpleType Zeitbedarf_Stp

namespace	MD:/xml-schema/MD-basis/3.5									
type	restriction of xs:string									
properties	base xs:string									
facets	<table border="1"> <thead> <tr> <th>Kind</th> <th>Value</th> <th>Annotation</th> </tr> </thead> <tbody> <tr> <td>maxLength</td> <td>4</td> <td></td> </tr> <tr> <td>pattern</td> <td>(([0-9]) ([1-9][0-9]) ([1-9][0-9][0-9]) ([10-3][0-9][0-9]) ([14][0-1][0-9]) (1420))</td> <td></td> </tr> </tbody> </table>	Kind	Value	Annotation	maxLength	4		pattern	(([0-9]) ([1-9][0-9]) ([1-9][0-9][0-9]) ([10-3][0-9][0-9]) ([14][0-1][0-9]) (1420))	
Kind	Value	Annotation								
maxLength	4									
pattern	(([0-9]) ([1-9][0-9]) ([1-9][0-9][0-9]) ([10-3][0-9][0-9]) ([14][0-1][0-9]) (1420))									
annotation	documentation Zeitbedarf in Minuten pro Tag (maximal 1420 min)									

n	
source	<pre> <xs:simpleType name="Zeitbedarf_Stp"> <xs:annotation> <xs:documentation>Zeitbedarf in Minuten pro Tag (maximal 1420 min)</xs:documentation> </xs:annotation> <xs:restriction base="xs:string"> <xs:maxLength value="4"/> <xs:pattern value="([0-9]) ([1-9][0-9]) ([1-9][0-9][0-9]) (1[0-3][0-9][0-9]) (14[0-1][0-9]) (1420)"/> </xs:restriction> </xs:simpleType> </pre>

simpleType Zeitpunkt_kurz_Stp

namespace	MD:/xml-schema/MD-basis/3.5									
type	restriction of xs:string									
properties	base xs:string									
facets	<table border="1"> <thead> <tr> <th>Kind</th> <th>Value</th> <th>Annotation</th> </tr> </thead> <tbody> <tr> <td>length</td> <td>5</td> <td></td> </tr> <tr> <td>pattern</td> <td>((0[0-9]) (1[0-9]) (2[0-3])):[0-5][0-9]</td> <td></td> </tr> </tbody> </table>	Kind	Value	Annotation	length	5		pattern	((0[0-9]) (1[0-9]) (2[0-3])):[0-5][0-9]	
Kind	Value	Annotation								
length	5									
pattern	((0[0-9]) (1[0-9]) (2[0-3])):[0-5][0-9]									
annotation	documentation Zeitpunkt im Format HH:MM									
source	<pre> <xs:simpleType name="Zeitpunkt_kurz_Stp"> <xs:annotation> <xs:documentation>Zeitpunkt im Format HH:MM</xs:documentation> </xs:annotation> <xs:restriction base="xs:string"> <xs:length value="5"/> <xs:pattern value="((0[0-9]) (1[0-9]) (2[0-3])):[0-5][0-9]"/> </xs:restriction> </xs:simpleType> </pre>									

simpleType Zeitpunkt_Stp

namespace	MD:/xml-schema/MD-basis/3.5									
type	restriction of xs:string									
properties	base xs:string									
used by	attribute y kz Grp/@erstellungzeit									
facets	<table border="1"> <thead> <tr> <th>Kind</th> <th>Value</th> <th>Annotation</th> </tr> </thead> <tbody> <tr> <td>length</td> <td>8</td> <td></td> </tr> <tr> <td>pattern</td> <td>((0[0-9]) (1[0-9]) (2[0-3])):[0-5][0-9]:[0-5][0-9]</td> <td></td> </tr> </tbody> </table>	Kind	Value	Annotation	length	8		pattern	((0[0-9]) (1[0-9]) (2[0-3])):[0-5][0-9]:[0-5][0-9]	
Kind	Value	Annotation								
length	8									
pattern	((0[0-9]) (1[0-9]) (2[0-3])):[0-5][0-9]:[0-5][0-9]									
annotation	documentation Zeitpunkt im Format HH:MM:SS									
source	<pre> <xs:simpleType name="Zeitpunkt_Stp"> <xs:annotation> </pre>									

<pre> <xs:documentation>Zeitpunkt im Format HH:MM:SS</xs:documentation> </xs:annotation> <xs:restriction base="xs:string"> <xs:length value="8"/> <xs:pattern value="((0[0-9]) (1[0-9]) (2[0-3])):[0-5][0-9]:[0-5][0-9]"/> </xs:restriction> </xs:simpleType> </pre>
--

attributeGroup vkz_Grp

namespace	MD:/xml-schema/MD-basis/3.5					
used by	elements Beauftragung Begutachtung					
attributes	Name	Type	Use	Default	Fixed	Annotation
	ik_absender	IK_Stp	required			documentation VKZ01: Institutionskennzeichen des Absenders
	ik_empfaenger	IK_Stp	required			documentation VKZ02: Institutionskennzeichen des Empfängers
	erstellungdatum	Datum_Stp	required			documentation VKZ03: Erstellungsdatum der Datei, JJJJ-MM-TT
	erstellungzeit	Zeitpunkt_Stp	required			documentation VKZ04: Erstellungszeit der Datei, hh:mm:ss
	dateinummer	derived by: xs:positiveInteger	required			documentation VKZ05: Nummer der Datei
annotation	documentation VKZ Segment					
source	<pre> <xs:attributeGroup name="vkz_Grp"> <xs:annotation> <xs:documentation>VKZ Segment</xs:documentation> </xs:annotation> <xs:attribute name="ik_absender" type="IK_Stp" use="required"> <xs:annotation> <xs:documentation>VKZ01: Institutionskennzeichen des Absenders</xs:documentation> </xs:annotation> </xs:attribute> <xs:attribute name="ik_empfaenger" type="IK_Stp" use="required"> <xs:annotation> <xs:documentation>VKZ02: Institutionskennzeichen des Empfängers</xs:documentation> </xs:annotation> </xs:attribute> <xs:attribute name="erstellungdatum" type="Datum_Stp" use="required"> <xs:annotation> <xs:documentation>VKZ03: Erstellungsdatum der Datei , JJJJ-MM-TT</xs:documentation> </xs:annotation> </pre>					

	<pre> </xs:attribute> <xs:attribute name="erstellungzeit" type="Zeitpunkt_Stp" use="required"> <xs:annotation> <xs:documentation>VKZ04: Erstellungszeit der Datei , hh:mm:ss</xs:documentation> </xs:annotation> </xs:attribute> <xs:attribute name="dateinummer" use="required"> <xs:annotation> <xs:documentation>VKZ05: Nummer der Datei </xs:documentation> </xs:annotation> <xs:simpleType> <xs:restriction base="xs:positiveInteger"> <xs:maxInclusive value="2147483647"/> </xs:restriction> </xs:simpleType> </xs:attribute> </xs:attributeGroup> </pre>
--	--

attribute vkz_Grp/@ik_absender

type	IK_Stp												
properties	use required												
facets	<table border="1"> <thead> <tr> <th>Kind</th> <th>Value</th> <th>Annotation</th> </tr> </thead> <tbody> <tr> <td>minLength</td> <td>9</td> <td></td> </tr> <tr> <td>maxLength</td> <td>9</td> <td></td> </tr> <tr> <td>pattern</td> <td>[1-9][0-9]+</td> <td></td> </tr> </tbody> </table>	Kind	Value	Annotation	minLength	9		maxLength	9		pattern	[1-9][0-9]+	
Kind	Value	Annotation											
minLength	9												
maxLength	9												
pattern	[1-9][0-9]+												
annotation	documentation VKZ01: Institutionskennzeichen des Absenders												
source	<pre> <xs:attribute name="ik_absender" type="IK_Stp" use="required"> <xs:annotation> <xs:documentation>VKZ01: Institutionskennzeichen des Absenders</xs:documentation> </xs:annotation> </xs:attribute> </pre>												

attribute vkz_Grp/@ik_empfaenger

type	IK_Stp												
properties	use required												
facets	<table border="1"> <thead> <tr> <th>Kind</th> <th>Value</th> <th>Annotation</th> </tr> </thead> <tbody> <tr> <td>minLength</td> <td>9</td> <td></td> </tr> <tr> <td>maxLength</td> <td>9</td> <td></td> </tr> <tr> <td>pattern</td> <td>[1-9][0-9]+</td> <td></td> </tr> </tbody> </table>	Kind	Value	Annotation	minLength	9		maxLength	9		pattern	[1-9][0-9]+	
Kind	Value	Annotation											
minLength	9												
maxLength	9												
pattern	[1-9][0-9]+												
annotation	documentation VKZ02: Institutionskennzeichen des Empfängers												
source	<pre> <xs:attribute name="ik_empfaenger" type="IK_Stp" use="required"> <xs:annotation> <xs:documentation>VKZ02: Institutionskennzeichen des </pre>												

	Empfängers</xs: documentati on> </xs: annotati on> </xs: attri bute>
--	--

attribute vkz_Grp/@erstellungdatum

type	Datum_Stp									
properties	use required									
facets	<table border="1"> <thead> <tr> <th>Kind</th> <th>Value</th> <th>Annotation</th> </tr> </thead> <tbody> <tr> <td>minInclusive</td> <td>1850-01-01</td> <td></td> </tr> <tr> <td>maxInclusive</td> <td>2099-12-31</td> <td></td> </tr> </tbody> </table>	Kind	Value	Annotation	minInclusive	1850-01-01		maxInclusive	2099-12-31	
Kind	Value	Annotation								
minInclusive	1850-01-01									
maxInclusive	2099-12-31									
annotation	documentation VKZ03: Erstellungsdatum der Datei, JJJ-MM-TT									
source	<xs: attribute name="erstellungdatum" type="Datum_Stp" use="requi red"> <xs: annotati on> <xs: documentati on>VKZ03: Erstel lugsdatum der Datei , JJJJ-MM-TT</xs: documentati on> </xs: annotati on> </xs: attri bute>									

attribute vkz_Grp/@erstellungzeit

type	Zeitpunkt_Stp									
properties	use required									
facets	<table border="1"> <thead> <tr> <th>Kind</th> <th>Value</th> <th>Annotation</th> </tr> </thead> <tbody> <tr> <td>length</td> <td>8</td> <td></td> </tr> <tr> <td>pattern</td> <td>((0[0-9]) (1[0-9]) (2[0-3])):[0-5][0-9]:[0-5][0-9]</td> <td></td> </tr> </tbody> </table>	Kind	Value	Annotation	length	8		pattern	((0[0-9]) (1[0-9]) (2[0-3])):[0-5][0-9]:[0-5][0-9]	
Kind	Value	Annotation								
length	8									
pattern	((0[0-9]) (1[0-9]) (2[0-3])):[0-5][0-9]:[0-5][0-9]									
annotation	documentation VKZ04: Erstellungszeit der Datei, hh:mm:ss									
source	<xs: attribute name="erstellungzei t" type="Zei tpunkt_Stp" use="requi red"> <xs: annotati on> <xs: documentati on>VKZ04: Erstel lugszei t der Datei , hh: mm: ss</xs: documentati on> </xs: annotati on> </xs: attri bute>									

attribute vkz_Grp/@dateinummer

type	restriction of xs:positiveInteger						
properties	use required						
facets	<table border="1"> <thead> <tr> <th>Kind</th> <th>Value</th> <th>Annotation</th> </tr> </thead> <tbody> <tr> <td>maxInclusive</td> <td>2147483647</td> <td></td> </tr> </tbody> </table>	Kind	Value	Annotation	maxInclusive	2147483647	
Kind	Value	Annotation					
maxInclusive	2147483647						
annotation	documentation VKZ05: Nummer der Datei						
source	<xs: attribute name="datei nummer" use="requi red"> <xs: annotati on> <xs: documentati on>VKZ05: Nummer der Datei </xs: documentati on> </xs: annotati on>						

	<pre> <xs:simpleType> <xs:restriction base="xs:positiveInteger"> <xs:maxInclusive value="2147483647"/> </xs:restriction> </xs:simpleType> </xs:attribute> </pre>
--	--

complexType CT_Antworten

diagram	
namespace	http://www.aok-systems.de/xml-schema/EMDK0-basis-3.0.0
children	antwort
used by	element Begutachtung/Stellungnahme/Antworten
annotation	documentation Antwort auf die Fragestellung und die Begründung
source	<pre> <xs:complexType name="CT_Antworten"> <xs:annotation> <xs:documentation>Antwort auf die Fragestellung und die Begründung</xs:documentation> </xs:annotation> <xs:sequence minOccurs="0"> <xs:element name="antwort" minOccurs="0" maxOccurs="99"> <xs:annotation> <xs:documentation>GRK-Sätze</xs:documentation> </xs:annotation> <xs:complexType> <xs:attribute name="frage_ID" type="Frage_ID" use="required"> <xs:annotation> <xs:documentation>GRK01: Antwort zur Fragestellung</xs:documentation> </xs:annotation> </xs:attribute> <xs:attribute name="antwortzeichen" type="Antwortzeichen" use="required"> <xs:annotation> <xs:documentation>GRK02: Antwortzeichen auf gestellte Fragestellungen</xs:documentation> </xs:annotation> </xs:attribute> <xs:attribute name="begruendung" type="Frei text_1024" use="optional"> <xs:annotation> <xs:documentation>GRK03: Begründung der Antwort</xs:documentation> </xs:annotation> </xs:attribute> </xs:complexType> </xs:element> </xs:sequence> </xs:complexType> </pre>

element CT_Antworten/antwort

diagram																									
namespace	http://www.aok-systems.de/xml-schema/EMDK0-basis-3.0.0																								
properties	minOcc 0 maxOcc 99 content complex																								
attributes	<table border="1"> <thead> <tr> <th>Name</th> <th>Type</th> <th>Use</th> <th>Default</th> <th>Fixed</th> <th>Annotation</th> </tr> </thead> <tbody> <tr> <td>frage_ID</td> <td>Frage_ID</td> <td>required</td> <td></td> <td></td> <td>documentation GRK01: Antwort zur Fragestellung</td> </tr> <tr> <td>antwortzeichen</td> <td>Antwortzeichen</td> <td>required</td> <td></td> <td></td> <td>documentation GRK02: Antwortzeichen auf gestellte Fragestellungen</td> </tr> <tr> <td>begruendung</td> <td>Freitext_1024</td> <td>optional</td> <td></td> <td></td> <td>documentation GRK03: Begründung der Antwort</td> </tr> </tbody> </table>	Name	Type	Use	Default	Fixed	Annotation	frage_ID	Frage_ID	required			documentation GRK01: Antwort zur Fragestellung	antwortzeichen	Antwortzeichen	required			documentation GRK02: Antwortzeichen auf gestellte Fragestellungen	begruendung	Freitext_1024	optional			documentation GRK03: Begründung der Antwort
Name	Type	Use	Default	Fixed	Annotation																				
frage_ID	Frage_ID	required			documentation GRK01: Antwort zur Fragestellung																				
antwortzeichen	Antwortzeichen	required			documentation GRK02: Antwortzeichen auf gestellte Fragestellungen																				
begruendung	Freitext_1024	optional			documentation GRK03: Begründung der Antwort																				
annotation	documentation GRK-Sätze																								
source	<pre> <xs:element name="antwort" minOccurs="0" maxOccurs="99"> <xs:annotation> <xs:documentation>GRK-Sätze</xs:documentation> </xs:annotation> <xs:complexType> <xs:attribute name="frage_ID" type="Frage_ID" use="required"> <xs:annotation> <xs:documentation>GRK01: Antwort zur Fragestellung</xs:documentation> </xs:annotation> </xs:attribute> <xs:attribute name="antwortzeichen" type="Antwortzeichen" use="required"> <xs:annotation> <xs:documentation>GRK02: Antwortzeichen auf gestellte Fragestellungen</xs:documentation> </xs:annotation> </xs:attribute> <xs:attribute name="begruendung" type="Freitext_1024" use="optional"> <xs:annotation> <xs:documentation>GRK03: Begründung der Antwort</xs:documentation> </xs:annotation> </xs:attribute> </xs:complexType> </xs:element> </pre>																								

	<pre> </xs:annotati on> </xs:attri bute> </xs:compl exType> </xs:el ement> </pre>
--	---

attribute CT_Antworten/antwort/@frage_ID

type	Frage_ID									
properties	use required									
facets	<table border="1"> <thead> <tr> <th>Kind</th> <th>Value</th> <th>Annotation</th> </tr> </thead> <tbody> <tr> <td>length</td> <td>2</td> <td></td> </tr> <tr> <td>pattern</td> <td>[0-9][0-9]</td> <td></td> </tr> </tbody> </table>	Kind	Value	Annotation	length	2		pattern	[0-9][0-9]	
Kind	Value	Annotation								
length	2									
pattern	[0-9][0-9]									
annotation	documentation GRK01: Antwort zur Fragestellung									
source	<pre> <xs:attri bute name="frage_ID" type="Frage_ID" use="requi red"> <xs:annotati on> <xs:documentati on>GRK01: Antwort zur Fragestel lung</xs:documentati on> </xs:annotati on> </xs:attri bute> </pre>									

attribute CT_Antworten/antwort/@antwortzeichen

type	Antwortzeichen															
properties	use required															
facets	<table border="1"> <thead> <tr> <th>Kind</th> <th>Value</th> <th>Annotation</th> </tr> </thead> <tbody> <tr> <td>enumeration</td> <td>0</td> <td></td> </tr> <tr> <td>enumeration</td> <td>1</td> <td></td> </tr> <tr> <td>enumeration</td> <td>2</td> <td></td> </tr> <tr> <td>enumeration</td> <td>9</td> <td></td> </tr> </tbody> </table>	Kind	Value	Annotation	enumeration	0		enumeration	1		enumeration	2		enumeration	9	
Kind	Value	Annotation														
enumeration	0															
enumeration	1															
enumeration	2															
enumeration	9															
annotation	documentation GRK02: Antwortzeichen auf gestellte Fragestellungen															
source	<pre> <xs:attri bute name="antwortzei chen" type="Antwortzei chen" use="requi red"> <xs:annotati on> <xs:documentati on>GRK02: Antwortzei chen auf gestel lte Fragestel lungen</xs:documentati on> </xs:annotati on> </xs:attri bute> </pre>															

attribute CT_Antworten/antwort/@begrueundung

type	Freitext_1024									
properties	use optional									
facets	<table border="1"> <thead> <tr> <th>Kind</th> <th>Value</th> <th>Annotation</th> </tr> </thead> <tbody> <tr> <td>minLength</td> <td>1</td> <td></td> </tr> <tr> <td>maxLength</td> <td>1024</td> <td></td> </tr> </tbody> </table>	Kind	Value	Annotation	minLength	1		maxLength	1024	
Kind	Value	Annotation								
minLength	1									
maxLength	1024									
annotation	documentation GRK03: Begründung der Antwort									

source	<pre><xs:attribute name="begruendung" type="Frei text_1024" use="optional "> <xs:annotation> <xs:documentation>GRK03: Begründung der Antwort</xs:documentation> </xs:annotation> </xs:attribute></pre>
--------	--

complexType CT_Fragestellung

diagram	<pre>classDiagram class CT_Fragestellung { +Fragestellung der Krankenkasse } class frage { +RKH-Sätze } CT_Fragestellung "0..99" -- "*" frage</pre>
namespace	http://www.aok-systems.de/xml-schema/EMDK0-basis-3.0.0
children	frage
used by	element Beauftragung/Auftrag/Fragen
annotation	documentation Fragstellungen der Krankenkasse
source	<pre><xs:complexType name="CT_Fragestellung"> <xs:annotation> <xs:documentation>Fragstellungen der Krankenkasse</xs:documentation> </xs:annotation> <xs:sequence minOccurs="0"> <xs:element name="frage" minOccurs="0" maxOccurs="99"> <xs:annotation> <xs:documentation>RKH-Sätze</xs:documentation> </xs:annotation> <xs:complexType> <xs:attribute name="frage_ID" type="Frage_ID" use="required"> <xs:annotation> <xs:documentation>RKH01: Fragestellung</xs:documentation> </xs:annotation> </xs:attribute> <xs:attribute name="begruendung" type="Frei text_1024" use="optional "> <xs:annotation> <xs:documentation>RKH02: Begründung der Fragestellung</xs:documentation> </xs:annotation> </xs:attribute> <xs:attribute name="begruendung_intern" type="Frei text_1024" use="optional "> <xs:annotation> <xs:documentation>RKH03: Interne Begründung der Fragestellung</xs:documentation> </xs:annotation> </xs:attribute> </xs:complexType> </xs:element> </xs:sequence> </xs:complexType></pre>

element CT_Fragestellung/frage

diagram																									
namespace	http://www.aok-systems.de/xml-schema/EMDK0-basis-3.0.0																								
properties	minOcc 0 maxOcc 99 content complex																								
attributes	<table border="1"> <thead> <tr> <th>Name</th> <th>Type</th> <th>Use</th> <th>Default</th> <th>Fixed</th> <th>Annotation</th> </tr> </thead> <tbody> <tr> <td>frage_ID</td> <td>Frage_ID</td> <td>required</td> <td></td> <td></td> <td>documentation RKH01: Fragestellung</td> </tr> <tr> <td>begruendung</td> <td>Freitext_1024</td> <td>optional</td> <td></td> <td></td> <td>documentation RKH02: Begründung der Fragestellung</td> </tr> <tr> <td>begruendung_intern</td> <td>Freitext_1024</td> <td>optional</td> <td></td> <td></td> <td>documentation RKH03: Interne Begründung der Fragestellung</td> </tr> </tbody> </table>	Name	Type	Use	Default	Fixed	Annotation	frage_ID	Frage_ID	required			documentation RKH01: Fragestellung	begruendung	Freitext_1024	optional			documentation RKH02: Begründung der Fragestellung	begruendung_intern	Freitext_1024	optional			documentation RKH03: Interne Begründung der Fragestellung
Name	Type	Use	Default	Fixed	Annotation																				
frage_ID	Frage_ID	required			documentation RKH01: Fragestellung																				
begruendung	Freitext_1024	optional			documentation RKH02: Begründung der Fragestellung																				
begruendung_intern	Freitext_1024	optional			documentation RKH03: Interne Begründung der Fragestellung																				
annotation	documentation RKH-Sätze																								
source	<pre> <xs:element name="frage" minOccurs="0" maxOccurs="99"> <xs:annotation> <xs:documentation>RKH-Sätze</xs:documentation> </xs:annotation> <xs:complexType> <xs:attribute name="frage_ID" type="Frage_ID" use="required"> <xs:annotation> <xs:documentation>RKH01: Fragestellung</xs:documentation> </xs:annotation> </xs:attribute> <xs:attribute name="begruendung" type="Freitext_1024" use="optional"> <xs:annotation> <xs:documentation>RKH02: Begründung der Fragestellung</xs:documentation> </xs:annotation> </xs:attribute> <xs:attribute name="begruendung_intern" type="Freitext_1024" use="optional"> <xs:annotation> <xs:documentation>RKH03: Interne Begründung der Fragestellung</xs:documentation> </xs:annotation> </xs:attribute> </xs:complexType> </xs:element> </pre>																								

	<pre> </xs:attribute> </xs:complexType> </xs:element> </pre>
--	--

attribute CT_Fragestellung/frage/@frage_ID

type	Frage_ID									
properties	use required									
facets	<table border="1"> <thead> <tr> <th>Kind</th> <th>Value</th> <th>Annotation</th> </tr> </thead> <tbody> <tr> <td>length</td> <td>2</td> <td></td> </tr> <tr> <td>pattern</td> <td>[0-9][0-9]</td> <td></td> </tr> </tbody> </table>	Kind	Value	Annotation	length	2		pattern	[0-9][0-9]	
Kind	Value	Annotation								
length	2									
pattern	[0-9][0-9]									
annotation	documentation RKH01: Fragestellung									
source	<pre> <xs:attribute name="frage_ID" type="Frage_ID" use="required"> <xs:annotation> <xs:documentation>RKH01: Fragestellung</xs:documentation> </xs:annotation> </xs:attribute> </pre>									

attribute CT_Fragestellung/frage/@begrueundung

type	Freitext_1024									
properties	use optional									
facets	<table border="1"> <thead> <tr> <th>Kind</th> <th>Value</th> <th>Annotation</th> </tr> </thead> <tbody> <tr> <td>minLength</td> <td>1</td> <td></td> </tr> <tr> <td>maxLength</td> <td>1024</td> <td></td> </tr> </tbody> </table>	Kind	Value	Annotation	minLength	1		maxLength	1024	
Kind	Value	Annotation								
minLength	1									
maxLength	1024									
annotation	documentation RKH02: Begründung der Fragestellung									
source	<pre> <xs:attribute name="begrueundung" type="Freitext_1024" use="optional"> <xs:annotation> <xs:documentation>RKH02: Begründung der Fragestellung</xs:documentation> </xs:annotation> </xs:attribute> </pre>									

attribute CT_Fragestellung/frage/@begrueundung_intern

type	Freitext_1024									
properties	use optional									
facets	<table border="1"> <thead> <tr> <th>Kind</th> <th>Value</th> <th>Annotation</th> </tr> </thead> <tbody> <tr> <td>minLength</td> <td>1</td> <td></td> </tr> <tr> <td>maxLength</td> <td>1024</td> <td></td> </tr> </tbody> </table>	Kind	Value	Annotation	minLength	1		maxLength	1024	
Kind	Value	Annotation								
minLength	1									
maxLength	1024									
annotation	documentation RKH03: Interne Begründung der Fragestellung									
source	<pre> <xs:attribute name="begrueundung_intern" type="Freitext_1024" use="optional"> <xs:annotation> <xs:documentation>RKH03: Interne Begründung der Fragestellung</xs:documentation> </xs:annotation> </xs:attribute> </pre>									

	<pre></xs: annotation> </xs: attribute></pre>
--	---

complexType CT_Neuer_Pruefanlass

diagram	<pre> classDiagram class CT_Neuer_Pruefanlass { +Fragestellungen des MD } class frage { +RKH-Sätze } CT_Neuer_Pruefanlass "1" -- "0..99" frage </pre>
namespace	http://www.aok-systems.de/xml-schema/EMDK0-basis-3.0.0
children	frage
used by	elements Begutachtung/Zwischennachricht/Fragen Begutachtung/Zwischennachricht_ZEP/Fragen
annotation	documentation Fragestellungen des MD
source	<pre><xs:complexType name="CT_Neuer_Pruefanlass"> <xs:annotation> <xs:documentation>Fragestellungen des MD</xs:documentation> </xs:annotation> <xs:sequence minOccurs="0"> <xs:element name="frage" minOccurs="0" maxOccurs="99"> <xs:annotation> <xs:documentation>RKH-Sätze</xs:documentation> </xs:annotation> <xs:complexType> <xs:attribute name="frage_ID" type="Frage_ID" use="required"> <xs:annotation> <xs:documentation>RKH01: Fragestellung</xs:documentation> </xs:annotation> </xs:attribute> <xs:attribute name="begruendung" type="Frei text_1024" use="optional"> <xs:annotation> <xs:documentation>RKH02: Begründung der Fragestellung</xs:documentation> </xs:annotation> </xs:attribute> <xs:attribute name="begruendung_intern" type="Frei text_1024" use="optional"> <xs:annotation> <xs:documentation>RKH03: Interne Begründung der Fragestellung</xs:documentation> </xs:annotation> </xs:attribute> </xs:complexType> </xs:element> </xs:sequence> </xs:complexType></pre>

element CT_Neuer_Pruefanlass/frage

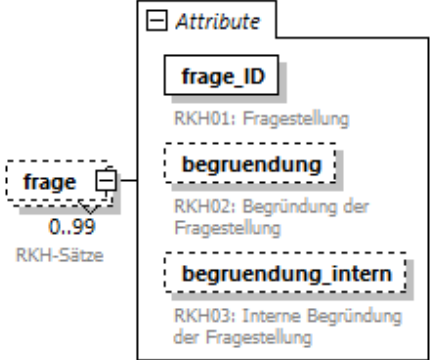
diagram																									
namespace	http://www.aok-systems.de/xml-schema/EMDK0-basis-3.0.0																								
properties	minOcc 0 maxOcc 99 content complex																								
attributes	<table border="1"> <thead> <tr> <th>Name</th> <th>Type</th> <th>Use</th> <th>Default</th> <th>Fixed</th> <th>Annotation</th> </tr> </thead> <tbody> <tr> <td>frage_ID</td> <td>Frage_ID</td> <td>required</td> <td></td> <td></td> <td>documentation RKH01: Fragestellung</td> </tr> <tr> <td>begruendung</td> <td>Freitext_1024</td> <td>optional</td> <td></td> <td></td> <td>documentation RKH02: Begründung der Fragestellung</td> </tr> <tr> <td>begruendung_intern</td> <td>Freitext_1024</td> <td>optional</td> <td></td> <td></td> <td>documentation RKH03: Interne Begründung der Fragestellung</td> </tr> </tbody> </table>	Name	Type	Use	Default	Fixed	Annotation	frage_ID	Frage_ID	required			documentation RKH01: Fragestellung	begruendung	Freitext_1024	optional			documentation RKH02: Begründung der Fragestellung	begruendung_intern	Freitext_1024	optional			documentation RKH03: Interne Begründung der Fragestellung
Name	Type	Use	Default	Fixed	Annotation																				
frage_ID	Frage_ID	required			documentation RKH01: Fragestellung																				
begruendung	Freitext_1024	optional			documentation RKH02: Begründung der Fragestellung																				
begruendung_intern	Freitext_1024	optional			documentation RKH03: Interne Begründung der Fragestellung																				
annotation	documentation RKH-Sätze																								
source	<pre><xs:element name="frage" minOccurs="0" maxOccurs="99"> <xs:annotation> <xs:documentation>RKH-Sätze</xs:documentation> </xs:annotation> <xs:complexType> <xs:attribute name="frage_ID" type="Frage_ID" use="required"> <xs:annotation> <xs:documentation>RKH01: Fragestellung</xs:documentation> </xs:annotation> </xs:attribute> <xs:attribute name="begruendung" type="Freitext_1024" use="optional"> <xs:annotation> <xs:documentation>RKH02: Begründung der Fragestellung</xs:documentation> </xs:annotation> </xs:attribute> <xs:attribute name="begruendung_intern" type="Freitext_1024" use="optional"> <xs:annotation> <xs:documentation>RKH03: Interne Begründung der Fragestellung</xs:documentation> </xs:annotation> </xs:attribute> </xs:complexType> </xs:element></pre>																								

	<pre></xs:complexType> </xs:element></pre>
--	--

attribute CT_Neuer_Pruefanlass/frage/@frage_ID

type	Frage_ID									
properties	use required									
facets	<table border="1"> <thead> <tr> <th>Kind</th> <th>Value</th> <th>Annotation</th> </tr> </thead> <tbody> <tr> <td>length</td> <td>2</td> <td></td> </tr> <tr> <td>pattern</td> <td>[0-9][0-9]</td> <td></td> </tr> </tbody> </table>	Kind	Value	Annotation	length	2		pattern	[0-9][0-9]	
Kind	Value	Annotation								
length	2									
pattern	[0-9][0-9]									
annotation	documentation RKH01: Fragestellung									
source	<pre><xs:attribute name="frage_ID" type="Frage_ID" use="required"> <xs:annotation> <xs:documentation>RKH01: Fragestellung</xs:documentation> </xs:annotation> </xs:attribute></pre>									

attribute CT_Neuer_Pruefanlass/frage/@begruendung

type	Freitext_1024									
properties	use optional									
facets	<table border="1"> <thead> <tr> <th>Kind</th> <th>Value</th> <th>Annotation</th> </tr> </thead> <tbody> <tr> <td>minLength</td> <td>1</td> <td></td> </tr> <tr> <td>maxLength</td> <td>1024</td> <td></td> </tr> </tbody> </table>	Kind	Value	Annotation	minLength	1		maxLength	1024	
Kind	Value	Annotation								
minLength	1									
maxLength	1024									
annotation	documentation RKH02: Begründung der Fragestellung									
source	<pre><xs:attribute name="begruendung" type="Freitext_1024" use="optional"> <xs:annotation> <xs:documentation>RKH02: Begründung der Fragestellung</xs:documentation> </xs:annotation> </xs:attribute></pre>									

attribute CT_Neuer_Pruefanlass/frage/@begruendung_intern

type	Freitext_1024									
properties	use optional									
facets	<table border="1"> <thead> <tr> <th>Kind</th> <th>Value</th> <th>Annotation</th> </tr> </thead> <tbody> <tr> <td>minLength</td> <td>1</td> <td></td> </tr> <tr> <td>maxLength</td> <td>1024</td> <td></td> </tr> </tbody> </table>	Kind	Value	Annotation	minLength	1		maxLength	1024	
Kind	Value	Annotation								
minLength	1									
maxLength	1024									
annotation	documentation RKH03: Interne Begründung der Fragestellung									
source	<pre><xs:attribute name="begruendung_intern" type="Freitext_1024" use="optional"> <xs:annotation> <xs:documentation>RKH03: Interne Begründung der Fragestellung</xs:documentation> </xs:annotation></pre>									

	<code></xs:attribute></code>
--	------------------------------------

complexType CT_Pruefgegenstand

diagram	
namespace	http://www.aok-systems.de/xml-schema/EMDK0-basis-3.0.0
children	Pruefgegenstand
used by	elements Beauftragung/Auftrag/Infos/Pruefgegenstaende Begutachtung/Zwischennachricht/Pruefgegenstaende Begutachtung/Zwischennachricht_ZEP/Pruefgegenstaende
annotation	documentation Prüfgegenstand
source	<pre><xs:complexType name="CT_Pruefgegenstand"> <xs:annotation> <xs:documentation>Prüfgegenstand</xs:documentation> </xs:annotation> <xs:sequence minOccurs="0"> <xs:element name="Pruefgegenstand" minOccurs="0" maxOccurs="5"> <xs:complexType> <xs:attribute name="pruefgegenstand" type="Pruefgegenstand" use="required"/> <xs:annotation> <xs:documentation>PGS01: Prüfgegenstand</xs:documentation> </xs:annotation> </xs:complexType> </xs:element> </xs:sequence> </xs:complexType></pre>

element CT_Pruefgegenstand/Pruefgegenstand

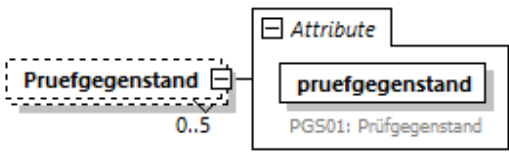
diagram													
namespace	http://www.aok-systems.de/xml-schema/EMDK0-basis-3.0.0												
properties	minOcc 0 maxOcc 5 content complex												
attributes	<table border="1"> <thead> <tr> <th>Name</th> <th>Type</th> <th>Use</th> <th>Default</th> <th>Fixed</th> <th>Annotation</th> </tr> </thead> <tbody> <tr> <td>pruefgegenstand</td> <td>Pruefgegenstand</td> <td>required</td> <td></td> <td></td> <td>documentation PGS01: Prüfgegenstand</td> </tr> </tbody> </table>	Name	Type	Use	Default	Fixed	Annotation	pruefgegenstand	Pruefgegenstand	required			documentation PGS01: Prüfgegenstand
Name	Type	Use	Default	Fixed	Annotation								
pruefgegenstand	Pruefgegenstand	required			documentation PGS01: Prüfgegenstand								
source	<pre><xs:element name="Pruefgegenstand" minOccurs="0" maxOccurs="5"> <xs:complexType></pre>												

	<pre> <xs:attribute name="pruefgegenstand" type="Pruefgegenstand" use="required"> <xs:annotation> <xs:documentation>PGS01: Prüfgegenstand</xs:documentation> </xs:annotation> </xs:attribute> </xs:complexType> </xs:element> </pre>
--	--

attribute CT_Pruefgegenstand/Pruefgegenstand/@pruefgegenstand

type	Pruefgegenstand																		
properties	use required																		
facets	<table border="1"> <thead> <tr> <th>Kind</th> <th>Value</th> <th>Annotation</th> </tr> </thead> <tbody> <tr> <td>enumeration</td> <td>1</td> <td></td> </tr> <tr> <td>enumeration</td> <td>2</td> <td></td> </tr> <tr> <td>enumeration</td> <td>3</td> <td></td> </tr> <tr> <td>enumeration</td> <td>4</td> <td></td> </tr> <tr> <td>enumeration</td> <td>5</td> <td></td> </tr> </tbody> </table>	Kind	Value	Annotation	enumeration	1		enumeration	2		enumeration	3		enumeration	4		enumeration	5	
Kind	Value	Annotation																	
enumeration	1																		
enumeration	2																		
enumeration	3																		
enumeration	4																		
enumeration	5																		
annotation	documentation PGS01: Prüfgegenstand																		
source	<pre> <xs:attribute name="pruefgegenstand" type="Pruefgegenstand" use="required"> <xs:annotation> <xs:documentation>PGS01: Prüfgegenstand</xs:documentation> </xs:annotation> </xs:attribute> </pre>																		

simpleType Abrechnungsart

namespace	http://www.aok-systems.de/xml-schema/EMDK0-basis-3.0.0												
type	restriction of xs:string												
properties	base xs:string												
used by	attributes Beauftragung/Auftrag/@geltungsbereich Begutachtung/Stellungnahme/@geltungsbereich												
facets	<table border="1"> <thead> <tr> <th>Kind</th> <th>Value</th> <th>Annotation</th> </tr> </thead> <tbody> <tr> <td>enumeration</td> <td>01</td> <td></td> </tr> <tr> <td>enumeration</td> <td>02</td> <td></td> </tr> <tr> <td>enumeration</td> <td>09</td> <td></td> </tr> </tbody> </table>	Kind	Value	Annotation	enumeration	01		enumeration	02		enumeration	09	
Kind	Value	Annotation											
enumeration	01												
enumeration	02												
enumeration	09												
annotation	documentation Schlüssel A: Gesetzlicher Geltungsbereich der Abrechnung 01 = BpflV nach § 17d KHG (PEPP) 02 = KHEntgG nach § 17b KHG (DRG) 09 = sonstige (wird erst zu einem späteren Zeitpunkt verwendet)												
source	<pre> <xs:simpleType name="Abrechnungsart"> <xs:annotation> <xs:documentation>Schlüssel A: Gesetzlicher Geltungsbereich der Abrechnung 01 = BpflV nach § 17d KHG (PEPP) 02 = KHEntgG nach § 17b KHG (DRG) 09 = sonstige (wird erst zu einem späteren Zeitpunkt verwendet) </xs:documentation> </xs:annotation> </xs:simpleType> </pre>												

	<pre> </xs:documentation> </xs:annotation> <xs:restriction base="xs:string"> <xs:enumeration value="01"/> <xs:enumeration value="02"/> <xs:enumeration value="09"/> </xs:restriction> </xs:simpleType> </pre>
--	---

simpleType Antwortzeichen

namespace	http://www.aok-systems.de/xml-schema/EMDK0-basis-3.0.0															
type	restriction of xs:string															
properties	base xs:string															
used by	attributes Begutachtung/Stellungnahme/Pruefung/Diagnosen/Diagnose/MD/@antwort Begutachtung/Stellungnahme/Pruefung/Prozeduren/Prozedur/MD/@antwort Begutachtung/Stellungnahme/Pruefung/Entgelte/MD/@antwort CT_Antworten/antwort/@antwortzeichen															
facets	<table border="1"> <thead> <tr> <th>Kind</th> <th>Value</th> <th>Annotation</th> </tr> </thead> <tbody> <tr> <td>enumeration</td> <td>0</td> <td></td> </tr> <tr> <td>enumeration</td> <td>1</td> <td></td> </tr> <tr> <td>enumeration</td> <td>2</td> <td></td> </tr> <tr> <td>enumeration</td> <td>9</td> <td></td> </tr> </tbody> </table>	Kind	Value	Annotation	enumeration	0		enumeration	1		enumeration	2		enumeration	9	
Kind	Value	Annotation														
enumeration	0															
enumeration	1															
enumeration	2															
enumeration	9															
annotation	documentation Schlüssel H: Antwortzeichen auf gestellte Fragestellungen 0 = nicht bestätigt 1 = bestätigt 2 = andere Antwort 9 = keine Antwort															
source	<pre> <xs:simpleType name="Antwortzeichen"> <xs:annotation> <xs:documentation>Schlüssel H: Antwortzeichen auf gestellte Fragestellungen 0 = nicht bestätigt 1 = bestätigt 2 = andere Antwort 9 = keine Antwort </xs:documentation> </xs:annotation> <xs:restriction base="xs:string"> <xs:enumeration value="0"/> <xs:enumeration value="1"/> <xs:enumeration value="2"/> <xs:enumeration value="9"/> </xs:restriction> </xs:simpleType> </pre>															

simpleType Anzahl_Tage3

namespace	http://www.aok-systems.de/xml-schema/EMDK0-basis-3.0.0
-----------	--

type	restriction of xs:int									
properties	base xs:int									
used by	<p>elements Beauftragung/Auftrag/Infos/Entlassung/TOB Begutachtung/Stellungnahme/Pruefung/Entlassung/TOB</p> <p>attributes Beauftragung/Auftrag/Infos/Entgelte/@entgelt_anzahl Begutachtung/Stellungnahme/Pruefung/Entgelte/KH/@entgelt_anzahl Begutachtung/Stellungnahme/Pruefung/Entgelte/MD/@entgelt_anzahl Beauftragung/Auftrag/Infos/Entgelte/@TOB Begutachtung/Stellungnahme/Pruefung/Entgelte/KH/@TOB Begutachtung/Stellungnahme/Pruefung/Entgelte/MD/@TOB</p>									
facets	<table border="1"> <thead> <tr> <th>Kind</th> <th>Value</th> <th>Annotation</th> </tr> </thead> <tbody> <tr> <td>minInclusive</td> <td>0</td> <td></td> </tr> <tr> <td>maxInclusive</td> <td>999</td> <td></td> </tr> </tbody> </table>	Kind	Value	Annotation	minInclusive	0		maxInclusive	999	
Kind	Value	Annotation								
minInclusive	0									
maxInclusive	999									
annotation	documentation Abstrakte Dauer									
source	<pre><xs:simpleType name="Anzahl_Tage3"> <xs:annotation> <xs:documentation>Abstrakte Dauer</xs:documentation> </xs:annotation> <xs:restriction base="xs:int"> <xs:minInclusive value="0"/> <xs:maxInclusive value="999"/> </xs:restriction> </xs:simpleType></pre>									

simpleType Art_Begutachtung

namespace	http://www.aok-systems.de/xml-schema/EMDK0-basis-3.0.0									
type	restriction of xs:string									
properties	base xs:string									
used by	attribute Begutachtung/Stellungnahme/@art_begutachtung									
facets	<table border="1"> <thead> <tr> <th>Kind</th> <th>Value</th> <th>Annotation</th> </tr> </thead> <tbody> <tr> <td>enumeration</td> <td>1</td> <td></td> </tr> <tr> <td>enumeration</td> <td>2</td> <td></td> </tr> </tbody> </table>	Kind	Value	Annotation	enumeration	1		enumeration	2	
Kind	Value	Annotation								
enumeration	1									
enumeration	2									
annotation	documentation Schlüssel S: Art der Begutachtung 1 = Aktenlage 2 = Begehung									
source	<pre><xs:simpleType name="Art_Begutachtung"> <xs:annotation> <xs:documentation>Schlüssel S: Art der Begutachtung 1 = Aktenlage 2 = Begehung </xs:documentation> </xs:annotation> <xs:restriction base="xs:string"> <xs:enumeration value="1"/> <xs:enumeration value="2"/> </xs:restriction> </xs:simpleType></pre>									

	<code></xs:simpleType></code>
--	-------------------------------------

simpleType Arztnummer

namespace	http://www.aok-systems.de/xml-schema/EMDK0-basis-3.0.0									
type	restriction of xs:string									
properties	base xs:string									
used by	elements Beauftragung/Auftrag/Infos/Falldaten/Arztnummer Beauftragung/Auftrag/Infos/Falldaten/Zahnarztnummer									
facets	<table border="1"> <thead> <tr> <th>Kind</th> <th>Value</th> <th>Annotation</th> </tr> </thead> <tbody> <tr> <td>maxLength</td> <td>9</td> <td></td> </tr> <tr> <td>pattern</td> <td>[0-9]+</td> <td></td> </tr> </tbody> </table>	Kind	Value	Annotation	maxLength	9		pattern	[0-9]+	
Kind	Value	Annotation								
maxLength	9									
pattern	[0-9]+									
annotation	documentation Arztnummer									
source	<pre><xs:simpleType name="Arztnummer"> <xs:annotation> <xs:documentation>Arztnummer</xs:documentation> </xs:annotation> <xs:restriction base="xs:string"> <xs:maxLength value="9"/> <xs:pattern value="[0-9]+"/> </xs:restriction> </xs:simpleType></pre>									

simpleType Aufnahmeanlass

namespace	http://www.aok-systems.de/xml-schema/EMDK0-basis-3.0.0																					
type	restriction of xs:string																					
properties	base xs:string																					
used by	attributes Beauftragung/Auftrag/Infos/Falldaten/Aufnahme/@aufnahmeanlass Begutachtung/Stellungnahme/Pruefung/Falldaten/Aufnahme/@aufnahmeanlass																					
facets	<table border="1"> <thead> <tr> <th>Kind</th> <th>Value</th> <th>Annotation</th> </tr> </thead> <tbody> <tr> <td>enumeration</td> <td>E</td> <td></td> </tr> <tr> <td>enumeration</td> <td>Z</td> <td></td> </tr> <tr> <td>enumeration</td> <td>N</td> <td></td> </tr> <tr> <td>enumeration</td> <td>R</td> <td></td> </tr> <tr> <td>enumeration</td> <td>V</td> <td></td> </tr> <tr> <td>enumeration</td> <td>A</td> <td></td> </tr> </tbody> </table>	Kind	Value	Annotation	enumeration	E		enumeration	Z		enumeration	N		enumeration	R		enumeration	V		enumeration	A	
Kind	Value	Annotation																				
enumeration	E																					
enumeration	Z																					
enumeration	N																					
enumeration	R																					
enumeration	V																					
enumeration	A																					
annotation	documentation Schlüssel K: Aufnahmeanlass E = Einweisung durch einen Arzt Z = Einweisung durch einen Zahnarzt N = Notfall R = Aufnahme nach vorausgehender Behandlung in einer Rehabilitationseinrichtung V = Verlegung mit Behandlungsdauer im verlegenden Krankenhaus länger als 24 Stunden A = Verlegung mit Behandlungsdauer im verlegenden Krankenhaus bis zu 24 Stunden																					
source	<code><xs:simpleType name="Aufnahmeanlass"></code>																					

	<pre> <xs: annotation> <xs: documentation>Schlüssel K: Aufnahmeanlass E = Einweisung durch einen Arzt Z = Einweisung durch einen Zahnarzt N = Notfall R = Aufnahme nach vorausgehender Behandlung in einer Rehabilitationsrichtung V = Verlegung mit Behandlungsdauer im verlegenden Krankenhaus länger als 24 Stunden A = Verlegung mit Behandlungsdauer im verlegenden Krankenhaus bis zu 24 Stunden </xs: documentation> </xs: annotation> <xs: restriction base="xs:string"> <xs: enumeration value="E" /> <xs: enumeration value="Z" /> <xs: enumeration value="N" /> <xs: enumeration value="R" /> <xs: enumeration value="V" /> <xs: enumeration value="A" /> </xs: restriction> </xs: simpleType> </pre>
--	--

simpleType Aufnahmegrund

namespace	http://www.aok-systems.de/xml-schema/EMDK0-basis-3.0.0									
type	restriction of xs:string									
properties	base xs:string									
used by	attributes Beauftragung/Auftrag/Infos/Falldaten/Aufnahme/@aufnahmegrund Begutachtung/Stellungnahme/Pruefung/Falldaten/Aufnahme/@aufnahmegrund									
facets	<table border="1"> <thead> <tr> <th>Kind</th> <th>Value</th> <th>Annotation</th> </tr> </thead> <tbody> <tr> <td>length</td> <td>4</td> <td></td> </tr> <tr> <td>pattern</td> <td>(0[1-9] 10 11)[024][1-8]</td> <td></td> </tr> </tbody> </table>	Kind	Value	Annotation	length	4		pattern	(0[1-9] 10 11)[024][1-8]	
Kind	Value	Annotation								
length	4									
pattern	(0[1-9] 10 11)[024][1-8]									
annotation	documentation TA301 Schlüssel 1: Aufnahmegrund									
source	<pre> <xs: simpleType name="Aufnahmegrund"> <xs: annotation> <xs: documentation>TA301 Schlüssel 1: Aufnahmegrund</xs: documentation> </xs: annotation> <xs: restriction base="xs:string"> <xs: length value="4" /> <xs: pattern value="(0[1-9] 10 11)[024][1-8]" /> </xs: restriction> </xs: simpleType> </pre>									

simpleType Auftragsart

namespace	http://www.aok-systems.de/xml-schema/EMDK0-basis-3.0.0
type	restriction of xs:string

properties	base xs:string																																				
used by	attributes Beauftragung/Auftrag/@auftragsart Beauftragung/Storno/@auftragsart																																				
facets	<table border="1"> <thead> <tr> <th>Kind</th> <th>Value</th> <th>Annotation</th> </tr> </thead> <tbody> <tr><td>enumeration</td><td>01</td><td></td></tr> <tr><td>enumeration</td><td>02</td><td></td></tr> <tr><td>enumeration</td><td>03</td><td></td></tr> <tr><td>enumeration</td><td>04</td><td></td></tr> <tr><td>enumeration</td><td>05</td><td></td></tr> <tr><td>enumeration</td><td>06</td><td></td></tr> <tr><td>enumeration</td><td>07</td><td></td></tr> <tr><td>enumeration</td><td>08</td><td></td></tr> <tr><td>enumeration</td><td>09</td><td></td></tr> <tr><td>enumeration</td><td>10</td><td></td></tr> <tr><td>enumeration</td><td>11</td><td></td></tr> </tbody> </table>	Kind	Value	Annotation	enumeration	01		enumeration	02		enumeration	03		enumeration	04		enumeration	05		enumeration	06		enumeration	07		enumeration	08		enumeration	09		enumeration	10		enumeration	11	
Kind	Value	Annotation																																			
enumeration	01																																				
enumeration	02																																				
enumeration	03																																				
enumeration	04																																				
enumeration	05																																				
enumeration	06																																				
enumeration	07																																				
enumeration	08																																				
enumeration	09																																				
enumeration	10																																				
enumeration	11																																				
annotation	documentation Schlüssel B: Art des Auftrages 01 = Erstauftrag 02 = Folgeauftrag ohne Datenkorrektur 03 = Widerspruchsauftrag / Auftrag im Nachverfahren der Prüfv 04 = Persönliche SFB in der Geschäftsstelle der Krankenkasse oder des MD 05 = Schriftliche Sozialmedizinische Fallberatung (SFB) per Aktenlage 06 = Folgeauftrag nach Datenkorrektur ohne Prüferweiterung 07 = Folgeauftrag nach Datenkorrektur mit Prüferweiterung 08 = Stornierung ohne Folgeauftrag 09 = Stornierung mit Folgeauftrag 10 = Folgeauftrag mit Fristverlängerung für Unterlagen 11 = Sozialgerichtsverfahren																																				
source	<pre> <xs:simpleType name="Auftragsart"> <xs:annotation> <xs:documentation>Schlüssel B: Art des Auftrages 01 = Erstauftrag 02 = Folgeauftrag ohne Datenkorrektur 03 = Widerspruchsauftrag / Auftrag im Nachverfahren der Prüfv 04 = Persönliche SFB in der Geschäftsstelle der Krankenkasse oder des MD 05 = Schriftliche Sozialmedizinische Fallberatung (SFB) per Aktenlage 06 = Folgeauftrag nach Datenkorrektur ohne Prüferweiterung 07 = Folgeauftrag nach Datenkorrektur mit Prüferweiterung 08 = Stornierung ohne Folgeauftrag 09 = Stornierung mit Folgeauftrag 10 = Folgeauftrag mit Fristverlängerung für Unterlagen 11 = Sozialgerichtsverfahren </xs:documentation> </xs:annotation> <xs:restriction base="xs:string"> <xs:enumeration value="01"/> <xs:enumeration value="02"/> <xs:enumeration value="03"/> <xs:enumeration value="04"/> <xs:enumeration value="05"/> </xs:restriction> </xs:simpleType> </pre>																																				

	<pre> <xs:enumeration value="06"/> <xs:enumeration value="07"/> <xs:enumeration value="08"/> <xs:enumeration value="09"/> <xs:enumeration value="10"/> <xs:enumeration value="11"/> </xs:restriction> </xs:simpleType> </pre>
--	---

simpleType Behandlungsart

namespace	http://www.aok-systems.de/xml-schema/EMDK0-basis-3.0.0																					
type	restriction of xs:string																					
properties	base xs:string																					
used by	element Beauftragung/Auftrag/Infos/Falldaten/Behandlungsart																					
facets	<table border="1"> <thead> <tr> <th>Kind</th> <th>Value</th> <th>Annotation</th> </tr> </thead> <tbody> <tr> <td>enumeration</td> <td>1</td> <td></td> </tr> <tr> <td>enumeration</td> <td>2</td> <td></td> </tr> <tr> <td>enumeration</td> <td>3</td> <td></td> </tr> <tr> <td>enumeration</td> <td>4</td> <td></td> </tr> <tr> <td>enumeration</td> <td>5</td> <td></td> </tr> <tr> <td>enumeration</td> <td>6</td> <td></td> </tr> </tbody> </table>	Kind	Value	Annotation	enumeration	1		enumeration	2		enumeration	3		enumeration	4		enumeration	5		enumeration	6	
Kind	Value	Annotation																				
enumeration	1																					
enumeration	2																					
enumeration	3																					
enumeration	4																					
enumeration	5																					
enumeration	6																					
annotation	<p>documentation Schlüssel D: Behandlungsart</p> <ul style="list-style-type: none"> 1 = vollstationär 2 = teilstationär 3 = vorstationär 4 = nachstationär 5 = ambulantes Operieren 6 = stationsäquivalent 																					
source	<pre> <xs:simpleType name="Behandlungsart"> <xs:annotation> <xs:documentation>Schlüssel D: Behandlungsart 1 = vollstationär 2 = teilstationär 3 = vorstationär 4 = nachstationär 5 = ambulantes Operieren 6 = stationsäquivalent </xs:documentation> </xs:annotation> <xs:restriction base="xs:string"> <xs:enumeration value="1"/> <xs:enumeration value="2"/> <xs:enumeration value="3"/> <xs:enumeration value="4"/> <xs:enumeration value="5"/> <xs:enumeration value="6"/> </xs:restriction> </pre>																					

	<code></xs:simpleType></code>
--	-------------------------------------

simpleType Ber_Erw_Fragestellung

namespace	http://www.aok-systems.de/xml-schema/EMDK0-basis-3.0.0
type	restriction of xs:string
properties	base xs:string
used by	attributes Beauftragung/Auftrag/@ber_erw_fragestellung Begutachtung/Stellungnahme/@ber_erw_fragestellung
facets	Kind Value Annotation enumeration 1
annotation	documentation Schlüssel O: Berechtigung Erweiterung Fragestellung 1 = Die Berechtigung wird erteilt
source	<pre><xs:simpleType name="Ber_Erw_Fragestellung"> <xs:annotation> <xs:documentation>Schlüssel O: Berechtigung Erweiterung Fragestellung 1 = Die Berechtigung wird erteilt </xs:documentation> </xs:annotation> <xs:restriction base="xs:string"> <xs:enumeration value="1"/> </xs:restriction> </xs:simpleType></pre>

simpleType Berechtigung_Erweiterung_Pruefgegenstand

namespace	http://www.aok-systems.de/xml-schema/EMDK0-basis-3.0.0
type	restriction of xs:string
properties	base xs:string
used by	element Beauftragung/Zwischennachricht_ZAP/Antwort_Erweiterung_Pruefgegenstand attribute Beauftragung/Auftrag/@ber_erw_pruefgegenstand
facets	Kind Value Annotation enumeration 0 enumeration 1
annotation	documentation Schlüssel T: Berechtigung Erweiterung des Prüfgegenstandes 0 = Die Berechtigung wird nicht erteilt 1 = Die Berechtigung wird erteilt
source	<pre><xs:simpleType name="Berechtigung_Erweiterung_Pruefgegenstand"> <xs:annotation> <xs:documentation>Schlüssel T: Berechtigung Erweiterung des Prüfgegenstandes 0 = Die Berechtigung wird nicht erteilt 1 = Die Berechtigung wird erteilt </xs:documentation> </xs:annotation> <xs:restriction base="xs:string"></pre>

	<pre> <xs:enumeration value="0"/> <xs:enumeration value="1"/> </xs:restriction> </xs:simpleType> </pre>
--	---

simpleType Bereitstellung_Unterlagen

namespace	http://www.aok-systems.de/xml-schema/EMDK0-basis-3.0.0												
type	restriction of xs:string												
properties	base xs:string												
used by	element Begutachtung/Stellungnahme/Pruefung/Angef_Gelief_Unterlagen/Bereitstellung												
facets	<table border="1"> <thead> <tr> <th>Kind</th> <th>Value</th> <th>Annotation</th> </tr> </thead> <tbody> <tr> <td>enumeration</td> <td>1</td> <td></td> </tr> <tr> <td>enumeration</td> <td>2</td> <td></td> </tr> <tr> <td>enumeration</td> <td>3</td> <td></td> </tr> </tbody> </table>	Kind	Value	Annotation	enumeration	1		enumeration	2		enumeration	3	
Kind	Value	Annotation											
enumeration	1												
enumeration	2												
enumeration	3												
annotation	documentation Schlüssel U: Bereitstellung von Unterlagen 1 = Unterlage geliefert 2 = Unterlage unvollständig oder fehlerhaft geliefert 3 = Unterlage nicht geliefert												
source	<pre> <xs:simpleType name="Bereitstellung_Unterlagen"> <xs:annotation> <xs:documentation>Schlüssel U: Bereitstellung von Unterlagen 1 = Unterlage geliefert 2 = Unterlage unvollständig oder fehlerhaft geliefert 3 = Unterlage nicht geliefert </xs:documentation> </xs:annotation> <xs:restriction base="xs:string"> <xs:enumeration value="1"/> <xs:enumeration value="2"/> <xs:enumeration value="3"/> </xs:restriction> </xs:simpleType> </pre>												

simpleType Bezeichnung_Entgelt

namespace	http://www.aok-systems.de/xml-schema/EMDK0-basis-3.0.0									
type	restriction of xs:string									
properties	base xs:string									
used by	attribute Beauftragung/Auftrag/Infos/Entgelte/@bezeichnung									
facets	<table border="1"> <thead> <tr> <th>Kind</th> <th>Value</th> <th>Annotation</th> </tr> </thead> <tbody> <tr> <td>minLength</td> <td>1</td> <td></td> </tr> <tr> <td>maxLength</td> <td>1024</td> <td></td> </tr> </tbody> </table>	Kind	Value	Annotation	minLength	1		maxLength	1024	
Kind	Value	Annotation								
minLength	1									
maxLength	1024									
annotation	documentation Eine Zeichenkette, die Zeichen aus dem Zeichensatz ISO-8859-1 mit Zeilenumbrüche (CR/LF) und Tab enthält									

source	<pre> <xs:simpleType name="Bezeichnung_Entgelt"> <xs:annotation> <xs:documentation>Eine Zeichenkette, die Zeichen aus dem Zeichensatz ISO-8859-1 mit Zeilenumbrüche (CR/LF) und Tab enthält</xs:documentation> </xs:annotation> <xs:restriction base="xs:string"> <xs:minLength value="1"/> <xs:maxLength value="1024"/> </xs:restriction> </xs:simpleType> </pre>
--------	--

simpleType Diagnosetyp

namespace	http://www.aok-systems.de/xml-schema/EMDK0-basis-3.0.0															
type	restriction of xs:string															
properties	base xs:string															
used by	attributes Beauftragung/Auftrag/Infos/Diagnosen/Diagnose/@diagnosetyp Begutachtung/Stellungnahme/Pruefung/Diagnosen/Diagnose/KH/@diagnosetyp															
facets	<table border="1"> <thead> <tr> <th>Kind</th> <th>Value</th> <th>Annotation</th> </tr> </thead> <tbody> <tr> <td>enumeration</td> <td>01</td> <td></td> </tr> <tr> <td>enumeration</td> <td>02</td> <td></td> </tr> <tr> <td>enumeration</td> <td>03</td> <td></td> </tr> <tr> <td>enumeration</td> <td>04</td> <td></td> </tr> </tbody> </table>	Kind	Value	Annotation	enumeration	01		enumeration	02		enumeration	03		enumeration	04	
Kind	Value	Annotation														
enumeration	01															
enumeration	02															
enumeration	03															
enumeration	04															
annotation	documentation Schlüssel E: Diagnosentyp 01 = Einweisungsdiagnose 02 = Aufnahmediagnose 03 = Hauptdiagnose 04 = Nebendiagnose															
source	<pre> <xs:simpleType name="Diagnosetyp"> <xs:annotation> <xs:documentation>Schlüssel E: Diagnosentyp 01 = Einweisungsdiagnose 02 = Aufnahmediagnose 03 = Hauptdiagnose 04 = Nebendiagnose </xs:documentation> </xs:annotation> <xs:restriction base="xs:string"> <xs:enumeration value="01"/> <xs:enumeration value="02"/> <xs:enumeration value="03"/> <xs:enumeration value="04"/> </xs:restriction> </xs:simpleType> </pre>															

simpleType DRG

namespace	http://www.aok-systems.de/xml-schema/EMDK0-basis-3.0.0
-----------	--

type	restriction of xs:string
properties	base xs:string
used by	element Beauftragung/Auftrag/Infos/Entlassung/GKV_DRG attributes Beauftragung/Auftrag/Infos/Entlassung/KH_DRG/@DRG Begutachtung/Stellungnahme/Pruefung/Entlassung/MD_DRG/@DRG
facets	Kind Value Annotation length 4
annotation	documentation DRG
source	<pre> <xs:simpleType name="DRG"> <xs:annotation> <xs:documentation>DRG</xs:documentation> </xs:annotation> <xs:restriction base="xs:string"> <xs:length value="4"/> </xs:restriction> </xs:simpleType> </pre>

simpleType Entgeltart

namespace	http://www.aok-systems.de/xml-schema/EMDK0-basis-3.0.0
type	restriction of xs:string
properties	base xs:string
used by	element Beauftragung/Auftrag/Infos/Entlassung/Entgeltart attributes Beauftragung/Auftrag/Infos/Entgelte/@entgeltart Begutachtung/Stellungnahme/Pruefung/Entgelte/KH/@entgeltart Begutachtung/Stellungnahme/Pruefung/Entgelte/MD/@entgeltart
facets	Kind Value Annotation length 8 pattern [0-9A-Z]{8}
annotation	documentation TA301 Schlüssel 4: Entgeltarten
source	<pre> <xs:simpleType name="Entgeltart"> <xs:annotation> <xs:documentation>TA301 Schlüssel 4: Entgeltarten</xs:documentation> </xs:annotation> <xs:restriction base="xs:string"> <xs:length value="8"/> <xs:pattern value="[0-9A-Z]{8}"/> </xs:restriction> </xs:simpleType> </pre>

simpleType Entlassungsgrund

namespace	http://www.aok-systems.de/xml-schema/EMDK0-basis-3.0.0
type	restriction of xs:string
properties	base xs:string

used by	element attributes Begutachtung/Stellungnahme/Pruefung/Entlassung/Entlassungsgrund Beauftragung/Auftrag/Infos/Entlassung/@entlassungsgrund Beauftragung/Auftrag/Infos/Verlegungen/@verlegungsgrund
facets	Kind Value Annotation length 3 pattern [0-9]{3}
annotation	documentation TA301 Schlüssel 5: Entlassungs-/Verlegungsgrund
source	<pre><xs:simpleType name="Entlassungsgrund"> <xs:annotation> <xs:documentation>TA301 Schlüssel 5: Entlassungs-/Verlegungsgrund</xs:documentation> </xs:annotation> <xs:restriction base="xs:string"> <xs:length value="3" /> <xs:pattern value="[0-9]{3}" /> </xs:restriction> </xs:simpleType></pre>

simpleType Fachabteilung

namespace	http://www.aok-systems.de/xml-schema/EMDK0-basis-3.0.0
type	restriction of xs:string
properties	base xs:string
used by	attributes Beauftragung/Auftrag/Infos/Falldaten/Aufnahme/@fachabteilung Beauftragung/Auftrag/Infos/Entlassung/@fachabteilung Beauftragung/Auftrag/Infos/Verlegungen/@fachabteilung
facets	Kind Value Annotation length 4 pattern [0-9]{4}
annotation	documentation TA301 Schlüssel 6: Fachabteilungen
source	<pre><xs:simpleType name="Fachabteilung"> <xs:annotation> <xs:documentation>TA301 Schlüssel 6: Fachabteilungen</xs:documentation> </xs:annotation> <xs:restriction base="xs:string"> <xs:length value="4" /> <xs:pattern value="[0-9]{4}" /> </xs:restriction> </xs:simpleType></pre>

simpleType Fall_ID

namespace	http://www.aok-systems.de/xml-schema/EMDK0-basis-3.0.0
type	restriction of xs:string
properties	base xs:string
used by	attributes Beauftragung/Auftrag/@fall_ID Begutachtung/Stellungnahme/@fall_ID

facets	Kind Value Annotation minLength 0 maxLength 15
annotation	documentation Aufnahme-Nummer
source	<pre><xs:simpleType name="Fall_ID"> <xs:annotation> <xs:documentation>Aufnahme-Nummer</xs:documentation> </xs:annotation> <xs:restriction base="xs:string"> <xs:minLength value="0"/> <xs:maxLength value="15"/> </xs:restriction> </xs:simpleType></pre>

simpleType Frage_ID

namespace	http://www.aok-systems.de/xml-schema/EMDK0-basis-3.0.0
type	restriction of xs:string
properties	base xs:string
used by	attributes CT_Fragestellung/frage/@frage_ID CT_Neuer_Pruefanlass/frage/@frage_ID CT_Antworten/antwort/@frage_ID
facets	Kind Value Annotation length 2 pattern [0-9][0-9]
annotation	documentation Schlüssel C: Vordefinierte Fragestellungen
source	<pre><xs:simpleType name="Frage_ID"> <xs:annotation> <xs:documentation>Schlüssel C: Vordefinierte Fragestellungen</xs:documentation> </xs:annotation> <xs:restriction base="xs:string"> <xs:length value="2"/> <xs:pattern value="[0-9][0-9]"/> </xs:restriction> </xs:simpleType></pre>

simpleType Freitext_1024

namespace	http://www.aok-systems.de/xml-schema/EMDK0-basis-3.0.0
type	restriction of xs:string
properties	base xs:string
used by	elements Begutachtung/Stellungnahme/Pruefung/Angef_Gelief_Unterlagen/Anmerkungen Begutachtung/Stellungnahme/Pruefung/Angef_Gelief_Unterlagen/Unterlagen_Bezeichnung attributes CT_Fragestellung/frage/@begruendung CT_Neuer_Pruefanlass/frage/@begruendung CT_Antworten/antwort/@begruendung CT_Fragestellung/frage/@begruendung_intern CT_Neuer_Pruefanlass/frage/@begruendung_intern Beauftragung/Storno/@erlaeuterung Begutachtung/Stellungnahme/Pruefung/Diagnosen/Diagnose/MD/@erlaeuterung

	Begutachtung/Stellungnahme/Pruefung/Prozeduren/Prozedur/MD/@erlaeuterung Begutachtung/Stellungnahme/Pruefung/Entgelte/MD/@erlaeuterung Begutachtung/Stellungnahme/@erlaeuterung_rueckgabe									
facets	<table border="1"> <thead> <tr> <th>Kind</th> <th>Value</th> <th>Annotation</th> </tr> </thead> <tbody> <tr> <td>minLength</td> <td>1</td> <td></td> </tr> <tr> <td>maxLength</td> <td>1024</td> <td></td> </tr> </tbody> </table>	Kind	Value	Annotation	minLength	1		maxLength	1024	
Kind	Value	Annotation								
minLength	1									
maxLength	1024									
annotation	documentation Freitext, max. 1024 Zeichen									
source	<pre><xs:simpleType name="Frei text_1024"> <xs:annotation> <xs:documentation>Frei text, max. 1024 Zei chen</xs:documentation> </xs:annotation> <xs:restriction base="xs:string"> <xs:minLength value="1"/> <xs:maxLength value="1024"/> </xs:restriction> </xs:simpleType></pre>									

simpleType Freitext_255

namespace	http://www.aok-systems.de/xml-schema/EMDK0-basis-3.0.0									
type	restriction of xs:string									
properties	base xs:string									
facets	<table border="1"> <thead> <tr> <th>Kind</th> <th>Value</th> <th>Annotation</th> </tr> </thead> <tbody> <tr> <td>minLength</td> <td>1</td> <td></td> </tr> <tr> <td>maxLength</td> <td>255</td> <td></td> </tr> </tbody> </table>	Kind	Value	Annotation	minLength	1		maxLength	255	
Kind	Value	Annotation								
minLength	1									
maxLength	255									
annotation	documentation Freitext, max. 255 Zeichen									
source	<pre><xs:simpleType name="Frei text_255"> <xs:annotation> <xs:documentation>Frei text, max. 255 Zei chen</xs:documentation> </xs:annotation> <xs:restriction base="xs:string"> <xs:minLength value="1"/> <xs:maxLength value="255"/> </xs:restriction> </xs:simpleType></pre>									

simpleType Freitext_512

namespace	http://www.aok-systems.de/xml-schema/EMDK0-basis-3.0.0									
type	restriction of xs:string									
properties	base xs:string									
facets	<table border="1"> <thead> <tr> <th>Kind</th> <th>Value</th> <th>Annotation</th> </tr> </thead> <tbody> <tr> <td>minLength</td> <td>1</td> <td></td> </tr> <tr> <td>maxLength</td> <td>512</td> <td></td> </tr> </tbody> </table>	Kind	Value	Annotation	minLength	1		maxLength	512	
Kind	Value	Annotation								
minLength	1									
maxLength	512									
annotation	documentation Freitext, max. 512 Zeichen									

source	<pre> <xs:simpleType name="Frei text_512"> <xs:annotation> <xs:documentation>Frei text, max. 512 Zeichen</xs:documentation> </xs:annotation> <xs:restriction base="xs:string"> <xs:minLength value="1"/> <xs:maxLength value="512"/> </xs:restriction> </xs:simpleType> </pre>
--------	--

simpleType Gutachtenart

namespace	http://www.aok-systems.de/xml-schema/EMDK0-basis-3.0.0																								
type	restriction of xs:string																								
properties	base xs:string																								
used by	attributes Begutachtung/Stellungnahme/@erledigungsart Begutachtung/Zwischennachricht/Pruefantrag/@erledigungsart																								
facets	<table border="1"> <thead> <tr> <th>Kind</th> <th>Value</th> <th>Annotation</th> </tr> </thead> <tbody> <tr> <td>enumeration</td> <td>01</td> <td></td> </tr> <tr> <td>enumeration</td> <td>02</td> <td></td> </tr> <tr> <td>enumeration</td> <td>03</td> <td></td> </tr> <tr> <td>enumeration</td> <td>04</td> <td></td> </tr> <tr> <td>enumeration</td> <td>05</td> <td></td> </tr> <tr> <td>enumeration</td> <td>06</td> <td></td> </tr> <tr> <td>enumeration</td> <td>07</td> <td></td> </tr> </tbody> </table>	Kind	Value	Annotation	enumeration	01		enumeration	02		enumeration	03		enumeration	04		enumeration	05		enumeration	06		enumeration	07	
Kind	Value	Annotation																							
enumeration	01																								
enumeration	02																								
enumeration	03																								
enumeration	04																								
enumeration	05																								
enumeration	06																								
enumeration	07																								
annotation	documentation Schlüssel F: Art des Gutachtens 01 = Erstgutachten 02 = Folgegutachten 03 = Widerspruchsgutachten 04 = Persönliche SFB in der Geschäftsstelle der Krankenkasse oder des MD 05 = Schriftliche SFB per Aktenlage 06 = Keine Auftrags erledigung 07 = Gutachten im Sozialgerichtsverfahren																								
source	<pre> <xs:simpleType name="Gutachtenart"> <xs:annotation> <xs:documentation>Schlüssel F: Art des Gutachtens 01 = Erstgutachten 02 = Folgegutachten 03 = Widerspruchsgutachten 04 = Persönliche SFB in der Geschäftsstelle der Krankenkasse oder des MD 05 = Schriftliche SFB per Aktenlage 06 = Keine Auftrags erledigung 07 = Gutachten im Sozialgerichtsverfahren </xs:documentation> </xs:annotation> <xs:restriction base="xs:string"> <xs:enumeration value="01"/> <xs:enumeration value="02"/> </pre>																								

	<pre> <xs:enumeration value="03"/> <xs:enumeration value="04"/> <xs:enumeration value="05"/> <xs:enumeration value="06"/> <xs:enumeration value="07"/> </xs:restriction> </xs:simpleType> </pre>
--	--

simpleType IK_Stelle

namespace	http://www.aok-systems.de/xml-schema/EMDK0-basis-3.0.0									
type	restriction of xs:string									
properties	base xs:string									
used by	element Beauftragung/Auftrag/Infos/Falldaten/IK_Stelle									
facets	<table border="1"> <thead> <tr> <th>Kind</th> <th>Value</th> <th>Annotation</th> </tr> </thead> <tbody> <tr> <td>length</td> <td>9</td> <td></td> </tr> <tr> <td>pattern</td> <td>[0-9]{9}</td> <td></td> </tr> </tbody> </table>	Kind	Value	Annotation	length	9		pattern	[0-9]{9}	
Kind	Value	Annotation								
length	9									
pattern	[0-9]{9}									
annotation	documentation Institutionskennzeichen									
source	<pre> <xs:simpleType name="IK_Stelle"> <xs:annotation> <xs:documentation>Insti tuti onskennzei chen</xs:documentati on> </xs:annotati on> <xs:restricti on base="xs:stri ng"> <xs:length val ue="9" /> <xs:pattern val ue="[0-9]{9}" /> </xs:restricti on> </xs:simpl eType> </pre>									

simpleType Name_Stelle_Notfall

namespace	http://www.aok-systems.de/xml-schema/EMDK0-basis-3.0.0						
type	restriction of xs:string						
properties	base xs:string						
used by	element Beauftragung/Auftrag/Infos/Falldaten/Stelle_Notfall						
facets	<table border="1"> <thead> <tr> <th>Kind</th> <th>Value</th> <th>Annotation</th> </tr> </thead> <tbody> <tr> <td>maxLength</td> <td>30</td> <td></td> </tr> </tbody> </table>	Kind	Value	Annotation	maxLength	30	
Kind	Value	Annotation					
maxLength	30						
annotation	documentation Name, max. 30 Zeichen						
source	<pre> <xs:simpleType name="Name_Stelle_Notfall"> <xs:annotation> <xs:documentation>Name, max. 30 Zei chen</xs:documentati on> </xs:annotati on> <xs:restricti on base="xs:stri ng"> <xs:maxLength val ue="30" /> </xs:restricti on> </xs:simpl eType> </pre>						

simpleType OPS_Schluessel

namespace	http://www.aok-systems.de/xml-schema/EMDK0-basis-3.0.0
type	restriction of xs:string
properties	base xs:string
used by	attributes Beauftragung/Auftrag/Infos/Prozeduren/Prozedur/@ops Begutachtung/Stellungnahme/Pruefung/Prozeduren/Prozedur/KH/@ops Begutachtung/Stellungnahme/Pruefung/Prozeduren/Prozedur/MD/@ops
facets	Kind Value Annotation maxLength 11
annotation	documentation OPS-Schlüssel
source	<pre><xs:simpleType name="OPS_Schluessel"> <xs:annotation> <xs:documentation>OPS-Schlüssel </xs:documentation> </xs:annotation> <xs:restriction base="xs:string"> <xs:maxLength value="11"/> </xs:restriction> </xs:simpleType></pre>

simpleType Pruefgegenstand

namespace	http://www.aok-systems.de/xml-schema/EMDK0-basis-3.0.0
type	restriction of xs:string
properties	base xs:string
used by	attribute CT_Pruefgegenstand/Pruefgegenstand/@pruefgegenstand
facets	Kind Value Annotation enumeration 1 enumeration 2 enumeration 3 enumeration 4 enumeration 5
annotation	documentation Schlüssel R: Prüfgegenstand 1 = Primäre Fehlbelegung 2 = Sekundäre Fehlbelegung 3 = Kodierprüfung 4 = Fragen zur Voraussetzung bestimmter Maßnahmen 5 = Andere/weitere Prüfgegenstände
source	<pre><xs:simpleType name="Pruefgegenstand"> <xs:annotation> <xs:documentation>Schlüssel R: Prüfgegenstand 1 = Primäre Fehlbelegung 2 = Sekundäre Fehlbelegung 3 = Kodierprüfung </xs:documentation> </xs:annotation> <xs:restriction base="xs:string"> <xs:enumeration value="1"/> <xs:enumeration value="2"/> <xs:enumeration value="3"/> <xs:enumeration value="4"/> <xs:enumeration value="5"/> </xs:restriction> </xs:simpleType></pre>

	<p>4 = Fragen zur Voraussetzung bestimmter Maßnahmen 5 = Andere/weitere Prüfgegenstände</p> <pre> </xs:documentation> </xs:annotation> <xs:restriction base="xs:string"> <xs:enumeration value="1"/> <xs:enumeration value="2"/> <xs:enumeration value="3"/> <xs:enumeration value="4"/> <xs:enumeration value="5"/> </xs:restriction> </xs:simpleType> </pre>
--	---

simpleType Rechnungsnummer

namespace	http://www.aok-systems.de/xml-schema/EMDK0-basis-3.0.0						
type	restriction of xs:string						
properties	base xs:string						
used by	attribute Beauftragung/Auftrag/@rechnungsnummer						
facets	<table border="1"> <thead> <tr> <th>Kind</th> <th>Value</th> <th>Annotation</th> </tr> </thead> <tbody> <tr> <td>maxLength</td> <td>20</td> <td></td> </tr> </tbody> </table>	Kind	Value	Annotation	maxLength	20	
Kind	Value	Annotation					
maxLength	20						
annotation	documentation Rechnungsnummer						
source	<pre> <xs:simpleType name="Rechnungsnummer"> <xs:annotation> <xs:documentation>Rechnungsnummer</xs:documentation> </xs:annotation> <xs:restriction base="xs:string"> <xs:maxLength value="20"/> </xs:restriction> </xs:simpleType> </pre>						

simpleType Rueckgabegrund

namespace	http://www.aok-systems.de/xml-schema/EMDK0-basis-3.0.0																								
type	restriction of xs:string																								
properties	base xs:string																								
used by	attribute Begutachtung/Stellungnahme/@rueckgabe																								
facets	<table border="1"> <thead> <tr> <th>Kind</th> <th>Value</th> <th>Annotation</th> </tr> </thead> <tbody> <tr> <td>enumeration</td> <td>1</td> <td></td> </tr> <tr> <td>enumeration</td> <td>3</td> <td></td> </tr> <tr> <td>enumeration</td> <td>4</td> <td></td> </tr> <tr> <td>enumeration</td> <td>5</td> <td></td> </tr> <tr> <td>enumeration</td> <td>6</td> <td></td> </tr> <tr> <td>enumeration</td> <td>7</td> <td></td> </tr> <tr> <td>enumeration</td> <td>8</td> <td></td> </tr> </tbody> </table>	Kind	Value	Annotation	enumeration	1		enumeration	3		enumeration	4		enumeration	5		enumeration	6		enumeration	7		enumeration	8	
Kind	Value	Annotation																							
enumeration	1																								
enumeration	3																								
enumeration	4																								
enumeration	5																								
enumeration	6																								
enumeration	7																								
enumeration	8																								

	enumeration 9 enumeration 10 enumeration 11 enumeration 12
annotation	documentation Schlüssel N: Rückgabegrund ohne Auftragserledigung 1 = Stornierung durch Krankenkasse 3 = Auftrag mehrfach erteilt / Auftrag mit gleicher Fragestellung bereits bearbeitet 4 = Fallzusammenführung, Datensätze fehlen 5 = Falscher Datentransfer als Gutachten 6 = Falscher Datentransfer als SFB 7 = sonstiges 8 = Zuständigkeit anderer MD 9 = KH-Akte nicht vorhanden / Kein Unterlageneingang 10 = KH-Akte unvollständig / Unvollständiger Unterlageneingang 11 = Quartalsbezogenes Prüfkontingent ausgeschöpft 12 = Überschreitung der Anzeigefrist
source	<pre> <xs:simpleType name="Rueckgabegrund"> <xs:annotation> <xs:documentation>Schlüssel N: Rückgabegrund ohne Auftragserledigung 1 = Stornierung durch Krankenkasse 3 = Auftrag mehrfach erteilt / Auftrag mit gleicher Fragestellung bereits bearbeitet 4 = Fallzusammenführung, Datensätze fehlen 5 = Falscher Datentransfer als Gutachten 6 = Falscher Datentransfer als SFB 7 = sonstiges 8 = Zuständigkeit anderer MD 9 = KH-Akte nicht vorhanden / Kein Unterlageneingang 10 = KH-Akte unvollständig / Unvollständiger Unterlageneingang 11 = Quartalbezogenes Prüfkontingent ausgeschöpft 12 = Überschreitung der Anzeigefrist </xs:documentation> </xs:annotation> <xs:restriction base="xs:string"> <xs:enumeration value="1"/> <xs:enumeration value="3"/> <xs:enumeration value="4"/> <xs:enumeration value="5"/> <xs:enumeration value="6"/> <xs:enumeration value="7"/> <xs:enumeration value="8"/> <xs:enumeration value="9"/> <xs:enumeration value="10"/> <xs:enumeration value="11"/> <xs:enumeration value="12"/> </xs:restriction> </xs:simpleType> </pre>

simpleType Schluessel_V_Stp

namespace	http://www.aok-systems.de/xml-schema/EMDK0-basis-3.0.0
-----------	---

type	restriction of TA_Version_Stp									
properties	base md:TA_Version_Stp									
used by	attributes Beauftragung/@ta_version Begutachtung/@ta_version									
facets	<table border="0"> <tr> <td>Kind</td> <td>Value</td> <td>Annotation</td> </tr> <tr> <td>pattern</td> <td>[1-9][0-9]?^[1-9]?[0-9]</td> <td></td> </tr> <tr> <td>enumeration</td> <td>1.11</td> <td></td> </tr> </table>	Kind	Value	Annotation	pattern	[1-9][0-9]?^[1-9]?[0-9]		enumeration	1.11	
Kind	Value	Annotation								
pattern	[1-9][0-9]?^[1-9]?[0-9]									
enumeration	1.11									
annotation	documentation TA Versionsnummer									
source	<pre><xs:simpleType name="Schl uessel _V_Stp"> <xs:annotation> <xs:documentation>TA Versi onsnummer</xs:documentati on> </xs:annotation> <xs:restriction base="md:TA_Versi on_Stp"> <xs:enumerati on val ue="1. 11" /> </xs:restri cti on> </xs:simpl eType></pre>									

simpleType Verfahrenskennzeichen_Stp

namespace	http://www.aok-systems.de/xml-schema/EMDK0-basis-3.0.0									
type	restriction of xs:string									
properties	base xs:string									
used by	attributes Beauftragung/@verfahrenskennzeichen Begutachtung/@verfahrenskennzeichen									
facets	<table border="0"> <tr> <td>Kind</td> <td>Value</td> <td>Annotation</td> </tr> <tr> <td>enumeration</td> <td>EMDK0</td> <td></td> </tr> <tr> <td>enumeration</td> <td>TMDK0</td> <td></td> </tr> </table>	Kind	Value	Annotation	enumeration	EMDK0		enumeration	TMDK0	
Kind	Value	Annotation								
enumeration	EMDK0									
enumeration	TMDK0									
annotation	documentation Verfahrenskennzeichen (Transportweg)									
source	<pre><xs:simpleType name="Verfahrenskennzei chen_Stp"> <xs:annotation> <xs:documentation>Verfahrenskennzei chen (Transportweg)</xs:documentati on> </xs:annotation> <xs:restriction base="xs:string"> <xs:enumerati on val ue="EMDK0" /> <xs:enumerati on val ue="TMDK0" /> </xs:restri cti on> </xs:simpl eType></pre>									

simpleType Vorverf_Ergebnis

namespace	http://www.aok-systems.de/xml-schema/EMDK0-basis-3.0.0			
type	restriction of xs:string			
properties	base xs:string			
used by	attribute Beauftragung/Auftrag/@vorverfahren_ergebnis			
facets	<table border="0"> <tr> <td>Kind</td> <td>Value</td> <td>Annotation</td> </tr> </table>	Kind	Value	Annotation
Kind	Value	Annotation		

	enumeration A enumeration B enumeration D enumeration E
annotation	documentation Schlüssel Q: Ergebnis Vorverfahren A = Im Vorverfahren erfolgte keine Datenkorrektur oder -ergänzung B = Die Notwendigkeit zur Begutachtung durch den MD ist dadurch jedoch aus Sicht der Krankenkasse nicht entfallen D = Es wurde ein Falldialog durchgeführt, jedoch keine Einigung erzielt E = Aus Sicht der Krankenkasse bedarf es der direkten Beauftragung des MD
source	<pre> <xs:simpleType name="Vorverf_Ergebnis"> <xs:annotation> <xs:documentation>Schlüssel Q: Ergebnis Vorverfahren A = Im Vorverfahren erfolgte keine Datenkorrektur oder -ergänzung B = Die Notwendigkeit zur Begutachtung durch den MD ist dadurch jedoch aus Sicht der Krankenkasse nicht entfallen D = Es wurde ein Falldialog durchgeführt, jedoch keine Einigung erzielt E = Aus Sicht der Krankenkasse bedarf es der direkten Beauftragung des MD </xs:documentation> </xs:annotation> <xs:restriction base="xs:string"> <xs:enumeration value="A"/> <xs:enumeration value="B"/> <xs:enumeration value="D"/> <xs:enumeration value="E"/> </xs:restriction> </xs:simpleType> </pre>

simpleType Wechsel_Auftragsart

namespace	http://www.aok-systems.de/xml-schema/EMDK0-basis-3.0.0
type	restriction of xs:string
properties	base xs:string
used by	attributes Beauftragung/Auftrag/@wechsel_auftragsart Begutachtung/Stellungnahme/@wechsel_auftragsart
facets	Kind Value Annotation enumeration 0
annotation	documentation Schlüssel P: Wechsel der Auftragsart 0 = Die Berechtigung zum Wechsel der Auftragsart wird nicht erteilt
source	<pre> <xs:simpleType name="Wechsel_Auftragsart"> <xs:annotation> <xs:documentation>Schlüssel P: Wechsel der Auftragsart 0 = Die Berechtigung zum Wechsel der Auftragsart wird nicht erteilt </xs:documentation> </xs:annotation> </pre>

	<pre> <xs:restriction base="xs:string"> <xs:enumeration value="0"/> </xs:restriction> </xs:simpleType> </pre>
--	---

complexType Anschrift_Ctp

diagram	
namespace	GI4X:/xml-schema/GI4X-basis/2.0
properties	final extension
children	GI4X-basis:Strasse GI4X-basis:Hausnummer GI4X-basis:Postleitzahl GI4X-basis:Ort GI4X-basis:Land
used by	element Person_Ctp/Anschrift
annotation	documentation Anschrift einer natürlichen Person oder Institution
source	<pre> <xs:complexType name="Anschrift_Ctp" final="extension" dd:category="Anschrift / Adresse"> <xs:annotation> <xs:documentation>Anschrift einer natürlichen Person oder Institution</xs:documentation> </xs:annotation> <xs:sequence> <xs:element name="Strasse" type="GI4X-basis:Strasse_Stp" minOccurs="0"/> <xs:element name="Hausnummer" type="GI4X-basis: Hausnummer_Stp" minOccurs="0"/> <xs:element name="Postleitzahl" type="GI4X-basis: Postleitzahl_Stp" minOccurs="0"/> <xs:element name="Ort" type="GI4X-basis: Ort_Stp" minOccurs="0"/> <xs:element name="Land" type="GI4X-basis: Laenderkennzeichen_Stp" minOccurs="0"/> </xs:sequence> </xs:complexType> </pre>

element Anschrift_Ctp/Strasse

diagram	
namespace	GI4X:/xml-schema/GI4X-basis/2.0
type	GI4X-basis:Strasse_Stp

properties	minOcc 0 maxOcc 1 content simple
facets	Kind Value Annotation minLength 1 maxLength 55 pattern [-ÿ]+
source	<xs:element name="Strasse" type="GI4X-basis:Strasse_Stp" minOccurs="0"/>

element Anschrift_Ctp/Hausnummer

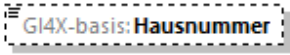
diagram	
namespace	GI4X:/xml-schema/GI4X-basis/2.0
type	GI4X-basis: Hausnummer_Stp
properties	minOcc 0 maxOcc 1 content simple
facets	Kind Value Annotation minLength 1 maxLength 15 pattern [-ÿ]+
source	<xs:element name="Hausnummer" type="GI4X-basis: Hausnummer_Stp" minOccurs="0"/>

element Anschrift_Ctp/Postleitzahl

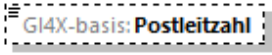
diagram	
namespace	GI4X:/xml-schema/GI4X-basis/2.0
type	GI4X-basis: Postleitzahl_Stp
properties	minOcc 0 maxOcc 1 content simple
facets	Kind Value Annotation minLength 1 maxLength 10 pattern [-ÿ]+
source	<xs:element name="Postleitzahl" type="GI4X-basis: Postleitzahl_Stp" minOccurs="0"/>

element Anschrift_Ctp/Ort

diagram	
---------	---

namespace	GI4X:/xml-schema/GI4X-basis/2.0
type	GI4X-basis:Ort_Stp
properties	minOcc 0 maxOcc 1 content simple
facets	Kind Value Annotation minLength 1 maxLength 34 pattern [-ÿ]+
source	<xs:element name="Ort" type="GI4X-basis:Ort_Stp" minOccurs="0" />

element Anschrift_Ctp/Land

diagram	
namespace	GI4X:/xml-schema/GI4X-basis/2.0
type	GI4X-basis:Laenderkennzeichen_Stp
properties	minOcc 0 maxOcc 1 content simple
facets	Kind Value Annotation minLength 1 maxLength 3 pattern [A-Z]+
source	<xs:element name="Land" type="GI4X-basis:Laenderkennzeichen_Stp" minOccurs="0" />

complexType Name_Ctp

diagram	<p>The diagram illustrates the structure of the Name_Ctp complex type. It is represented as a container box with a small square handle on the right. Inside this container, there is a smaller box with a dashed border and a small square handle on the right, representing a sequence of five elements. These elements are:</p> <ul style="list-style-type: none"> GI4X-basis:Titel: Namenstitel einer Person. GI4X-basis:Vorname: Vorname einer Person. GI4X-basis:Nachname: Nachname einer Person. GI4X-basis:Namensvorsatz: Namensvorsatz einer Person nach Anlage 6 DEÜV. GI4X-basis:Namenszusatz: Namenszusatz einer Person nach Anlage 7 DEÜV. <p>Below the container box, the text reads: "Repräsentation aller möglichen Namensbestandteile einer natürlichen Person".</p>
namespace	GI4X:/xml-schema/GI4X-basis/2.0

properties	final extension
children	GI4X-basis:Titel GI4X-basis:Vorname GI4X-basis:Nachname GI4X-basis:Namensvorsatz GI4X-basis:Namenzusatz
used by	element Person_Ctp/Name
annotation	documentation Repräsentation aller möglichen Namensbestandteile einer natürlichen Person appinfo
source	<pre> <xs:complexType name="Name_Ctp" final="extension" dd:category="Name"> <xs:annotation> <xs:documentation>Repräsentation aller möglichen Namensbestandteile einer natürlichen Person</xs:documentation> <xs:appinfo> </xs:appinfo> </xs:annotation> <xs:sequence> <xs:element name="Titel" type="GI4X-basis:Namenstiel_Stp" minOccurs="0"> <xs:annotation> <xs:documentation>Namenstiel einer Person.</xs:documentation> </xs:annotation> </xs:element> <xs:element name="Vorname" type="GI4X-basis:Vorname_Stp" minOccurs="0"> <xs:annotation> <xs:documentation>Vorname einer Person</xs:documentation> </xs:annotation> </xs:element> <xs:element name="Nachname" type="GI4X-basis:Nachname_Stp" minOccurs="0"> <xs:annotation> <xs:documentation>Nachname einer Person</xs:documentation> </xs:annotation> </xs:element> <xs:element name="Namensvorsatz" type="GI4X-basis:Namensvorsatz_Stp" minOccurs="0"> <xs:annotation> <xs:documentation>Namensvorsatz einer Person nach Anlage 6 DEÜV</xs:documentation> </xs:annotation> </xs:element> <xs:element name="Namenzusatz" type="GI4X-basis:Namenzusatz_Stp" minOccurs="0"> <xs:annotation> <xs:documentation>Namenzusatz einer Person nach Anlage 7 DEÜV</xs:documentation> </xs:annotation> </xs:element> </xs:sequence> </xs:complexType> </pre>

element Name_Ctp/Titel

diagram													
namespace	GI4X:/xml-schema/GI4X-basis/2.0												
type	GI4X-basis:Namenstitel_Stp												
properties	minOcc 0 maxOcc 1 content simple												
facets	<table border="1"> <thead> <tr> <th>Kind</th> <th>Value</th> <th>Annotation</th> </tr> </thead> <tbody> <tr> <td>minLength</td> <td>1</td> <td></td> </tr> <tr> <td>maxLength</td> <td>20</td> <td></td> </tr> <tr> <td>pattern</td> <td>[&#x0020;-&#x00FF;]+</td> <td></td> </tr> </tbody> </table>	Kind	Value	Annotation	minLength	1		maxLength	20		pattern	[-ÿ]+	
Kind	Value	Annotation											
minLength	1												
maxLength	20												
pattern	[-ÿ]+												
annotation	documentation Namenstitel einer Person.												
source	<pre><xs:element name="Titel" type="GI4X-basis:Namenstitel_Stp" minOccurs="0"> <xs:annotation> <xs:documentation>Namenstitel einer Person.</xs:documentation> </xs:annotation> </xs:element></pre>												

element Name_Ctp/Vorname

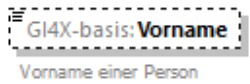
diagram													
namespace	GI4X:/xml-schema/GI4X-basis/2.0												
type	GI4X-basis:Vorname_Stp												
properties	minOcc 0 maxOcc 1 content simple												
facets	<table border="1"> <thead> <tr> <th>Kind</th> <th>Value</th> <th>Annotation</th> </tr> </thead> <tbody> <tr> <td>minLength</td> <td>1</td> <td></td> </tr> <tr> <td>maxLength</td> <td>35</td> <td></td> </tr> <tr> <td>pattern</td> <td>[&#x0020;-&#x00FF;]+</td> <td></td> </tr> </tbody> </table>	Kind	Value	Annotation	minLength	1		maxLength	35		pattern	[-ÿ]+	
Kind	Value	Annotation											
minLength	1												
maxLength	35												
pattern	[-ÿ]+												
annotation	documentation Vorname einer Person												
source	<pre><xs:element name="Vorname" type="GI4X-basis:Vorname_Stp" minOccurs="0"> <xs:annotation> <xs:documentation>Vorname einer Person</xs:documentation> </xs:annotation> </xs:element></pre>												

element Name_Ctp/Nachname

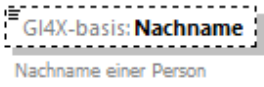
diagram													
namespace	GI4X:/xml-schema/GI4X-basis/2.0												
type	GI4X-basis:Nachname_Stp												
properties	minOcc 0 maxOcc 1 content simple												
facets	<table border="1"> <thead> <tr> <th>Kind</th> <th>Value</th> <th>Annotation</th> </tr> </thead> <tbody> <tr> <td>minLength</td> <td>1</td> <td></td> </tr> <tr> <td>maxLength</td> <td>50</td> <td></td> </tr> <tr> <td>pattern</td> <td>[&#x0020;-&#x00FF;]+</td> <td></td> </tr> </tbody> </table>	Kind	Value	Annotation	minLength	1		maxLength	50		pattern	[-ÿ]+	
Kind	Value	Annotation											
minLength	1												
maxLength	50												
pattern	[-ÿ]+												
annotation	documentation Nachname einer Person												
source	<pre><xs:element name="Nachname" type="GI4X-basis:Nachname_Stp" minOccurs="0"> <xs:annotation> <xs:documentation>Nachname einer Person</xs:documentation> </xs:annotation> </xs:element></pre>												

element Name_Ctp/Namensvorsatz

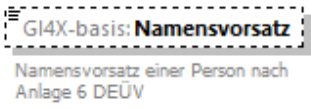
diagram													
namespace	GI4X:/xml-schema/GI4X-basis/2.0												
type	GI4X-basis:Namensvorsatz_Stp												
properties	minOcc 0 maxOcc 1 content simple												
facets	<table border="1"> <thead> <tr> <th>Kind</th> <th>Value</th> <th>Annotation</th> </tr> </thead> <tbody> <tr> <td>minLength</td> <td>1</td> <td></td> </tr> <tr> <td>maxLength</td> <td>20</td> <td></td> </tr> <tr> <td>pattern</td> <td>[&#x0020;-&#x00FF;]+</td> <td></td> </tr> </tbody> </table>	Kind	Value	Annotation	minLength	1		maxLength	20		pattern	[-ÿ]+	
Kind	Value	Annotation											
minLength	1												
maxLength	20												
pattern	[-ÿ]+												
annotation	documentation Namensvorsatz einer Person nach Anlage 6 DEÜV												
source	<pre><xs:element name="Namensvorsatz" type="GI4X-basis:Namensvorsatz_Stp" minOccurs="0"> <xs:annotation> <xs:documentation>Namensvorsatz einer Person nach Anlage 6 DEÜV</xs:documentation> </xs:annotation> </xs:element></pre>												

element Name_Ctp/Namenszusatz

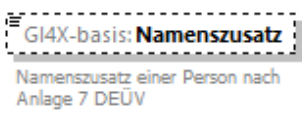
diagram													
namespace	GI4X:/xml-schema/GI4X-basis/2.0												
type	GI4X-basis: Namenszusatz_Stp												
properties	minOcc 0 maxOcc 1 content simple												
facets	<table border="1"> <thead> <tr> <th>Kind</th> <th>Value</th> <th>Annotation</th> </tr> </thead> <tbody> <tr> <td>minLength</td> <td>1</td> <td></td> </tr> <tr> <td>maxLength</td> <td>20</td> <td></td> </tr> <tr> <td>pattern</td> <td>[&#x0020;-&#x00FF;]+</td> <td></td> </tr> </tbody> </table>	Kind	Value	Annotation	minLength	1		maxLength	20		pattern	[-ÿ]+	
Kind	Value	Annotation											
minLength	1												
maxLength	20												
pattern	[-ÿ]+												
annotation	documentation Namenszusatz einer Person nach Anlage 7 DEÜV												
source	<pre><xs: element name="Namenszusatz" type="GI4X-basis: Namenszusatz_Stp" minOccurs="0"> <xs: annotation> <xs: documentation>Namenszusatz einer Person nach Anlage 7 DEÜV</xs: documentation> </xs: annotation> </xs: element></pre>												

complexType Person_Ctp

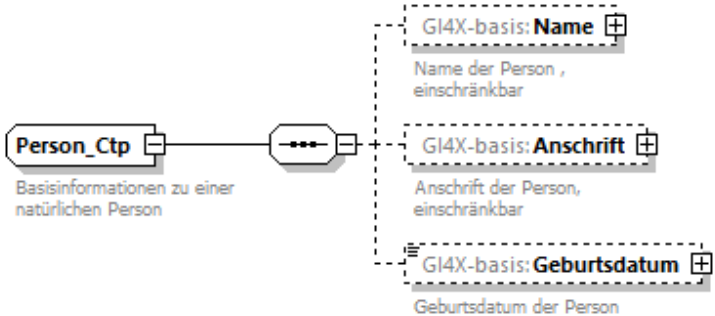
diagram	
namespace	GI4X:/xml-schema/GI4X-basis/2.0
properties	final extension
children	GI4X-basis: Name GI4X-basis: Anschrift GI4X-basis: Geburtsdatum
annotation	documentation Basisinformationen zu einer natürlichen Person
source	<pre><xs: complexType name="Person_Ctp" final="extension" dd: category="Person"> <xs: annotation> <xs: documentation>Basisinformationen zu einer natürlichen Person</xs: documentation> </xs: annotation> <xs: sequence> <xs: element name="Name" type="GI4X-basis: Name_Ctp" minOccurs="0"> <xs: annotation></pre>

```

<xs:documentation>Name der Person , einschränkbar</xs:documentation>
</xs:annotation>
</xs:element>
<xs:element name="Anschrift" type="GI4X-basis:Anschrift_Ctp" minOccurs="0">
  <xs:annotation>
    <xs:documentation>Anschrift der Person, einschränkbar</xs:documentation>
  </xs:annotation>
</xs:element>
<xs:element name="Geburtsdatum" type="GI4X-basis:UngenauesDatum_Ctp"
minOccurs="0">
  <xs:annotation>
    <xs:documentation>Geburtsdatum der Person</xs:documentation>
  </xs:annotation>
</xs:element>
</xs:sequence>
</xs:complexType>

```

element Person_Ctp/Name

diagram	
namespace	GI4X:/xml-schema/GI4X-basis/2.0
type	GI4X-basis:Name_Ctp
properties	minOcc 0 maxOcc 1 content complex
children	GI4X-basis:Titel GI4X-basis:Vorname GI4X-basis:Nachname GI4X-basis:Namensvorsatz GI4X-basis:Namenszusatz
annotation	documentation Name der Person , einschränkbar
source	<pre> <xs:element name="Name" type="GI4X-basis:Name_Ctp" minOccurs="0"> <xs:annotation> <xs:documentation>Name der Person , einschränkbar</xs:documentation> </xs:annotation> </pre>

</xs:element>

element Person_Ctp/Anschrift

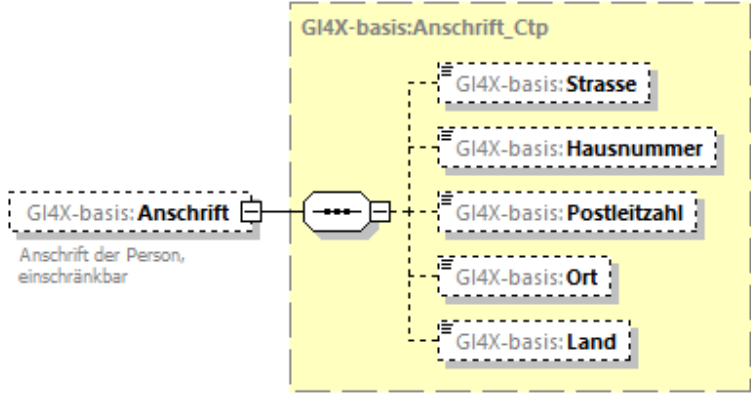
diagram	
namespace	GI4X:/xml-schema/GI4X-basis/2.0
type	GI4X-basis:Anschrift_Ctp
properties	minOcc 0 maxOcc 1 content complex
children	GI4X-basis:Strasse GI4X-basis:Hausnummer GI4X-basis:Postleitzahl GI4X-basis:Ort GI4X-basis:Land
annotation	documentation Anschrift der Person, einschränkbar
source	<pre><xs:element name="Anschrift" type="GI4X-basis:Anschrift_Ctp" minOccurs="0"> <xs:annotation> <xs:documentation>Anschrift der Person, einschränkbar</xs:documentation> </xs:annotation> </xs:element></pre>

element Person_Ctp/Geburtsdatum

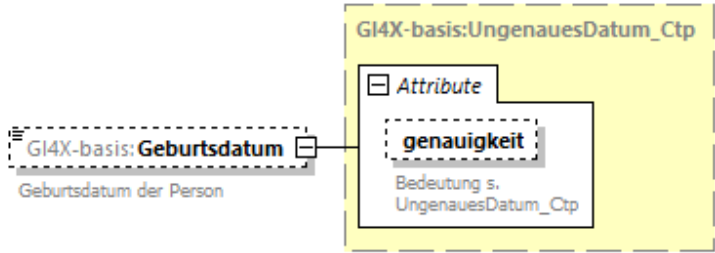
diagram	
namespace	GI4X:/xml-schema/GI4X-basis/2.0
type	GI4X-basis:UngenauesDatum_Ctp
properties	minOcc 0 maxOcc 1 content complex

facets	Kind pattern	Value [0-9]{4}-[0-9]{2}-[0-9]{2}	Annotation			
attributes	Name genauigkeit	Type derived by: xs:string	Use optional	Default	Fixed	Annotation documentation Bedeutung s. UngenauesDatum_Ctp
annotation	documentation Geburtsdatum der Person					
source	<pre><xs:element name="Geburtsdatum" type="GI4X-basis:UngenauesDatum_Ctp" minOccurs="0"> <xs:annotation> <xs:documentation>Geburtsdatum der Person</xs:documentation> </xs:annotation> </xs:element></pre>					

complexType UngenauesDatum_Ctp

diagram	<p>Dieser Datentyp erlaubt die Spezifikation eines Datums, bei dem eventuell der Tag oder Monat nicht exakt bekannt sind. Die Genauigkeit wird über das optionale Attribut 'genauigkeit' festgelegt: Fehlt das Attribut oder hat das Attribut den Wert 'Tag' handelt es sich um ein tagesgenaues Datum. Hat das Attribut den Wert 'Monat', ist das Datum monatsgenau, d.h. der Monat ist bekannt, der Tag ist nicht exakt bekannt. Hat das Attribut den Wert 'Jahr', ist nur das im Datum angegebene Jahr genau bekannt. Auch bei ungenauen Angaben muß der Wert sämtliche Bestandteile (Jahr, Monat, Tag) enthalten, damit die XML Schema Prüfung keinen Fehler produziert. Für monatsgenaue Datumsangaben sollte als Tag '01' verwendet werden, bei jahresgenauen Datumsangaben sollte als Monat-Tag Wert '01-01' angegeben werden.</p>					
namespace	GI4X:/xml-schema/GI4X-basis/2.0					
type	extension of GI4X-basis:Datum_Stp					
properties	base GI4X-basis:Datum_Stp final extension					
used by	element Person_Ctp/Geburtsdatum					
facets	Kind pattern	Value [0-9]{4}-[0-9]{2}-[0-9]{2}	Annotation			
attributes	Name	Type	Use	Default	Fixed	Annotation

	<p>genauigkeit derived by: optional xs:string</p> <p>documentation Bedeutung s. UngenauesDatum_Ctp</p>
annotation	<p>documentation</p> <p>Dieser Datentyp erlaubt die Spezifikation eines Datums, bei dem eventuell der Tag oder Monat nicht exakt bekannt sind. Die Genauigkeit wird über das optionale Attribut 'genauigkeit' festgelegt: Fehlt das Attribut oder hat das Attribut den Wert 'Tag' handelt es sich um ein tagesgenaues Datum. Hat das Attribut den Wert 'Monat', ist das Datum monatsgenau, d.h. der Monat ist bekannt, der Tag ist nicht exakt bekannt. Hat das Attribut den Wert 'Jahr', ist nur das im Datum angegebene Jahr genau bekannt. Auch bei ungenauen Angaben muß der Wert sämtliche Bestandteile (Jahr, Monat, Tag) enthalten, damit die XML Schema Prüfung keinen Fehler produziert. Für monatsgenaue Datumsangaben sollte als Tag '01' verwendet werden, bei jahresgenauen Datumsangaben sollte als Monat-Tag Wert '01-01' angegeben werden.</p> <p>appinfo <Kommentar/> <Beispiele><![CDATA[<Geburtsdatum>1969-12-13</Geburtsdatum> Tagesgenaue Angabe <Geburtsdatum genauigkeit="Tag">1969-12-13</Geburtsdatum> Tagesgenaue Angabe <Geburtsdatum genauigkeit="Monat">1969-12-01</Geburtsdatum> Monatsgenaue Angabe <Geburtsdatum genauigkeit="Jahr">1969-01-01</Geburtsdatum> Jahresgenaue Angabe]]></Beispiele></p>
source	<pre><xs:complexType name="UngenauesDatum_Ctp" final="extension" dd:category="Basiss"> <xs:annotation> <xs:documentation>Dieser Datentyp erlaubt die Spezifikation eines Datums, bei dem eventuell der Tag oder Monat nicht exakt bekannt sind. Die Genauigkeit wird über das optionale Attribut 'genauigkeit' festgelegt: Fehlt das Attribut oder hat das Attribut den Wert 'Tag' handelt es sich um ein tagesgenaues Datum. Hat das Attribut den Wert 'Monat', ist das Datum monatsgenau, d.h. der Monat ist bekannt, der Tag ist nicht exakt bekannt. Hat das Attribut den Wert 'Jahr', ist nur das im Datum angegebene Jahr genau bekannt. Auch bei ungenauen Angaben muß der Wert sämtliche Bestandteile (Jahr, Monat, Tag) enthalten, damit die XML Schema Prüfung keinen Fehler produziert. Für monatsgenaue Datumsangaben sollte als Tag '01' verwendet werden, bei jahresgenauen Datumsangaben sollte als Monat-Tag Wert '01-01' angegeben werden. </xs:documentation> <xs:appinfo> <Kommentar/> <Beispiele><![CDATA[<Geburtsdatum>1969-12-13</Geburtsdatum> Tagesgenaue Angabe <Geburtsdatum genauigkeit="Tag">1969-12-13</Geburtsdatum> Tagesgenaue Angabe <Geburtsdatum genauigkeit="Monat">1969-12-01</Geburtsdatum> Monatsgenaue Angabe <Geburtsdatum genauigkeit="Jahr">1969-01-01</Geburtsdatum> Jahresgenaue Angabe]]></Beispiele> </xs:appinfo> </xs:annotation> <xs:simpleContent> <xs:extension base="G4X-basis: Datum_Stp"> <xs:attribute name="genauigkeit" use="optional"> <xs:annotation> <xs:documentation>Bedeutung s. UngenauesDatum_Ctp</xs:documentation> </xs:annotation> <xs:simpleType> <xs:restriction base="xs:string"> <xs:enumeration value="Tag"/> <xs:enumeration value="Monat"/> <xs:enumeration value="Jahr"/> </xs:restriction> </xs:simpleType> </xs:extension> </xs:simpleContent> </xs:complexType></pre>

	<pre> </xs:restriction> </xs:simpleType> </xs:attribute> </xs:extension> </xs:simpleContent> </xs:complexType> </pre>
--	---

attribute UngenauesDatum_Ctp/@genauigkeit

type	restriction of xs:string												
properties	use optional												
facets	<table border="1"> <thead> <tr> <th>Kind</th> <th>Value</th> <th>Annotation</th> </tr> </thead> <tbody> <tr> <td>enumeration</td> <td>Tag</td> <td></td> </tr> <tr> <td>enumeration</td> <td>Monat</td> <td></td> </tr> <tr> <td>enumeration</td> <td>Jahr</td> <td></td> </tr> </tbody> </table>	Kind	Value	Annotation	enumeration	Tag		enumeration	Monat		enumeration	Jahr	
Kind	Value	Annotation											
enumeration	Tag												
enumeration	Monat												
enumeration	Jahr												
annotation	documentation Bedeutung s. UngenauesDatum_Ctp												
source	<pre> <xs:attribute name="genauigkeit" use="optional"> <xs:annotation> <xs:documentation>Bedeutung s. UngenauesDatum_Ctp</xs:documentation> </xs:annotation> <xs:simpleType> <xs:restriction base="xs:string"> <xs:enumeration value="Tag"/> <xs:enumeration value="Monat"/> <xs:enumeration value="Jahr"/> </xs:restriction> </xs:simpleType> </xs:attribute> </pre>												

complexType Wurzel_Ctp

diagram													
namespace	GI4X:/xml-schema/GI4X-basis/2.0												
properties	final restriction												
attributes	<table border="1"> <thead> <tr> <th>Name</th> <th>Type</th> <th>Use</th> <th>Default</th> <th>Fixed</th> <th>Annotation</th> </tr> </thead> <tbody> <tr> <td>logische_version</td> <td>GI4X-basis:Logische_Version_Stp</td> <td>required</td> <td></td> <td></td> <td></td> </tr> </tbody> </table>	Name	Type	Use	Default	Fixed	Annotation	logische_version	GI4X-basis:Logische_Version_Stp	required			
Name	Type	Use	Default	Fixed	Annotation								
logische_version	GI4X-basis:Logische_Version_Stp	required											
annotation	documentation Von diesem Typ sollten alle verfahrensspezifischen Nutzdaten abgeleitet sein. appinfo <Kommentar>Sollte es nicht möglich sein, verfahrensspezifische Nutzdaten von diesem Typ abzuleiten, dann muss das Attribut logische_version verwendet werden!</Kommentar>												
source	<pre> <xs:complexType name="Wurzel_Ctp" final="restriction" dd:category="Richtlinie / Metadaten"> </pre>												

	<pre> <xs: annotation> <xs: documentation>Von diesem Typ sollten alle verfahrensspezifischen Nutzdaten abgeleitet sein.</xs: documentation> <xs: appinfo> <Kommentar>Sollte es nicht möglich sein, verfahrensspezifische Nutzdaten von diesem Typ abzuleiten, dann muss das Attribut logische_version verwendet werden!</Kommentar> </xs: appinfo> </xs: annotation> <xs: attribute name="logische_version" type="GI4X-basis:Logische_Version_Stp" use="required"/> </xs: complexType> </pre>
--	---

attribute Wurzel_Ctp/@logische_version

type	GI4X-basis:Logische_Version_Stp						
properties	use required						
facets	<table border="1"> <thead> <tr> <th>Kind</th> <th>Value</th> <th>Annotation</th> </tr> </thead> <tbody> <tr> <td>pattern</td> <td>[1-9][0-9]{0,2}\.(0 [1-9][0-9]{0,2})\.(0 [1-9][0-9]{0,2})</td> <td></td> </tr> </tbody> </table>	Kind	Value	Annotation	pattern	[1-9][0-9]{0,2}\.(0 [1-9][0-9]{0,2})\.(0 [1-9][0-9]{0,2})	
Kind	Value	Annotation					
pattern	[1-9][0-9]{0,2}\.(0 [1-9][0-9]{0,2})\.(0 [1-9][0-9]{0,2})						
source	<pre> <xs: attribute name="logische_version" type="GI4X-basis:Logische_Version_Stp" use="required"/> </pre>						

simpleType BNR_Stp

namespace	GI4X:/xml-schema/GI4X-basis/2.0												
type	restriction of xs:string												
properties	base xs:string												
facets	<table border="1"> <thead> <tr> <th>Kind</th> <th>Value</th> <th>Annotation</th> </tr> </thead> <tbody> <tr> <td>minLength</td> <td>8</td> <td></td> </tr> <tr> <td>maxLength</td> <td>8</td> <td></td> </tr> <tr> <td>pattern</td> <td>[0-9]+</td> <td></td> </tr> </tbody> </table>	Kind	Value	Annotation	minLength	8		maxLength	8		pattern	[0-9]+	
Kind	Value	Annotation											
minLength	8												
maxLength	8												
pattern	[0-9]+												
annotation	<p>documentation</p> <p>Betriebsnummer der Bundesagentur für Arbeit (BA)</p>												
source	<pre> <xs: simpleType name="BNR_Stp" dd:category="Identifikationsmerkmale / GKV"> <xs: annotation> <xs: documentation>Betriebsnummer der Bundesagentur für Arbeit (BA)</xs: documentation> </xs: annotation> <xs: restriction base="xs:string"> <xs: minLength value="8"/> <xs: maxLength value="8"/> <xs: pattern value="[0-9]+"> </xs: restriction> </xs: simpleType> </pre>												

simpleType BSNR_Stp

namespace	GI4X:/xml-schema/GI4X-basis/2.0												
type	restriction of xs:string												
properties	base xs:string												
used by	simpleType BSNR_Stp												
facets	<table border="1"> <thead> <tr> <th>Kind</th> <th>Value</th> <th>Annotation</th> </tr> </thead> <tbody> <tr> <td>minLength</td> <td>9</td> <td></td> </tr> <tr> <td>maxLength</td> <td>9</td> <td></td> </tr> <tr> <td>pattern</td> <td>[0-9]+</td> <td></td> </tr> </tbody> </table>	Kind	Value	Annotation	minLength	9		maxLength	9		pattern	[0-9]+	
Kind	Value	Annotation											
minLength	9												
maxLength	9												
pattern	[0-9]+												
annotation	<p>documentation</p> <p>Die Betriebsstättennummer, kurz BSNR, ist eine neunstellige Nummer, die im Rahmen der vertragsärztlichen Versorgung den Ort der Leistungserbringung (Betriebsstätte) eindeutig identifiziert. Sie wird aus der alten siebenstelligen Abrechnungsnummer erzeugt, indem als 8. und 9. Stelle die "00" ergänzt wird. Weitere Orte der Leistungserbringung werden mit einer Nebenbetriebsstättennummer (NBSNR) belegt.</p>												
source	<pre><xs:simpleType name="BSNR_Stp" dd:category="Identifikationsmerkmale / GKV"> <xs:annotation> <xs:documentation>Die Betriebsstättennummer, kurz BSNR, ist eine neunstellige Nummer, die im Rahmen der vertragsärztlichen Versorgung den Ort der Leistungserbringung (Betriebsstätte) eindeutig identifiziert. Sie wird aus der alten siebenstelligen Abrechnungsnummer erzeugt, indem als 8. und 9. Stelle die "00" ergänzt wird. Weitere Orte der Leistungserbringung werden mit einer Nebenbetriebsstättennummer (NBSNR) belegt. </xs:documentation> </xs:annotation> <xs:restriction base="xs:string"> <xs:minLength value="9"/> <xs:maxLength value="9"/> <xs:pattern value="[0-9]+"/> </xs:restriction> </xs:simpleType></pre>												

simpleType CentBetrag_Stp

namespace	GI4X:/xml-schema/GI4X-basis/2.0
type	xs:int
properties	base xs:int
annotation	<p>documentation</p> <p>Einschränkung?</p> <p>Der Centbetrag ist ein in Cent bemessener Wert. Dieser Datentyp lässt sich z.Bsp. für Punktwerte verwenden: Ein Punktwert ist für die Vergütungshöhe einer ärztlichen Leistung entscheidend: Indem dieser Wert mit den Punkten einer ärztlichen Leistung des Einheitlichen Bewertungsmaßstabes multipliziert wird, errechnet sich die tatsächliche Vergütungshöhe dieser Leistung. Die Werte können negativ sein.</p>
source	<pre><xs:simpleType name="CentBetrag_Stp" dd:category="Finanzen / Abrechnung"> <xs:annotation> <xs:documentation>Einschränkung? Der Centbetrag ist ein in Cent bemessener Wert. </xs:documentation> </xs:simpleType></pre>

	<p>Dieser Datentyp lässt sich z. Bsp. für Punktwerte verwenden: Ein Punktwert ist für die Vergütungshöhe einer ärztlichen Leistung entscheidend: Indem dieser Wert mit den Punkten einer ärztlichen Leistung des Einheitlichen Bewertungsmaßstabes multipliziert wird, errechnet sich die tatsächliche Vergütungshöhe dieser Leistung. Die Werte können negativ sein. <code></xs:documentation></code> <code></xs:annotation></code> <code><xs:restriction base="xs:int" /></code> <code></xs:simpleType></code></p>
--	---

simpleType Datum_Stp

namespace	GI4X:/xml-schema/GI4X-basis/2.0						
type	restriction of xs:date						
properties	base xs:date						
used by	complexType UngenauesDatum_Ctp						
facets	<table border="1"> <thead> <tr> <th>Kind</th> <th>Value</th> <th>Annotation</th> </tr> </thead> <tbody> <tr> <td>pattern</td> <td>[0-9]{4}-[0-9]{2}-[0-9]{2}</td> <td></td> </tr> </tbody> </table>	Kind	Value	Annotation	pattern	[0-9]{4}-[0-9]{2}-[0-9]{2}	
Kind	Value	Annotation					
pattern	[0-9]{4}-[0-9]{2}-[0-9]{2}						
annotation	<p>documentation Dieser Datentyp dient der Repräsentation eines tagesgenauen Datums und umfasst den Tag der um 00:00 Uhr Mitteleuropäische Zeit (MEZ/CET) bzw. Mitteleuropäischer Sommerzeit (MESZ/CEST) beginnt und bis 00:00 (exklusive) des nächsten Tages dauert. Die MEZ ist als UTC+1, die MESZ als UTC+2 definiert (koordinierte Weltzeit +1 Stunde, bzw +2 Stunden). Das zu verwendende Datumsformat ist eine Einschränkung von xs:date (ISO 8601) auf JJJJ-MM-TT, da die Zeitzone durch diese Definition vorgegeben ist.</p> <p>appinfo <Kommentar> Wenn dieser Datentyp für Stichtage verwendet wird, so ist das angegebene Datum als inklusive anzusehen.</Kommentar> <Beispiele>2008-04-29</Beispiele></p>						
source	<pre> <xs:simpleType name="Datum_Stp" dd:category="Basis"> <xs:annotation> <xs:documentation>Dieser Datentyp dient der Repräsentation eines tagesgenauen Datums und umfasst den Tag der um 00:00 Uhr Mitteleuropäische Zeit (MEZ/CET) bzw. Mitteleuropäischer Sommerzeit (MESZ/CEST) beginnt und bis 00:00 (exklusive) des nächsten Tages dauert. Die MEZ ist als UTC+1, die MESZ als UTC+2 definiert (koordinierte Weltzeit +1 Stunde, bzw +2 Stunden). Das zu verwendende Datumsformat ist eine Einschränkung von xs:date (ISO 8601) auf JJJJ-MM-TT, da die Zeitzone durch diese Definition vorgegeben ist. </xs:documentation> <xs:appinfo> <Kommentar> Wenn dieser Datentyp für Stichtage verwendet wird, so ist das angegebene Datum als inklusive anzusehen.</Kommentar> <Beispiel e>2008-04-29</Beispiel e> </xs:appinfo> </xs:annotation> <xs:restriction base="xs:date"> <xs:pattern value="[0-9]{4}-[0-9]{2}-[0-9]{2}" /> </xs:restriction> </xs:simpleType> </pre>						

simpleType Datum_Uhrzeit_Stp

namespace	GI4X:/xml-schema/GI4X-basis/2.0						
type	restriction of xs:dateTime						
properties	base xs:dateTime						
facets	<table border="1"> <thead> <tr> <th>Kind</th> <th>Value</th> <th>Annotation</th> </tr> </thead> <tbody> <tr> <td>pattern</td> <td>[0-9]{4}-[0-9]{2}-[0-9]{2}T[0-9]{2}:[0-9]{2}</td> <td></td> </tr> </tbody> </table>	Kind	Value	Annotation	pattern	[0-9]{4}-[0-9]{2}-[0-9]{2}T[0-9]{2}:[0-9]{2}	
Kind	Value	Annotation					
pattern	[0-9]{4}-[0-9]{2}-[0-9]{2}T[0-9]{2}:[0-9]{2}						
annotation	<p>documentation</p> <p>Dieser Datentyp dient der Repräsentation eines minutengenauen Zeitpunkts. Die verwendete Zeitzone ist je nach Datum und Uhrzeit entweder die Mitteleuropäische Zeit (MEZ/CET) bzw. Mitteleuropäische Sommerzeit (MESZ/CEST). Die MEZ ist als UTC+1 Stunde, die MESZ als UTC+2 Stunden definiert (koordinierte Weltzeit +1 Stunde, bzw +2 Stunden). Dieser Datentyp verzichtet bewußt auf eine Unterscheidung des am Tag der Winter- auf Sommerzeitumstellung doppelt auftretenden Zeitraums von 2:00 bis 3:00 Uhr. Das verwendete Format ist eine Einschränkung von xs:dateTime (ISO 8601) auf JJJJ-MM-TT'T'HH:mm</p> <p>appinfo</p> <p><Kommentar/></p> <p><Beispiele>2008-04-29T10:35</Beispiele></p>						
source	<pre><xs:simpleType name="Datum_Uhrzeit_Stp" dd:category="Basis"> <xs:annotation> <xs:documentation>Dieser Datentyp dient der Repräsentation eines minutengenauen Zeitpunkt. Die verwendete Zeitzone ist je nach Datum und Uhrzeit entweder die Mitteleuropäische Zeit (MEZ/CET) bzw. Mitteleuropäische Sommerzeit (MESZ/CEST). Die MEZ ist als UTC+1 Stunde, die MESZ als UTC+2 Stunden definiert (koordinierte Weltzeit +1 Stunde, bzw +2 Stunden). Dieser Datentyp verzichtet bewußt auf eine Unterscheidung des am Tag der Winter- auf Sommerzeitumstellung doppelt auftretenden Zeitraums von 2:00 bis 3:00 Uhr. Das verwendete Format ist eine Einschränkung von xs:dateTime (ISO 8601) auf JJJJ-MM-TT'T'HH:mm</xs:documentation> <xs:appinfo> <Kommentar/> <Beispiele>2008-04-29T10:35</Beispiele> </xs:appinfo> </xs:annotation> <xs:restriction base="xs:dateTime"> <xs:pattern value="[0-9]{4}-[0-9]{2}-[0-9]{2}T[0-9]{2}:[0-9]{2}"/> </xs:restriction> </xs:simpleType></pre>						

simpleType EmailAdresse_Stp

namespace	GI4X:/xml-schema/GI4X-basis/2.0									
type	restriction of xs:string									
properties	base xs:string									
used by	simpleType Email_Stp									
facets	<table border="1"> <thead> <tr> <th>Kind</th> <th>Value</th> <th>Annotation</th> </tr> </thead> <tbody> <tr> <td>minLength</td> <td>1</td> <td></td> </tr> <tr> <td>maxLength</td> <td>320</td> <td></td> </tr> </tbody> </table>	Kind	Value	Annotation	minLength	1		maxLength	320	
Kind	Value	Annotation								
minLength	1									
maxLength	320									
annotation	documentation									

	Email-Adresse nach RFC 2821 (max. Länge = 320). Auf eine formale Patternprüfung wird hier aus Komplexitätsgründen verzichtet.
source	<pre> <xs:simpleType name="EmailAdresse_Stp" dd:category="Kommunikation"> <xs:annotation> <xs:documentation>Email-Adresse nach RFC 2821 (max. Länge = 320). Auf eine formale Patternprüfung wird hier aus Komplexitätsgründen verzihtet. </xs:documentation> </xs:annotation> <xs:restriction base="xs:string"> <xs:minLength value="1"/> <xs:maxLength value="320"/> </xs:restriction> </xs:simpleType> </pre>

simpleType EuroBetrag_Stp

namespace	GI4X:/xml-schema/GI4X-basis/2.0									
type	restriction of xs:decimal									
properties	base xs:decimal									
facets	<table border="1"> <thead> <tr> <th>Kind</th> <th>Value</th> <th>Annotation</th> </tr> </thead> <tbody> <tr> <td>fractionDigits</td> <td>2</td> <td></td> </tr> <tr> <td>pattern</td> <td>[+\-]?[0-9]+\.[0-9][0-9]</td> <td></td> </tr> </tbody> </table>	Kind	Value	Annotation	fractionDigits	2		pattern	[+\-]?[0-9]+\.[0-9][0-9]	
Kind	Value	Annotation								
fractionDigits	2									
pattern	[+\-]?[0-9]+\.[0-9][0-9]									
annotation	<p>documentation Geldbetrag in Euro, mit genau 2 Nachkommastellen</p> <p>appinfo <Beispiele>0.23, 123.45,+5.00,-43.22 oder 17.00, NICHT aber 18.4, 19 oder 17,95</Beispiele></p>									
source	<pre> <xs:simpleType name="EuroBetrag_Stp" dd:category="Finanzen / Abrechnung"> <xs:annotation> <xs:documentation>Geldbetrag in Euro, mit genau 2 Nachkommastellen</xs:documentation> <xs:appinfo> <Beispiel e>0.23, 123.45,+5.00,-43.22 oder 17.00, NICHT aber 18.4, 19 oder 17,95</Beispiel e> </xs:appinfo> </xs:annotation> <xs:restriction base="xs:decimal"> <xs:fractionDigits value="2"/> <xs:pattern value="[+\-]?[0-9]+\.[0-9][0-9]"/> </xs:restriction> </xs:simpleType> </pre>									

simpleType Hausnummer_Stp

namespace	GI4X:/xml-schema/GI4X-basis/2.0			
type	restriction of GI4X-basis:ISO88591_Stp			
properties	base GI4X-basis:ISO88591_Stp			
used by	element Anschrift Ctp/Hausnummer			
facets	<table border="1"> <thead> <tr> <th>Kind</th> <th>Value</th> <th>Annotation</th> </tr> </thead> <tbody> </tbody> </table>	Kind	Value	Annotation
Kind	Value	Annotation		

	minLength 1 maxLength 15 pattern [#x0020;-ÿ]+
annotation	documentation Eine Hausnummer dient der genauen Lokalisierung eines Grundstuecks, Gebaeudes oder Gebaedeteils (Eingang) in einer Strasse. Hausnummern koennen entsprechend der ueblichen Praxis in vielen Gemeinden mit ergaenzenden Angaben zur weiteren Unterteilung versehen werden, etwa "12a" oder "17 1/3". Da manche Gebaeude oder Organisationen sich als Einheit ueber mehrere Hausnummern erstrecken, koennen auch Hausnummernbereiche angegeben werden, etwa "12a - 12e" oder "1 - 3". appinfo <Kommentar> Die Schreibweise für ergänzende Angaben und für Hausnummernbereiche ist in Deutschland uneinheitlich und kann daher nicht genau vorgegeben werden. Eine Aufteilung in numerische und diverse weitere Zusätze wurde bewusst nicht vorgenommen. </Kommentar> <Beispiele>212 12a 17 1/3 12a - 12e 12 a-e 1 - 3</Beispiele>
source	<xs:simpleType name="Hausnummer_Stp" dd:category="Anschri ft / Adresse"> <xs:annotation> <xs:documentation>Eine Hausnummer dient der genauen Lokalisierung eines Grundstuecks, Gebaeudes oder Gebaedeteils (Eingang) in einer Strasse. Hausnummern koennen entsprechend der ueblichen Praxis in vielen Gemeinden mit ergaenzenden Angaben zur weiteren Unterteilung versehen werden, etwa "12a" oder "17 1/3". Da manche Gebaeude oder Organisationen sich als Einheit ueber mehrere Hausnummern erstrecken, koennen auch Hausnummernbereiche angegeben werden, etwa "12a - 12e" oder "1 - 3". </xs:documentation> <xs:appinfo> <Kommentar> Die Schreibweise für ergänzende Angaben und für Hausnummernbereiche ist in Deutschland uneinheitlich und kann daher nicht genau vorgegeben werden. Eine Aufteilung in numerische und diverse weitere Zusätze wurde bewusst nicht vorgenommen. </Kommentar> <Beispiel e>212 12a 17 1/3 12a - 12e 12 a-e 1 - 3</Beispiel e> </xs:appinfo> </xs:annotation> <xs:restriction base="GI4X-basis: IS088591_Stp"> <xs:minLength value="1"/> <xs:maxLength value="15"/> </xs:restriction> </xs:simpleType>

simpleType IK_Stp

namespace	GI4X/xml-schema/GI4X-basis/2.0
type	restriction of xs:string
properties	base xs:string
used by	simpleType IK_Stp
facets	Kind Value Annotation minLength 9

	maxLength 9 pattern [0-9]+
annotation	documentation <p>Das Institutionskennzeichen (IK) ist ein eindeutiges Merkmal zur Abrechnung mit den Trägern der Sozialversicherung. Alle Vertragspartner, die für die Sozialversicherungsträger Leistungen erbringen, erhalten ein Institutionskennzeichen für die maschinelle Erledigung des Abrechnungsverfahrens und den Zahlungsverkehr. Das IK besteht aus 9 Ziffern.</p>
source	<pre><xs:simpleType name="IK_Stp" dd:category="Identifikationsmerkmale / GKV"> <xs:annotation> <xs:documentation> Das Institutionskennzeichen (IK) ist ein eindeutiges Merkmal zur Abrechnung mit den Trägern der Sozialversicherung. Alle Vertragspartner, die für die Sozialversicherungsträger Leistungen erbringen, erhalten ein Institutionskennzeichen für die maschinelle Erledigung des Abrechnungsverfahrens und den Zahlungsverkehr. Das IK besteht aus 9 Ziffern. </xs:documentation> </xs:annotation> <xs:restriction base="xs:string"> <xs:minLength value="9"/> <xs:maxLength value="9"/> <xs:pattern value="[0-9]+"/> </xs:restriction> </xs:simpleType></pre>

simpleType ISO88591_Stp

namespace	GI4X:/xml-schema/GI4X-basis/2.0									
type	restriction of xs:string									
properties	base xs:string									
used by	simpleTypes Abw-Anschrift_Stp Anrede_Stp Anschriftenzusatz_Stp Hausnummer_Stp Nachname_Stp Namenstitel_Stp Namensvorsatz_Stp Namenszusatz_Stp Ort_Stp Ort_Stp Postleitzahl_Stp Rufnummer_Stp Strasse_Hausnummer_Stp Strasse_Stp Vorname_Stp									
facets	<table border="0"> <tr> <td>Kind</td> <td>Value</td> <td>Annotation</td> </tr> <tr> <td>minLength</td> <td>1</td> <td></td> </tr> <tr> <td>pattern</td> <td>[&#x0020;-&#x00FF;]+</td> <td></td> </tr> </table>	Kind	Value	Annotation	minLength	1		pattern	[-ÿ]+	
Kind	Value	Annotation								
minLength	1									
pattern	[-ÿ]+									
annotation	documentation <p>Eine 'ISO88591_Stp' Zeichenkette enthält nur Zeichen aus dem Zeichensatz ISO-8859-1 ohne Zeilenumbrüche (CR/LF) und Tab. Dieser Datentyp sollte als Basis für einfache Zeichenkettenfelder verwendet werden, bei denen Zeilenumbrüche/Tabs in den Daten nicht erwünscht sind.</p> <p>appinfo</p>									
source	<pre><xs:simpleType name="ISO88591_Stp" dd:category="Basiss"> <xs:annotation> <xs:documentation>Eine 'ISO88591_Stp' Zeichenkette enthält nur Zeichen aus dem Zeichensatz ISO-8859-1 ohne Zeilenumbrüche (CR/LF) und Tab. Dieser Datentyp sollte als Basis für einfache Zeichenkettenfelder verwendet werden, bei denen</pre>									

	<p>Zeilenumbrüche/Tabs in den Daten nicht erwünscht sind.</p> <pre> </xs:documentation> <xs:appinfo> </xs:appinfo> </xs:annotation> <xs:restriction base="xs:string"> <xs:minLength value="1"/> <xs:pattern value="[\n\r\t&#x0020;-&#x00FF;]+"/> </xs:restriction> </xs:simpleType> </pre>
--	---

simpleType ISO88591_Text_Stp

namespace	GI4X:/xml-schema/GI4X-basis/2.0									
type	restriction of xs:string									
properties	base xs:string									
facets	<table border="1"> <thead> <tr> <th>Kind</th> <th>Value</th> <th>Annotation</th> </tr> </thead> <tbody> <tr> <td>minLength</td> <td>1</td> <td></td> </tr> <tr> <td>pattern</td> <td>[\n\r\t&#x0020;-&#x00FF;]+</td> <td></td> </tr> </tbody> </table>	Kind	Value	Annotation	minLength	1		pattern	[\n\r\t -ÿ]+	
Kind	Value	Annotation								
minLength	1									
pattern	[\n\r\t -ÿ]+									
annotation	<p>documentation</p> <p>Eine 'ISO88591_Text_Stp' Zeichenkette enthält Zeichen aus dem Zeichensatz ISO-8859-1. Dieser Datentyp kann Zeilenumbrüche/Tabs enthalten und sollte als Basis für mehrzeilige Texte verwendet werden.</p> <p>appinfo</p>									
source	<pre> <xs:simpleType name="ISO88591_Text_Stp" dd:category="Basis"> <xs:annotation> <xs:documentation> Eine 'ISO88591_Text_Stp' Zeichenkette enthält Zeichen aus dem Zeichensatz ISO-8859-1. Dieser Datentyp kann Zeilenumbrüche/Tabs enthalten und sollte als Basis für mehrzeilige Texte verwendet werden. </xs:documentation> </xs:annotation> <xs:restriction base="xs:string"> <xs:minLength value="1"/> <xs:pattern value="[\n\r\t&#x0020;-&#x00FF;]+"/> </xs:restriction> </xs:simpleType> </pre>									

simpleType KVNR_Allgemein_Stp

namespace	GI4X:/xml-schema/GI4X-basis/2.0
type	restriction of xs:string
properties	base xs:string

facets	<table border="1"> <thead> <tr> <th data-bbox="284 282 395 309">Kind</th> <th data-bbox="395 282 663 309">Value</th> <th data-bbox="663 282 1415 309">Annotation</th> </tr> </thead> <tbody> <tr> <td data-bbox="284 309 395 336">minLength</td> <td data-bbox="395 309 663 336">20</td> <td data-bbox="663 309 1415 336"></td> </tr> <tr> <td data-bbox="284 336 395 362">maxLength</td> <td data-bbox="395 336 663 362">30</td> <td data-bbox="663 336 1415 362"></td> </tr> <tr> <td data-bbox="284 362 395 421">pattern</td> <td colspan="2" data-bbox="395 362 1415 421">[A-Z][0-9]{19}([0-9]{10})?</td> </tr> </tbody> </table>	Kind	Value	Annotation	minLength	20		maxLength	30		pattern	[A-Z][0-9]{19}([0-9]{10})?	
Kind	Value	Annotation											
minLength	20												
maxLength	30												
pattern	[A-Z][0-9]{19}([0-9]{10})?												
annotation	<p>documentation</p> <p>Krankenversicherthenummer (im allgemeinen Format). Die Krankenversicherthenummer besteht aus einem alphanumerischen und einem numerischen Baustein. Der unveränderbare Teil – dabei handelt es sich um die eigentliche Krankenversicherthenummer, die ausschlaggebend für alle Verfahren ist – ist einer bestimmten Person, dem Hauptversicherten oder einem mitversicherten Familienangehörigen, zugeordnet und begleitet ihn ein Leben lang. Dieser Teil der neuen Krankenversicherthenummer hat 10 Stellen. Der veränderbare Teil enthält Informationen über die Krankenkasse. Die 9-stellige Nummer ist das so genannte Institutionskennzeichen der Krankenkasse. Der Bezug eines Angehörigen zum Mitglied wird über einen weiteren Nummern-Teil hergestellt. Dieser ist 10 Stellen lang. In den Regelverfahren der Krankenkassen (Datenaustausch mit den Leistungserbringern, Gesundheitskarte etc.) werden der unveränderbare Teil, der veränderbare Teil und der Bezug eines Familienangehörigen jeweils in getrennten Datenfeldern verwendet. Für den Fall, dass für den unveränderbaren Teil (Stelle 1 - 10) und die Kassenzugehörigkeit (Stelle 11 - 19) in bestimmten Anwendungen nur ein Datenfeld zur Verfügung steht, ist eine zusätzliche Prüfziffer (Stelle 20) erforderlich. Werden alle drei Bestandteile der Krankenversicherthenummer in einem Datenfeld verwendet, kommt ebenfalls eine zusätzliche Prüfziffer (Stelle 30) zum Einsatz. Die neue Krankenversicherthenummer hat somit 20 Stellen für Hauptversicherte und 30 Stellen für Familienangehörige</p> <p>appinfo</p> <p><Kommentar>In Fachverfahren wird wahrscheinlich eine Trennung in die verschiedenen Komponenten erfolgen.</Kommentar></p>												
source	<pre><xs:simpleType name="KVNR_AI l gemei n_Stp" dd:category="I denti fi kati onsmerkmal e / GKV"> <xs:annotation> <xs:documentation>Krankenversicherthenummer (im allgemeinen Format). Die Krankenversicherthenummer besteht aus einem alphanumerischen und einem numerischen Baustein. Der unveränderbare Teil – dabei handelt es sich um die eigentliche Krankenversicherthenummer, die ausschlaggebend für alle Verfahren ist – ist einer bestimmten Person, dem Hauptversicherten oder einem mitversicherten Familienangehörigen, zugeordnet und begleitet ihn ein Leben lang. Dieser Teil der neuen Krankenversicherthenummer hat 10 Stellen. Der veränderbare Teil enthält Informationen über die Krankenkasse. Die 9-stellige Nummer ist das so genannte Institutionskennzeichen der Krankenkasse. Der Bezug eines Angehörigen zum Mitglied wird über einen weiteren Nummern-Teil hergestellt. Dieser ist 10 Stellen lang. In den Regelverfahren der Krankenkassen (Datenaustausch mit den Leistungserbringern, Gesundheitskarte etc.) werden der unveränderbare Teil, der veränderbare Teil und der Bezug eines Familienangehörigen jeweils in getrennten Datenfeldern verwendet. Für den Fall, dass für den unveränderbaren Teil (Stelle 1 - 10) und die Kassenzugehörigkeit (Stelle 11 - 19) in bestimmten Anwendungen nur ein Datenfeld zur Verfügung steht, ist eine zusätzliche Prüfziffer (Stelle 20) erforderlich. Werden alle drei Bestandteile der Krankenversicherthenummer in einem Datenfeld verwendet, kommt ebenfalls eine zusätzliche Prüfziffer (Stelle 30) zum Einsatz. Die neue Krankenversicherthenummer hat somit 20 Stellen für Hauptversicherte und 30 Stellen für Familienangehörige </xs:documentation> <xs:appinfo> <Kommentar>In Fachverfahren wird wahrscheinlich eine Trennung in die verschiedenen Komponenten erfolgen.</Kommentar> </xs:appinfo> </xs:annotation></pre>												

	<pre> <xs:restriction base="xs:string"> <xs:minLength value="20"/> <xs:maxLength value="30"/> <xs:pattern value="[A-Z][0-9]{19}([0-9]{10})?" /> </xs:restriction> </xs:simpleType> </pre>
--	---

simpleType KVNR_Alt_Stp

namespace	GI4X:/xml-schema/GI4X-basis/2.0												
type	restriction of xs:string												
properties	base xs:string												
facets	<table border="1"> <thead> <tr> <th>Kind</th> <th>Value</th> <th>Annotation</th> </tr> </thead> <tbody> <tr> <td>minLength</td> <td>9</td> <td></td> </tr> <tr> <td>maxLength</td> <td>12</td> <td></td> </tr> <tr> <td>pattern</td> <td>[0-9A-Z][0-9]+</td> <td></td> </tr> </tbody> </table>	Kind	Value	Annotation	minLength	9		maxLength	12		pattern	[0-9A-Z][0-9]+	
Kind	Value	Annotation											
minLength	9												
maxLength	12												
pattern	[0-9A-Z][0-9]+												
annotation	<p>documentation Datentyp für die Repräsentation alter (variabel langer) Krankenversicherenummern.</p> <p>appinfo <Kommentar> </Kommentar></p>												
source	<pre> <xs:simpleType name="KVNR_Alt_Stp" dd:category="Identifikationsmerkmale / GKV"> <xs:annotation> <xs:documentation>Datentyp für die Repräsentation alter (variabel langer) Krankenversicherenummern. </xs:documentation> <xs:appinfo> <Kommentar> </Kommentar> </xs:appinfo> </xs:annotation> <xs:restriction base="xs:string"> <xs:minLength value="9"/> <xs:maxLength value="12"/> <xs:pattern value="[0-9A-Z][0-9]+" /> </xs:restriction> </xs:simpleType> </pre>												

simpleType KVNR_Stp

namespace	GI4X:/xml-schema/GI4X-basis/2.0												
type	restriction of xs:string												
properties	base xs:string												
facets	<table border="1"> <thead> <tr> <th>Kind</th> <th>Value</th> <th>Annotation</th> </tr> </thead> <tbody> <tr> <td>minLength</td> <td>10</td> <td></td> </tr> <tr> <td>maxLength</td> <td>10</td> <td></td> </tr> <tr> <td>pattern</td> <td>[0-9A-Z][0-9]+</td> <td></td> </tr> </tbody> </table>	Kind	Value	Annotation	minLength	10		maxLength	10		pattern	[0-9A-Z][0-9]+	
Kind	Value	Annotation											
minLength	10												
maxLength	10												
pattern	[0-9A-Z][0-9]+												

annotation	<p>documentation Datentyp für die Repräsentation des unveränderlichen (genau 10 stelligen) Teils der neuen Krankenversicherturnummer.</p> <p>appinfo <Kommentar> </Kommentar></p>
source	<pre><xs:simpleType name="KVNR_Stp" dd:category="Identifikationsmerkmale / GKV"> <xs:annotation> <xs:documentation>Datentyp für die Repräsentation des unveränderlichen (genau 10 stelligen) Teils der neuen Krankenversicherturnummer. </xs:documentation> </xs:annotation> <xs:appinfo> <Kommentar> </Kommentar> </xs:appinfo> </xs:annotation> <xs:restriction base="xs:string"> <xs:minLength value="10"/> <xs:maxLength value="10"/> <xs:pattern value="[0-9A-Z][0-9] +"/> </xs:restriction> </xs:simpleType></pre>

simpleType Laenderkennzeichen_Stp

namespace	GI4X:/xml-schema/GI4X-basis/2.0												
type	restriction of xs:string												
properties	base xs:string												
used by	<p>element Anschrift_Ctp/Land</p> <p>simpleType LKZ_Stp</p>												
facets	<table border="1"> <thead> <tr> <th>Kind</th> <th>Value</th> <th>Annotation</th> </tr> </thead> <tbody> <tr> <td>minLength</td> <td>1</td> <td></td> </tr> <tr> <td>maxLength</td> <td>3</td> <td></td> </tr> <tr> <td>pattern</td> <td>[A-Z]+</td> <td></td> </tr> </tbody> </table>	Kind	Value	Annotation	minLength	1		maxLength	3		pattern	[A-Z]+	
Kind	Value	Annotation											
minLength	1												
maxLength	3												
pattern	[A-Z]+												
annotation	<p>documentation Länderkennzeichen nach Anlage 8 DEÜV</p>												
source	<pre><xs:simpleType name="Laenderkennzeichen_Stp" dd:category="Verschiedenes"> <xs:annotation> <xs:documentation>Länderkennzeichen nach Anlage 8 DEÜV</xs:documentation> </xs:annotation> <xs:restriction base="xs:string"> <xs:minLength value="1"/> <xs:maxLength value="3"/> <xs:pattern value="[A-Z] +"/> </xs:restriction> </xs:simpleType></pre>												

simpleType LANR_Stp

namespace	GI4X:/xml-schema/GI4X-basis/2.0
-----------	---------------------------------

type	restriction of xs:string												
properties	base xs:string												
used by	simpleType LANR_Stp												
facets	<table border="1"> <thead> <tr> <th>Kind</th> <th>Value</th> <th>Annotation</th> </tr> </thead> <tbody> <tr> <td>minLength</td> <td>9</td> <td></td> </tr> <tr> <td>maxLength</td> <td>9</td> <td></td> </tr> <tr> <td>pattern</td> <td>[0-9]+</td> <td></td> </tr> </tbody> </table>	Kind	Value	Annotation	minLength	9		maxLength	9		pattern	[0-9]+	
Kind	Value	Annotation											
minLength	9												
maxLength	9												
pattern	[0-9]+												
annotation	<p>documentation</p> <p>Die lebenslange Arztnummer, kurz LANR, ist eine neunstellige Nummer, die die zuständige Kassenärztliche Vereinigung bundesweit an jeden Arzt vergibt, der an der vertragsärztlichen Versorgung teilnimmt. Sie ist durch das Vertragsarztrechtsänderungsgesetz (VÄndG) zusammen mit der Betriebsstättennummer (BSNR) für jede kassenärztliche Praxis gesetzlich in der BRD vorgeschrieben und durch die Flexibilisierung der vertragsärztlichen Tätigkeit notwendig geworden.</p> <p>LANR und BSNR sind seit dem 1. Juli 2008 gültig und ersetzen gemeinsam die alten KV-Abrechnungsnummern.</p> <p>appinfo</p> <p><Kommentar></p> <p style="text-align: right;">Werte dieses Typs sollten in Fachverfahren über eine geeignete</p> <p>Schlüsselprüfung validiert werden.</p> <p style="text-align: right;"></Kommentar></p>												
source	<pre><xs:simpleType name="LANR_Stp" dd:category="Identifikationsmerkmale / GKV"> <xs:annotation> <xs:documentation>Die lebenslange Arztnummer, kurz LANR, ist eine neunstellige Nummer, die die zuständige Kassenärztliche Vereinigung bundesweit an jeden Arzt vergibt, der an der vertragsärztlichen Versorgung teilnimmt. Sie ist durch das Vertragsarztrechtsänderungsgesetz (VÄndG) zusammen mit der Betriebsstättennummer (BSNR) für jede kassenärztliche Praxis gesetzlich in der BRD vorgeschrieben und durch die Flexibilisierung der vertragsärztlichen Tätigkeit notwendig geworden. LANR und BSNR sind seit dem 1. Juli 2008 gültig und ersetzen gemeinsam die alten KV-Abrechnungsnummern. </xs:documentation> <xs:appinfo> <Kommentar> Werte dieses Typs sollten in Fachverfahren über eine geeignete Schlüsselprüfung validiert werden. </Kommentar> </xs:appinfo> </xs:annotation> <xs:restriction base="xs:string"> <xs:minLength value="9"/> <xs:maxLength value="9"/> <xs:pattern value="[0-9]+"/> </xs:restriction> </xs:simpleType></pre>												

simpleType Logische_Version_Stp

namespace	GI4X:/xml-schema/GI4X-basis/2.0
type	restriction of xs:string
properties	base xs:string

used by	attributes Wurzel_Ctp/@logische_version logische_version
facets	Kind Value Annotation pattern <code>[1-9][0-9]{0,2}\.(0 [1-9][0-9]{0,2})\.(0 [1-9][0-9]{0,2})</code>
annotation	documentation Logische Versionsversion nach XML Richtlinie appinfo <Kommentar>Die Einschränkung erlaubt Werte >= 1.0.0 als logische Version</Kommentar>
source	<pre><xs:simpleType name="Logische_Version_Stp" dd:category="Richtlinie / Metadaten"> <xs:annotation> <xs:documentation>Logische Versionsversion nach XML Richtlinie</xs:documentation> <xs:appinfo> <Kommentar>Die Einschränkung erlaubt Werte >= 1.0.0 als logische Version</Kommentar> </xs:appinfo> </xs:annotation> <xs:restriction base="xs:string"> <xs:pattern value="[1-9][0-9]{0,2}\.(0 [1-9][0-9]{0,2})\.(0 [1-9][0-9]{0,2})"/> </xs:restriction> </xs:simpleType></pre>

simpleType Nachname_Stp

namespace	GI4X:/xml-schema/GI4X-basis/2.0
type	restriction of GI4X-basis:ISO88591_Stp
properties	base GI4X-basis:ISO88591_Stp
used by	element Name_Ctp/Nachname simpleType Name_Stp
facets	Kind Value Annotation minLength 1 maxLength 50 pattern <code>[&#x0020;-&#x00FF;]+</code>
annotation	documentation Dieser Datentyp modelliert den Nachnamen einer Person.
source	<pre><xs:simpleType name="Nachname_Stp" dd:category="Name"> <xs:annotation> <xs:documentation>Dieser Datentyp modelliert den Nachnamen einer Person.</xs:documentation> </xs:annotation> <xs:restriction base="GI4X-basis:ISO88591_Stp"> <xs:minLength value="1"/> <xs:maxLength value="50"/> </xs:restriction> </xs:simpleType></pre>

simpleType Namenstitel_Stp

namespace	GI4X:/xml-schema/GI4X-basis/2.0
-----------	---------------------------------

type	restriction of G14X-basis:ISO88591_Stp
properties	base G14X-basis:ISO88591_Stp
used by	element Name_Ctp/Titel simpleType Titel_Stp
facets	Kind Value Annotation minLength 1 maxLength 20 pattern [-ÿ]+
annotation	documentation Dieser Datentyp modelliert den Namenstitel einer Person.
source	<pre><xs:simpleType name="Namenstitel_Stp" dd:category="Name"> <xs:annotation> <xs:documentation>Dieser Datentyp modelliert den Namenstitel einer Person.</xs:documentation> </xs:annotation> <xs:restriction base="G14X-basis:ISO88591_Stp"> <xs:minLength value="1"/> <xs:maxLength value="20"/> </xs:restriction> </xs:simpleType></pre>

simpleType Namensvorsatz_Stp

namespace	G14X/xml-schema/G14X-basis/2.0
type	restriction of G14X-basis:ISO88591_Stp
properties	base G14X-basis:ISO88591_Stp
used by	element Name_Ctp/Namensvorsatz simpleType Vorsatzwort_Stp
facets	Kind Value Annotation minLength 1 maxLength 20 pattern [-ÿ]+
annotation	documentation Dieser Datentyp modelliert den Namensvorsatz einer Person. Die erlaubten Werte sind durch Anlage 6 DEÜV vorgegeben. appinfo <Kommentar>Dieser Datentyp wird aufgrund der sich häufiger ändernden Schlüsseltable nicht über eine Enumeration der erlaubten Werte in XML Schema geprüft.</Kommentar> <Beispiele>Graf</Beispiele>
source	<pre><xs:simpleType name="Namensvorsatz_Stp" dd:category="Name"> <xs:annotation> <xs:documentation>Dieser Datentyp modelliert den Namensvorsatz einer Person. Die erlaubten Werte sind durch Anlage 6 DEÜV vorgegeben.</xs:documentation> <xs:appinfo> <Kommentar>Dieser Datentyp wird aufgrund der sich häufiger ändernden Schlüsseltable nicht über eine Enumeration der erlaubten Werte in XML Schema geprüft.</Kommentar> <Beispiele>Graf</Beispiele> </xs:appinfo> </xs:annotation> <xs:restriction base="G14X-basis:ISO88591_Stp"></pre>

	<pre> <xs: minLength value="1"/> <xs: maxLength value="20"/> </xs: restriction> </xs: simpleType> </pre>
--	--

simpleType Namenszusatz_Stp

namespace	GI4X:/xml-schema/GI4X-basis/2.0												
type	restriction of GI4X-basis:ISO88591_Stp												
properties	base GI4X-basis:ISO88591_Stp												
used by	element Name_Ctp/Namenszusatz simpleType Namenszusatz_Stp												
facets	<table border="1"> <thead> <tr> <th>Kind</th> <th>Value</th> <th>Annotation</th> </tr> </thead> <tbody> <tr> <td>minLength</td> <td>1</td> <td></td> </tr> <tr> <td>maxLength</td> <td>20</td> <td></td> </tr> <tr> <td>pattern</td> <td>[&#x0020;-&#x00FF;]+</td> <td></td> </tr> </tbody> </table>	Kind	Value	Annotation	minLength	1		maxLength	20		pattern	[-ÿ]+	
Kind	Value	Annotation											
minLength	1												
maxLength	20												
pattern	[-ÿ]+												
annotation	documentation Dieser Typ modelliert den Namenszusatz einer Person. Die erlaubten Werte sind durch Anlage 7 DEÜV vorgegeben. appinfo <Kommentar>Dieser Datentyp wird aufgrund der sich häufiger ändernden Schlüsseltabelle nicht über eine Enumeration der erlaubten Werte in XML Schema geprüft.</Kommentar> <Beispiele/>												
source	<pre> <xs: simpleType name="Namenszusatz_Stp" dd: category="Name"> <xs: annotation> <xs: documentation>Dieser Typ modelliert den Namenszusatz einer Person. Die erlaubten Werte sind durch Anlage 7 DEÜV vorgegeben.</xs: documentation> <xs: appinfo> <Kommentar>Dieser Datentyp wird aufgrund der sich häufiger ändernden Schlüsseltabelle nicht über eine Enumeration der erlaubten Werte in XML Schema geprüft.</Kommentar> <Beispiele/> </xs: appinfo> </xs: annotation> <xs: restriction base="GI4X-basis:ISO88591_Stp"> <xs: minLength value="1"/> <xs: maxLength value="20"/> </xs: restriction> </xs: simpleType> </pre>												

simpleType Ort_Stp

namespace	GI4X:/xml-schema/GI4X-basis/2.0									
type	restriction of GI4X-basis:ISO88591_Stp									
properties	base GI4X-basis:ISO88591_Stp									
used by	element Anschrift_Ctp/Ort									
facets	<table border="1"> <thead> <tr> <th>Kind</th> <th>Value</th> <th>Annotation</th> </tr> </thead> <tbody> <tr> <td>minLength</td> <td>1</td> <td></td> </tr> <tr> <td>maxLength</td> <td>34</td> <td></td> </tr> </tbody> </table>	Kind	Value	Annotation	minLength	1		maxLength	34	
Kind	Value	Annotation								
minLength	1									
maxLength	34									

	pattern [­ -­ÿ]+
annotation	<p>documentation Das Element Ort enthält den Namen eines Ortes (Gemeinde, Ortschaft oder Stadt).</p> <p>appinfo <Kommentar> Als Ortsname sollte der amtliche Gemeindefname genutzt werden. </Kommentar></p> <p><Beispiele/></p>
source	<pre><xs:simpleType name="Ort_Stp" dd:category="Anschri ft / Adresse"> <xs:annotation> <xs:documentation>Das Element Ort enthält den Namen eines Ortes (Gemeinde, Ortschaft oder Stadt). </xs:documentation> <xs:appinfo> <Kommentar> Als Ortsname sollte der amtliche Gemeindefname genutzt werden. </Kommentar> <Beispiele/> </xs:appinfo> </xs:annotation> <xs:restriction base="GI4X-basis:IS088591_Stp"> <xs:minLength value="1"/> <xs:maxLength value="34"/> </xs:restriction> </xs:simpleType></pre>

simpleType Postleitzahl_DE_Stp

namespace	GI4X:/xml-schema/GI4X-basis/2.0												
type	restriction of GI4X-basis:Postleitzahl_Stp												
properties	<p>final #all</p> <p>base GI4X-basis:Postleitzahl_Stp</p>												
facets	<table border="1"> <thead> <tr> <th>Kind</th> <th>Value</th> <th>Annotation</th> </tr> </thead> <tbody> <tr> <td>minLength</td> <td>5</td> <td></td> </tr> <tr> <td>maxLength</td> <td>5</td> <td></td> </tr> <tr> <td>pattern</td> <td>[0-9]+</td> <td></td> </tr> </tbody> </table>	Kind	Value	Annotation	minLength	5		maxLength	5		pattern	[0-9]+	
Kind	Value	Annotation											
minLength	5												
maxLength	5												
pattern	[0-9]+												
annotation	<p>documentation Eine genau 5 stellige deutsche Postleitzahl</p> <p>appinfo <Kommentar>Sollte als Einschränkung von 'Postleitzahl_Stp' verwendet werden, falls die Verwendung ausschliesslich deutsche Postleitzahlen zulässt.</Kommentar></p> <p><Beispiele>64331</Beispiele></p>												
source	<pre><xs:simpleType name="Postleitzahl_DE_Stp" final="#all" dd:category="Anschri ft / Adresse"> <xs:annotation> <xs:documentation>Eine genau 5 stellige deutsche Postleitzahl </xs:documentation> <xs:appinfo> <Kommentar>Sol lte als Einschränkung von ' Postleitzahl_Stp' verwendet werden, falls die Verwendung ausschli esslich deutsche Postleitzahlen zul ässt. </Kommentar> <Beispiele>64331</Beispiele> </xs:appinfo> </xs:annotation></pre>												

	<pre><xs:restriction base="GI4X-basis:Postleitzahl_Stp"> <xs:minLength value="5"/> <xs:maxLength value="5"/> <xs:pattern value="[0-9]+" /> </xs:restriction> </xs:simpleType></pre>
--	---

simpleType Postleitzahl_Stp

namespace	GI4X:/xml-schema/GI4X-basis/2.0												
type	restriction of GI4X-basis:ISO88591_Stp												
properties	base GI4X-basis:ISO88591_Stp												
used by	element Anschrift_Ctp/Postleitzahl simpleTypes PLZ_Stp Postleitzahl_DE_Stp												
facets	<table border="1"> <thead> <tr> <th>Kind</th> <th>Value</th> <th>Annotation</th> </tr> </thead> <tbody> <tr> <td>minLength</td> <td>1</td> <td></td> </tr> <tr> <td>maxLength</td> <td>10</td> <td></td> </tr> <tr> <td>pattern</td> <td>[&#x002D;&#x00FF;]+</td> <td></td> </tr> </tbody> </table>	Kind	Value	Annotation	minLength	1		maxLength	10		pattern	[-ÿ]+	
Kind	Value	Annotation											
minLength	1												
maxLength	10												
pattern	[-ÿ]+												
annotation	<p>documentation Eine Postleitzahl ist eine Angabe, um postalische Zustellgebiete unabhängig von Gebietskoerperschaften (Gemeinde, Kreis, ...) zu bezeichnen.</p> <p>appinfo <Kommentar> In Deutschland sind durch Postleitzahlen bezeichnete Bereiche und verwaltungspolitische Grenzen in der Regel aufeinander abgestimmt. Größere Gemeinden und Städte sind häufig in mehrere Postleitzahlengebiete aufgeteilt. Postleitzahlen werden durch die Deutsche Post AG verwaltet. Eine Beschränkung auf deutsche Postleitzahlen (5-stellig) wurde bewusst nicht vorgenommen. Für diese existiert die Einschränkung 'Postleitzahl_DE_Stp'. </Kommentar> <Beispiele>64331</Beispiele></p>												
source	<pre><xs:simpleType name="Postleitzahl_Stp" dd:category="Anschrift / Adresse"> <xs:annotation> <xs:documentation>Eine Postleitzahl ist eine Angabe, um postalische Zustellgebiete unabhängig von Gebietskoerperschaften (Gemeinde, Kreis, ...) zu bezeichnen. </xs:documentation> <xs:appinfo> <Kommentar> In Deutschland sind durch Postleitzahlen bezeichnete Bereiche und verwaltungspolitische Grenzen in der Regel aufeinander abgestimmt. Größere Gemei nden und Städte sind häufig in mehrere Postleitzahlengebiete aufgeteilt. Postleitzahlen werden durch die Deutsche Post AG verwaltet. Eine Beschränkung auf deutsche Postleitzahlen (5-stellig) wurde bewusst nicht vorgenommen. Für diese existiert die Einschränkung 'Postleitzahl_DE_Stp' . </Kommentar> <Beispiel e>64331</Beispiel e> </xs:appinfo> </xs:annotation> <xs:restriction base="GI4X-basis:ISO88591_Stp"> <xs:minLength value="1"/> <xs:maxLength value="10"/> </xs:restriction> </xs:simpleType></pre>												

simpleType Rufnummer_Stp

namespace	GI4X:/xml-schema/GI4X-basis/2.0												
type	restriction of GI4X-basis:ISO88591_Stp												
properties	base GI4X-basis:ISO88591_Stp												
used by	simpleTypes Mobiltelefon_Stp Telefax_Stp Telefon_Stp												
facets	<table border="1"> <thead> <tr> <th>Kind</th> <th>Value</th> <th>Annotation</th> </tr> </thead> <tbody> <tr> <td>minLength</td> <td>1</td> <td></td> </tr> <tr> <td>maxLength</td> <td>20</td> <td></td> </tr> <tr> <td>pattern</td> <td>[&#x0020;-&#x00FF;]+</td> <td></td> </tr> </tbody> </table>	Kind	Value	Annotation	minLength	1		maxLength	20		pattern	[-ÿ]+	
Kind	Value	Annotation											
minLength	1												
maxLength	20												
pattern	[-ÿ]+												
annotation	<p>documentation Datentyp zur Repräsentation numerischer Rufnummern, z.Bsp als Telefonnummer oder Faxnummer.</p> <p>appinfo <Kommentar>Wegen der unterschiedlichen Formate für die Repräsentation von Rufnummern wird hier auf eine Prüfung, z. Bsp. nach DIN 5008 verzichtet.</Kommentar></p>												
source	<pre><xs:simpleType name="Rufnummer_Stp" dd:category="Kommunikation"> <xs:annotation> <xs:documentation>Datentyp zur Repräsentation numerischer Rufnummern, z. Bsp als Telefonnummer oder Faxnummer. </xs:documentation> <xs:appinfo> <Kommentar>Wegen der unterschiedlichen Formate für die Repräsentation von Rufnummern wird hier auf eine Prüfung, z. Bsp. nach DIN 5008 verzichtet.</Kommentar> </xs:appinfo> </xs:annotation> <xs:restriction base="GI4X-basis:ISO88591_Stp"> <xs:minLength value="1"/> <xs:maxLength value="20"/> </xs:restriction> </xs:simpleType></pre>												

simpleType RVNR_Stp

namespace	GI4X:/xml-schema/GI4X-basis/2.0												
type	restriction of xs:string												
properties	base xs:string												
facets	<table border="1"> <thead> <tr> <th>Kind</th> <th>Value</th> <th>Annotation</th> </tr> </thead> <tbody> <tr> <td>minLength</td> <td>12</td> <td></td> </tr> <tr> <td>maxLength</td> <td>12</td> <td></td> </tr> <tr> <td>pattern</td> <td>[0-9]{8}[A-Z][0-9]{3}</td> <td></td> </tr> </tbody> </table>	Kind	Value	Annotation	minLength	12		maxLength	12		pattern	[0-9]{8}[A-Z][0-9]{3}	
Kind	Value	Annotation											
minLength	12												
maxLength	12												
pattern	[0-9]{8}[A-Z][0-9]{3}												
annotation	<p>documentation Die Rentenversicherungsnummer (RVNR) ist ein aus Buchstaben und Ziffern bestehendes Kennzeichen zur Identifikation von versicherten Personen in der Gesetzlichen Rentenversicherung der Bundesrepublik Deutschland. Die RVNR ist alphanumerisch und 12 stellig.</p>												
source	<pre><xs:simpleType name="RVNR_Stp" dd:category="Identifikationsmerkmale / GKV"> <xs:annotation> <xs:documentation>Die Rentenversicherungsnummer (RVNR) ist ein aus Buchstaben und Ziffern bestehendes Kennzeichen zur Identifikation von versicherten Personen in der Gesetzlichen Rentenversicherung der Bundesrepublik Deutschland. </xs:documentation> </xs:annotation> </xs:simpleType></pre>												

	<pre> Die RVNR ist alphanumerisch und 12 stellig. </xs:documentation> </xs:annotation> <xs:restriction base="xs:string"> <xs:minLength value="12"/> <xs:maxLength value="12"/> <xs:pattern value="[0-9]{8}[A-Z][0-9]{3}"/> </xs:restriction> </xs:simpleType> </pre>
--	--

simpleType StaatSchluessel_Stp

namespace	GI4X:/xml-schema/GI4X-basis/2.0						
type	restriction of xs:string						
properties	base xs:string						
facets	<table border="1"> <thead> <tr> <th>Kind</th> <th>Value</th> <th>Annotation</th> </tr> </thead> <tbody> <tr> <td>pattern</td> <td>[0-9]{3}</td> <td></td> </tr> </tbody> </table>	Kind	Value	Annotation	pattern	[0-9]{3}	
Kind	Value	Annotation					
pattern	[0-9]{3}						
annotation	<p>documentation</p> <p>Schlüssel nach Anlage 8 DEÜV</p>						
source	<pre> <xs:simpleType name="StaatSchluessel_Stp" dd:category="Verschiedenes"> <xs:annotation> <xs:documentation>Schlüssel nach Anlage 8 DEÜV</xs:documentation> </xs:annotation> <xs:restriction base="xs:string"> <xs:pattern value="[0-9]{3}"/> </xs:restriction> </xs:simpleType> </pre>						

simpleType Strasse_Stp

namespace	GI4X:/xml-schema/GI4X-basis/2.0												
type	restriction of GI4X-basis:ISO88591_Stp												
properties	base GI4X-basis:ISO88591_Stp												
used by	element Anschrift_Ctp/Strasse												
facets	<table border="1"> <thead> <tr> <th>Kind</th> <th>Value</th> <th>Annotation</th> </tr> </thead> <tbody> <tr> <td>minLength</td> <td>1</td> <td></td> </tr> <tr> <td>maxLength</td> <td>55</td> <td></td> </tr> <tr> <td>pattern</td> <td>[&#x0020;-&#x00FF;]+</td> <td></td> </tr> </tbody> </table>	Kind	Value	Annotation	minLength	1		maxLength	55		pattern	[-ÿ]+	
Kind	Value	Annotation											
minLength	1												
maxLength	55												
pattern	[-ÿ]+												
annotation	<p>documentation</p> <p>Als Straßename bezeichnet man den Namen, den eine Straße zur Unterscheidung von anderen Straßen trägt. Straßennamen im weiteren Sinne sind dabei auch die Namen von Plätzen und Brücken</p> <p>appinfo</p> <p><Kommentar></p> <p>Die längste Strasse in Deutschland ist die 'Bischöflich-Geistlicher-Rat-Josef-Zinnbauer-Straße' in Dingolfing</p> <p></Kommentar></p>												
source	<pre> <xs:simpleType name="Strasse_Stp" dd:category="Anschri ft / Adresse"> <xs:annotation> </pre>												

	<pre> <xs:documentation> Als Straßename bezeichnet man den Namen, den eine Straße zur Unterscheidung von anderen Straßen trägt. Straßennamen im weiteren Sinne sind dabei auch die Namen von Plätzen und Brücken </xs:documentation> <xs:appinfo> <Kommentar> Die längste Strasse in Deutschland ist die 'Bi schöfl i ch-Gei stl i cher-Rat-Josef-Zi nnbauer-Straße' in Di ngol fi ng </Kommentar> </xs:appinfo> </xs:annotation> <xs:restriction base="GI4X-basis:ISO88591_Stp"> <xs:minLength value="1"/> <xs:maxLength value="55"/> </xs:restriction> </xs:simpleType> </pre>
--	---

simpleType Versichertenstatus_Stp

namespace	GI4X/xml-schema/GI4X-basis/2.0												
type	restriction of xs:string												
properties	base xs:string												
facets	<table border="1"> <thead> <tr> <th>Kind</th> <th>Value</th> <th>Annotation</th> </tr> </thead> <tbody> <tr> <td>minLength</td> <td>1</td> <td></td> </tr> <tr> <td>maxLength</td> <td>5</td> <td></td> </tr> <tr> <td>pattern</td> <td>[0-9A-Z&#x0020;]{1,5}</td> <td></td> </tr> </tbody> </table>	Kind	Value	Annotation	minLength	1		maxLength	5		pattern	[0-9A-Z]{1,5}	
Kind	Value	Annotation											
minLength	1												
maxLength	5												
pattern	[0-9A-Z]{1,5}												
annotation	<pre> documentation Versichertenstatus (der KVKarte) appinfo <Kommentar>Eine genauere Definition ist wegen der unterschiedlichen Verwendung nicht möglich und den Fachverfahren überlassen.</Kommentar> </pre>												
source	<pre> <xs:simpleType name="Versichertenstatus_Stp" dd:category="Verschiedenes"> <xs:annotation> <xs:documentation>Versichertenstatus (der KVKarte)</xs:documentation> <xs:appinfo> <Kommentar>Eine genauere Definition ist wegen der unterschiedlichen Verwendung nicht möglich und den Fachverfahren überlassen.</Kommentar> </xs:appinfo> </xs:annotation> <xs:restriction base="xs:string"> <xs:minLength value="1"/> <xs:maxLength value="5"/> <xs:pattern value="[0-9A-Z&#x0020;]{1,5}"/> </xs:restriction> </xs:simpleType> </pre>												

simpleType Vorname_Stp

namespace	GI4X/xml-schema/GI4X-basis/2.0
-----------	--------------------------------

type	restriction of GI4X-basis:ISO88591_Stp												
properties	base GI4X-basis:ISO88591_Stp												
used by	element Name_Ctp/Vorname												
facets	<table border="1"> <thead> <tr> <th>Kind</th> <th>Value</th> <th>Annotation</th> </tr> </thead> <tbody> <tr> <td>minLength</td> <td>1</td> <td></td> </tr> <tr> <td>maxLength</td> <td>35</td> <td></td> </tr> <tr> <td>pattern</td> <td>[&#x0020;-&#x00FF;]+</td> <td></td> </tr> </tbody> </table>	Kind	Value	Annotation	minLength	1		maxLength	35		pattern	[-ÿ]+	
Kind	Value	Annotation											
minLength	1												
maxLength	35												
pattern	[-ÿ]+												
annotation	documentation Dieser Datentyp modelliert den Vornamen einer Person.												
source	<pre><xs:simpleType name="Vorname_Stp" dd:category="Name"> <xs:annotation> <xs:documentation>Dieser Datentyp modelliert den Vornamen einer Person.</xs:documentation> </xs:annotation> <xs:restriction base="GI4X-basis:ISO88591_Stp"> <xs:minLength value="1"/> <xs:maxLength value="35"/> </xs:restriction> </xs:simpleType></pre>												

simpleType Waerung_Stp

namespace	GI4X:/xml-schema/GI4X-basis/2.0						
type	restriction of xs:string						
properties	base xs:string						
facets	<table border="1"> <thead> <tr> <th>Kind</th> <th>Value</th> <th>Annotation</th> </tr> </thead> <tbody> <tr> <td>pattern</td> <td>[A-Z]{3}</td> <td></td> </tr> </tbody> </table>	Kind	Value	Annotation	pattern	[A-Z]{3}	
Kind	Value	Annotation					
pattern	[A-Z]{3}						
annotation	documentation 3 stelliger Währungscode nach ISO 4217 appinfo <Beispiele>EUR,USD</Beispiele>						
source	<pre><xs:simpleType name="Waerung_Stp" dd:category="Finanzen / Abrechnung"> <xs:annotation> <xs:documentation>3 stelliger Währungscode nach ISO 4217</xs:documentation> <xs:appinfo> <Beispiele>EUR, USD</Beispiele> </xs:appinfo> </xs:annotation> <xs:restriction base="xs:string"> <xs:pattern value="[A-Z]{3}"/> </xs:restriction> </xs:simpleType></pre>						

simpleType Zahnarztnummer_Stp

namespace	GI4X:/xml-schema/GI4X-basis/2.0
type	restriction of xs:string

properties	base xs:string												
facets	<table border="1"> <thead> <tr> <th>Kind</th> <th>Value</th> <th>Annotation</th> </tr> </thead> <tbody> <tr> <td>minLength</td> <td>7</td> <td></td> </tr> <tr> <td>maxLength</td> <td>9</td> <td></td> </tr> <tr> <td>pattern</td> <td>[0-9]+</td> <td></td> </tr> </tbody> </table>	Kind	Value	Annotation	minLength	7		maxLength	9		pattern	[0-9]+	
Kind	Value	Annotation											
minLength	7												
maxLength	9												
pattern	[0-9]+												
annotation	<p>documentation Für die Zahnarztnummer existiert keine geeignete Einschränkung, außer das sie in GKV Verfahren zwischen 7 und 9 Stellen hat.</p> <p>appinfo <Kommentar> Werte dieses Typs sollten in Fachverfahren über eine geeignete Schlüsselprüfung validiert werden. </Kommentar></p>												
source	<pre><xs:simpleType name="Zahnarztnummer_Stp" dd:category="Identifikationsmerkmale / GKV"> <xs:annotation> <xs:documentation>Für die Zahnarztnummer existiert keine geeignete Einschränkung, außer das sie in GKV Verfahren zwischen 7 und 9 Stellen hat. </xs:documentation> <xs:appinfo> <Kommentar> Werte dieses Typs sollten in Fachverfahren über eine geeignete Schlüsselprüfung validiert werden. </Kommentar> </xs:appinfo> </xs:annotation> <xs:restriction base="xs:string"> <xs:minLength value="7"/> <xs:maxLength value="9"/> <xs:pattern value="[0-9]+"/> </xs:restriction> </xs:simpleType></pre>												

attribute logische_version

namespace	GI4X:/xml-schema/GI4X-basis/2.0						
type	GI4X-basis:Logische_Version_Stp						
facets	<table border="1"> <thead> <tr> <th>Kind</th> <th>Value</th> <th>Annotation</th> </tr> </thead> <tbody> <tr> <td>pattern</td> <td>[1-9][0-9]{0,2}\.(0 [1-9][0-9]{0,2})\.(0 [1-9][0-9]{0,2})</td> <td></td> </tr> </tbody> </table>	Kind	Value	Annotation	pattern	[1-9][0-9]{0,2}\.(0 [1-9][0-9]{0,2})\.(0 [1-9][0-9]{0,2})	
Kind	Value	Annotation					
pattern	[1-9][0-9]{0,2}\.(0 [1-9][0-9]{0,2})\.(0 [1-9][0-9]{0,2})						
annotation	<p>documentation Attribut für Logische Versionsversion nach XML Richtlinie. Dieses Attribut muss für die Wurzel von verfahrensspezifischen Nutzdaten verwendet werden, falls diese nicht von 'Wurzel_Ctp' abgeleitet werden können</p>						
source	<pre><xs:attribute name="logische_version" type="GI4X-basis:Logische_Version_Stp" dd:category="Richtlinie / Metadaten"> <xs:annotation> <xs:documentation>Attribut für Logische Versionsversion nach XML Richtlinie. Dieses Attribut muss für die Wurzel von verfahrensspezifischen Nutzdaten verwendet werden, falls diese nicht von 'Wurzel_Ctp' abgeleitet werden können</xs:documentation> </xs:annotation></pre>						

	<code></xs:attribute></code>
--	------------------------------------

XML Schema documentation generated by [XMLSpy](http://www.altova.com/xmlspy) Schema Editor <http://www.altova.com/xmlspy>